

Mounting instruction for Cable transfers:

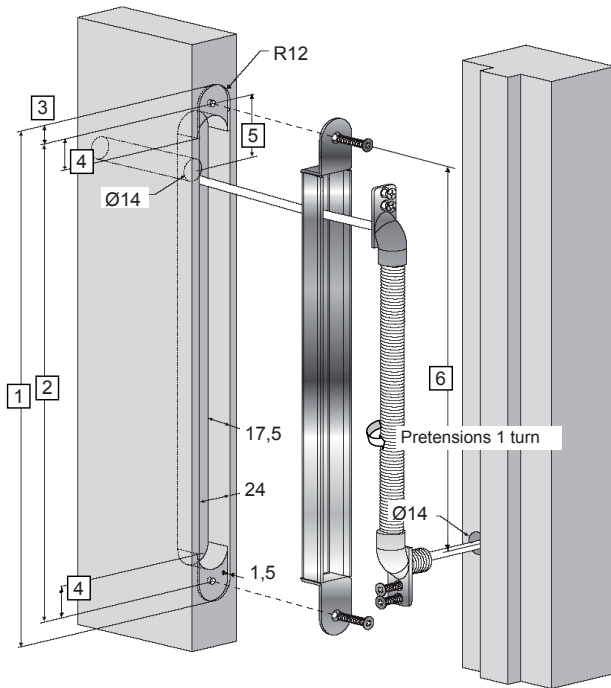

Pos.	Item no	
	904630	904637
1	324	544
2	299	519
3	12	12
4	20.5	20.5
5	C-C40-57	C-C40-57
6	~242	~465

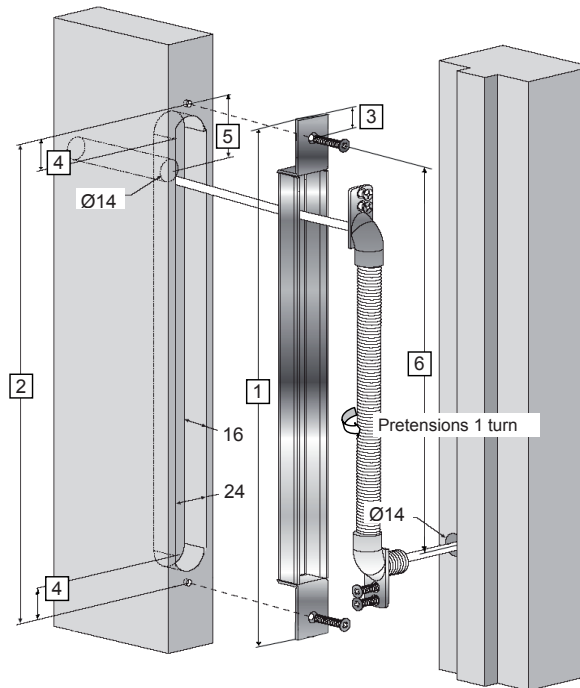

Pos.	Item no	
	904631	904632
1	291	511
2	277	497
3	6.5	6.5
4	9.5	9.5
5	C-C34-46	C-C34-46
6	~231	~454

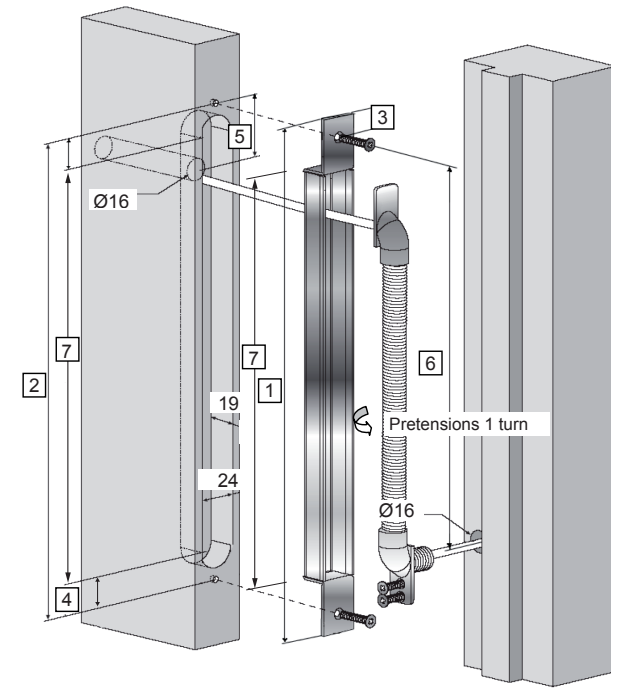

Pos.	Item no	
	929590	
1	521	
2	507	
3	7	
4	(13,5)	
5	C-C 50±5	
6	~455	
7	477	