

ASSA AB
P.O. Box 371
SE-631 05 Eskilstuna
Sweden

phone +46 (0)16 17 70 00
fax +46 (0)16 17 72 10

Customer support:
phone intl. +46 16 17 71 00
fax +46 (0)16 17 73 72
e-mail: helpdesk@assa.se

www.assa.se

ASSA[®]
ASSA ABLOY

ASSA ABLOY, the global leader in door opening solutions, dedicated to satisfying end-user needs for security, safety and convenience

ASSA mini catalogue

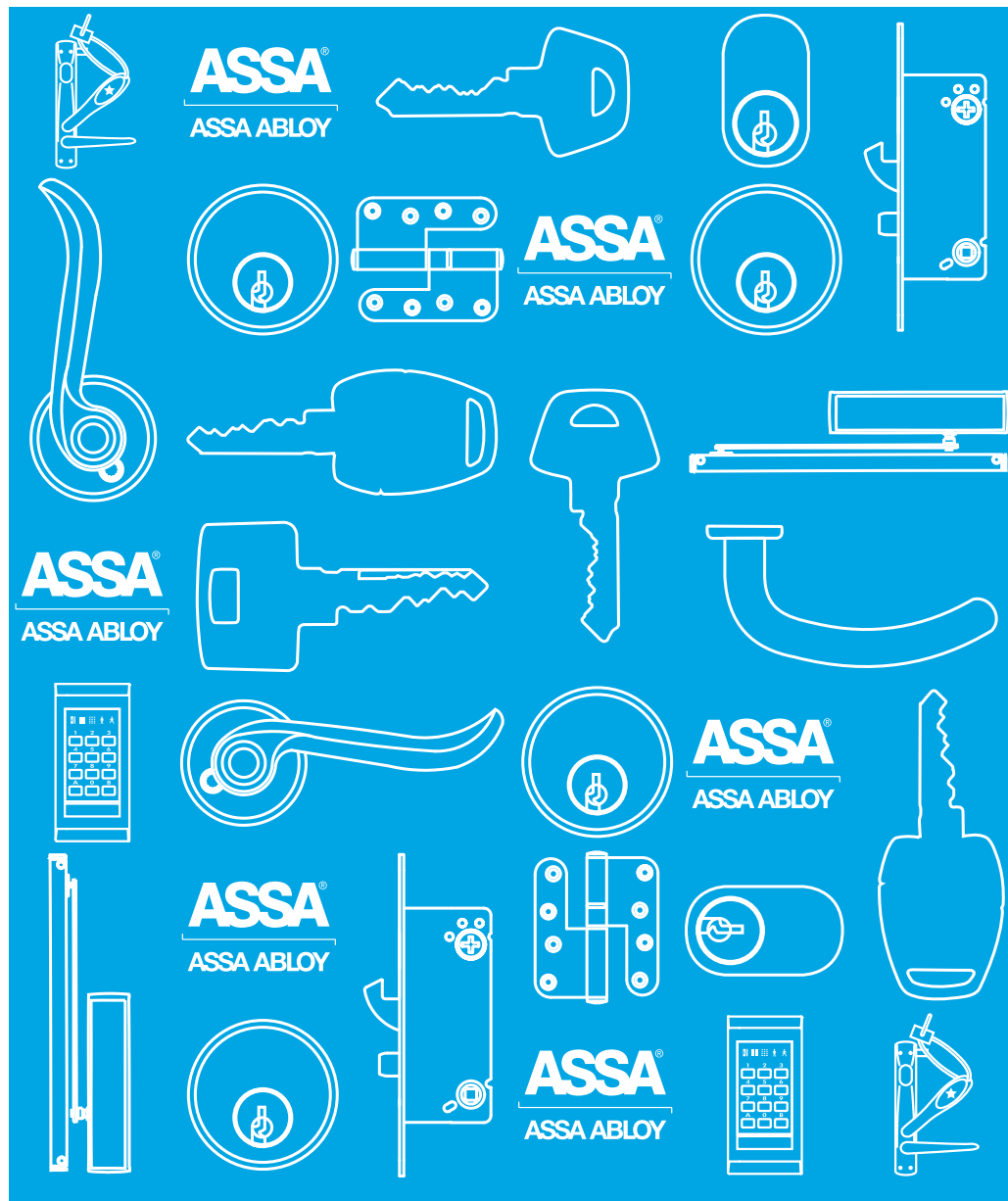

ASSA mini catalogue
Product catalogue

ASSA[®]
ASSA ABLOY

ASSA ABLOY, the global leader
in door opening solutions

ASSA[®]
ASSA ABLOY



ASSA Security on your terms

ASSA is the leading supplier of lock and security solutions for the business and consumer markets.

ASSA is dedicated to satisfying end-users needs for security, safety and convenience.



Dear Customer,

We hereby present the new edition of ASSA Export Catalogue featuring our current range of ASSA products.

The catalogue contains new and existing products from ASSA AB, RUKO and ASSA OEM.

For products featured on the ASSA AB pages, please contact the ASSA AB Export department. For products featured in the ASSA OEM pages and RUKO pages, please turn to the ASSA OEM and RUKO Export departments.

In addition to the content in this catalogue, information and news are published on a regular basis on our websites: www.assa.se, www.ruko.dk and www.assaonem.se.

We at ASSA are committed to listening to you, our customer, in order to improve our service. We appreciate your business and value any feedback on our service and regarding future product needs. We will appreciate any input from you.

Please feel free to browse our new ASSA Export Catalogue. We are looking forward to doing business with you and wish you welcome to our updated and extended world of door-opening products.

Best regards

Urban Doverholt
Managing Director
ASSA AB



Urban Doverholt
Managing Director
ASSA AB

ASSA[®]

ASSA ABLOY



The customer

We work to the specifications of the system owner and system manager. Our policy is to design your security solution based on the needs and requirements of your operations.

ASSA the security company

Developing, designing and manufacturing top-quality locks and security products are key elements of ASSA's operations. We are also a knowledge-intensive company that continuously monitors and drives the development of lock and security issues. ASSA's resources, combined with the excellent work of local lock retailers, ensure that the system owner is offered the right quality in every assignment.

Security contractors and lock retailers

These companies have the expertise and provide nationwide distribution of products and services. Several of them have businesses covering everything from security analyses to installation and follow-up service.

Security requirements

Security requirements are determined in part by the demands of the system owner and in part by insurance companies and fire authorities. Standards and rules from the Swedish Building Standards Institution also affect the final solution.

Properties of a security solution

A modern security solution is planned with a platform using online and offline products for full flexibility and security. The aesthetic design, user friendliness and overall economy of the system are also a part of this.

Object-specific solutions

If you'd like to know more, visit our website, www.assa.se, for alternative object and product solutions.

Contact information

For information about pages 48-463, contact:

ASSA AB

P.O. Box 371
SE-631 05 Eskilstuna
Sweden
phone +46 (0)16 17 70 00
fax +46 (0)16 17 72 10

Customer support:
phone +46 (0) 771 640 640
fax +46 (0)16 17 73 72
e-mail: helpdesk@assa.se

www.assa.se

For information about pages 464-483, contact:

ASSA OEM AB

Bruksgratan 17
SE-414 51 Göteborg
Sweden
phone +46 (0)31 704 40 00
fax +46 (0)31 14 23 55
e-mail: info.fix@assaoem.se

www.assaoem.se

For information about pages 484-489, contact:

ASSA OEM AB

P.O. Box 371
SE-631 05 Eskilstuna
Sweden
phone +46 (0)16 17 70 00
fax +46 (0)16 17 70 18
e-mail: csg@assaoem.se

www.assaoem.se

For information about pages 490-501, contact:

ASSA OEM AB

P.O. Box 371
SE-631 05 Eskilstuna
Sweden
phone +46 (0)16 17 70 00
fax +46 (0)16 17 70 18
e-mail: info.etuna@assaoem.se

www.assaoem.se

For information about pages 502-547, contact:

RUKO A/S

Marielundvej 20
DK-62730 Herlev
Denmark
phone +45 4454 4454
fax +45 4454 4444
e-mail: ruko@ruko.dk

www.ruko.dk

ASSA AB

Introduction 2-47

Master key systems.....48-91

Software 92-103

Accessories.....104-187

Lock cases 188-259

Electromechanical locks260-295

Access control systems296-371

Code locks372-379

Door control.....380-425

Hinges.....426-463

ASSA OEM AB

Windows and patio doors.....464-483

ASSA OEM AB

Lever locks484-489

ASSA OEM AB

Industrial locks.....490-501

RUKO A/S

Ruko Line502-547

Register548-559





ASSA – the security company

ASSA is a leading supplier of locks and security solutions for professional customers. We develop, manufacture and market locks and security solutions for doors, windows and cabinets.

Our products are characterized by quality, high security and smart design. Since we began manufacturing locks in the late 1930s we have supplied locks and door furniture for all types of applications to practically all segments, including a wide variety of very prestigious industrial, institutional, military and government enterprises.

ASSA continuously monitors and spearheads the development of lock and security technology, and believes that you, as our customer, are more interested in solutions than individual products.

With our comprehensive range of products and services, we can set up security systems that suit your specific needs, regardless of the segment or business environment in which you operate.

With us you have choices; we call that "Security on your terms".

The ASSA brand

The ASSA brand is internationally well-known in the lock industry and has become synonymous with quality, security and design. ASSA was among the first companies in Sweden to receive ISO 9001 quality certification, and we also hold ISO 14001 environmental certification. Contacts with customers often occur through our international network of retailers. ASSA develops locks and integrated security systems for door environments. ASSA is Sweden's leading supplier of lock and security solutions for the business and consumer markets. Our products are defined by quality, high security and design.



Our cornerstones

Quality

ASSA products are supplied in accordance with well-documented quality procedures. ASSA holds ISO 9001 certification.

Security and design

When your investment in technology, functionality and performance reflects the value of the protected property, you get top-notch security.

Environment

We are committed to the environment and give due consideration to the technical, economic and ecological effects of our operations.

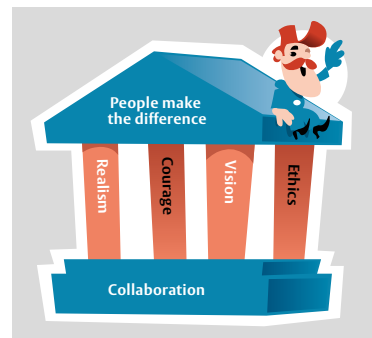

Our history

- 1881 August Stenman buys a small hinge manufacturer in the town of Eskilstuna, Sweden, and starts his company, August Stenman AB.
- 1939 The first cylinder lock is manufactured.
- 1946 The first 5-pin cylinder master key system is delivered.
- 1959 ASSA introduces registered master key systems with key control.
- 1980 ASSA starts manufacturing electromechanical locks.
- 1981 ASSA celebrates 100 years as a company and introduces ASSA Twin – a new cylinder concept that was a success story of its own.
- 1988 ASSA is certified in accordance with ISO 9001.
- 1991 ASSA introduces the ASSA Twin Combi, an enhanced version of the previous Twin cylinder concept.
- 1993 ASSA introduces the Twintronic – an electro-mechanical cylinder that combines access control systems with mechanical master keying.
- 1994 The ASSA ABLOY Group is formed through a merger of Securitas and Metra Oy's ASSA and ABLOY lock businesses.
- 1998 ASSA receives ISO 14001 environmental certification.
- 2001 The ASSA CLIQ is launched.
- 2003 The ASSA Connect modular lock case platform is launched to replace the well-known modular lock case series.
- 2003 The ASSA Evolution is launched to replace the lock housings in the modular series. The following year, the company acquires TT-system (now called ASSA Key Solutions), manufacturers of cabinets for key management and medicine storage.
- 2003 Solid launches Solicard ARX today ASSA ARX access control, built on industry standards for IP network. ASSA ARX have unique solution with patented secure communication over internet.
- 2006 ASSA celebrates 125 years as a company and introduces the ASSA dp – a new cylinder platform with exceptional capabilities based on the same concept as the Twin platform, introduced in 1981, which has been and will remain a key ingredient for success.
- 2010 Aptus acquired 2010. ASSA d12 cylinder series launched 2010.
- 2011 ASSA celebrates 130 years during 2011 and a new door closer range introduced in 2011.
- 2004 A launch of the ASSA ABLOY developed Hi-O technology introduces a new concept for net worked access control and electronic door solutions, in which connected units exchange encrypted information.
- 2005 ASSA AB, Solid AB and Timelox AB merge their marketing divisions to offer custom solutions under the motto: "Everything from hinges to access systems". A new project division is formed.
- 2006 ASSA celebrates 125 years as a company. A completely new mechanical lock platform, ASSA dp, is launched the same year. Solid AB is made a business unit of ASSA AB.
- 2008 A new smart technology - Aperio is launched. This ASSA ABLOY-developed technology enables mechanical locks to be wireless-linked to an existing access control system, making it easy for customers to upgrade their access control systems.
- 2009 ASSA ABLOY celebrates its 15th anniversary. The Group's size is now almost 10 times larger than in 1994. ASSA ABLOY has consolidated the industry and is the world leader in door opening solutions.
- 2010 CLIQ Remote, combines mechanical high-security cylinders with the flexibility in electronics and our experience in access control. The product was an award winner, "The Access Control Product of the Year" at IFSEC 2011.
- 2011 ASSA launches the RX WEB - Fast, easy and cost-effective access control, up to 16 doors.
- 2012 P 600 is launched, built on a new master key system platform.





Designing your security solution
 Depending on the segment or area of use, the security installations will differ due to the different needs and demands of different types of enterprises.

Designing a security installation is a process that requires experience, knowledge and a good understanding of the needs of the enterprise. Understanding how the daily operations work is key to designing a door opening solution that meets crucial demands for safety, convenience and security.

When designing the security solution, we take into account many vital requirements.



The Metropolitan is an office center in Warsaw, designed by Norman Foster. ASSA has over 2.500 cylinders in a Master Key System installed within the building.

Security

Physical security
 Physical security is the foundation of any security solution. Mechanical strength and operational reliability are examples of properties that will impart physical security to your security solution.

Level of security for the solution
 The level of security can vary depending on where in the building the door is located, its function, and the area/people it is intended to protect.

A number of lock classes are available for security solutions intended to protect the major assets of a business, depending on the value in question. Insurance companies and other policymakers often have requirements for high-exposure enterprises in terms of both physical security and security for valuable property.

Access
 How will employees and visitors gain access to the workplace? Which doors will open with which cards or keys, and how will users' authorization be structured to achieve optimal control and administration? How can this be optimized based on how the enterprise functions? Will electronic IDs and/or PINs be required? Will the entryway have touch-free access or an entry phone?

Security zones
 There are often various zones or areas that may be accessible to one category of employees, but not to the rest. The choice of security solution will be affected by parameters such as how large the authorized group is, how rapidly the group changes, how many other groups and safety zones exist, security system maintenance, etc.

Authorization categories can be assigned mechanically and electronically. The connections can be made on line or off line. The optimum security solution must conform to both your business and your buildings.

Time zones
 Do your operations change depending on the time of day? Or from month to month? If your operations follow a schedule, then your security solution must also facilitate that control.

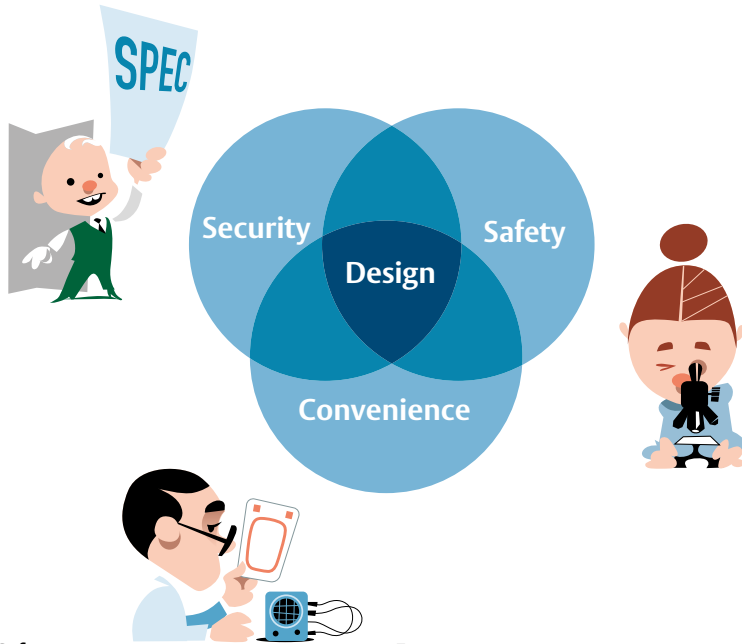

Safety

Emergency or panic exit

Many businesses have some type of requirements for their security solution in the event of an emergency. Responsibility often falls on the system owner of the security solution when a disaster occurs. It must be possible to evacuate sports arenas quickly, emergency escape handles on doors to stairwells must be openable from the other side in the event that the escape path is blocked, etc.

These requirements vary from market to market, and are regulated by international standards. However, the trend is clear: these requirements are becoming increasingly strict, and will soon be harmonized worldwide.

Fire demands

In the event of a fire it is important to ensure that doors are kept closed to prevent fire and smoke from spreading, and to monitor the various escape paths. Locks and fittings are essential components that can affect whether or not a door meets the relevant requirements.

Other doors that, for example, are kept open by means of magnets must be automatically closed by door closers that fulfill corresponding fire-safety requirements.

ASSA also offers numerous products to ensure safe evacuation.

Economy

Investment

A new security solution can be cost-effective if it can be integrated with the existing solution. At the same time, the investment must be recouped in the form of more efficient administration, solid security and perhaps greater ease of use. A major investment can lead to low costs in the long term, while a simple installation may require constant maintenance.

Use and maintenance

A security solution can play an important role in a business; it all depends on the layout of your organization and your buildings.

Your personnel databases can be used for authorization categorization. Your computer network can do more than just accommodate regular data communication; it can also allow integration of building's security products so they can be controlled via the Internet. Smart locks will tell your property supervisor themselves whenever parts or batteries need to be replaced. A single receptionist can serve your company while simultaneously having full control over the flow in your building.

Flexibility

Businesses are constantly changing. Your security solution must be expandable and adaptable, while at the same time meeting your company's security requirements. Upgradeable lock systems are a good long-term financial option if function requirements are likely to increase or change.



Electronic authorization enables flexible security control. Systems with open interfaces make it possible to integrate outside products. Updates can be made via the Internet, or directly at the door.

The flexibility of a security solution depends on many different aspects. ASSA constantly strives to achieve greater flexibility for the customer in the development of hardware and software.

Policies

What regulations and laws apply to security systems in your market? ASSA has long cooperated with government agencies and organizations that set the standards for security solutions. Based on this cooperation, we have continuously developed new products that meet the requirements imposed on us as a supplier of security solutions.

Administration

Key and code administration is often perceived to be a burdensome task, particularly for larger organizations or companies. With the right security solution your company can maintain a high level of security while at the same time

enjoying simple and efficient administration. We have software that can manage your keys and display the number of doors, individuals, time zones, authorization groups, etc. in a clear and easy-to-read interface. We have systems that can be programmed from a portable terminal at the door, and systems that can change the schedules for thousands of doors with a single keystroke.

Function

Your choice of functions for your security system ultimately depends on your company's individual needs. Why not let the key that opens your place of business open other areas or, say, cabinets in your office or display cases in your store? Why not let access cards serve as employee ID cards as well? Or you can plan your security solution so that the cards open not just doors, but computers and other processes as well.

Environmental aspects

Temperature fluctuations, rain and moisture cannot be allowed to affect the function of a security product. We have products that can tolerate extra high temperatures and withstand salt water, high pressure and the full gamut of environmental factors.



Stockholm Globe Arena. ASSA supplied the emergency door actuators and emergency escape handles for hundreds of doors in the building so that it could be evacuated in the event of a panic situation.



Hospitals often require fast, convenient access. ASSAs automatic door openers provide safe, quiet access for frequently used doorways. The use of sterile materials is sometimes required in the security solution as well.

Different companies have different needs

We can provide a solution using standard products regardless of whether you have 5 employees or 5,000, or whether your company requires a large degree of openness or is subject to strict security regulations. Your adaptable and expandable security system will meet the future needs of your business as it changes. The goal is to give you a more efficient security solution in a more convenient and secure workplace, regardless of the conditions.



Safe evacuation, convenient access for personnel retrieving goods from the storeroom, and compact, yet still approved, locks for glass partitions are some of the requirements for shopping malls.

ASSA has helped many international chain stores with equipment standards for their businesses. For example, a Hennes & Mauritz storeroom door in Munich looks the same as one in Paris.

ASSAs access control systems offer more functions than merely restricting/permitting personnel to pass through certain doors – an elevator can also be controlled, or why not the mailboxes for all the employees?



Commercial buildings

Commercial buildings often contain many different types of areas. The extent to which you, as system owner, will get a fully integrated security solution depends entirely on the versatility and range of your security supplier.

For example, a single office complex may contain hundreds of people. The office's perimeter protection must be robust, yet it must still be flexible in terms of authorization. A lock or reader can be connected to a central computer program so that lost keys/cards can be blocked in just a few seconds.

Industrial firms and banks often have areas that are subject to exceptionally strict security requirements, such as server rooms, elevators and electrical distribution boxes. Common areas such as conference rooms can be equipped with digital booking panels, and personnel can use their access cards to pay for lunch at the cafeteria, among other things. Glass partitions and furniture require locks that are compact but can still be integrated with the rest of the security solution, with everything working together to provide optimum administration.

Public buildings

There are many examples of public buildings all around us, including schools, hospitals, cultural and leisure centers, etc. These facilities are characterized by openness and public access. They often play a central role in our communities, and are accessible to the public. Although these buildings are largely characterized by openness, it must still be possible to control and limit access with regard to both time and space.

We also view judicial, criminal detention and military buildings as public buildings. Yet these types of facilities are subject to other specific access and security requirements.

Residential buildings

Residential buildings include everything from private homes to multiunit apartment buildings and student housing complexes.

We offer tailor-made solutions for multi-dwelling residences, with convenient automatic door openers, display and web-based booking functions, entry phones, remote-control garage openers, etc.



Our way to you

The majority of our products are distributed via our established network of sales companies and partners – ideally through security contractors that implement an entire project from the planning phase through installation and service. To ensure that our products and services are maximally effective and that end users get an optimum security solution to meet their needs, it is important for us to maintain a close dialogue with those who determine the specifications for our products, including architects, security consultants, building consultants and fire protection consultants.



ASSA trains lock smiths, end users and other personell in various security matters. The subjects include everything from mechanical security to software and electronics.



ASSAs Helpdesk takes calls from throughout the world every day.



ASSAs test laboratory is an independent test laboratory for product developers in the construction and property management industries. It performs hundreds of tests each year. ASSAs test laboratory knows the re-quire-ments imposed by various standards organizations, insurance companies, and customers.

We license our partners for your safety
To be qualified to plan, install and service mechanical lock systems and electromechanical products, the technician must complete advanced training at the ASSA Security School.

The course of instruction ranges from basic mechanical knowledge to advanced network installation and programming. The ASSA Security School also teaches its graduates to be businesslike and professional.

Upon successfully completing the training program, students receive a certificate confirming that they possess the skills necessary to work with ASSA products.

Security centers
ASSA Security centers comprise our network of security specialists. They can help you with everything from copying a single key to developing a complete security plan for your business. Regardless of your needs, ASSA Security centers are a security supplier that meets strict requirements in terms of professional know-how, just as the name indicates.

ASSA on the Internet or by phone
ASSA answers many security questions on its website at www.assa.se, but expert help from ASSA Helpdesk is never more than a phone call away. Our staff assists private customers, professional users and installers. Architects have their own hotline at ASSA. We can help with lock equipment for entire buildings, and with questions regarding evacuation and government requirements. The ASSA Project department can draw up a lock diagram for you, or plan an entire hospital. Take a look at our references, and you'll see that there are no limits to what we can do.

ASSA Testing Laboratory
We have a certified test laboratory at our plant in Sweden. Our products are thoroughly tested and documented here before they are released on the market. Because the lab is certified and independent, we also perform testing at the request of security institutions and industry organizations.



ASSA product range

Do you want to secure the future of your security solution? Statutory requirements and demands from the business community and industry on lock and security systems have escalated dramatically in recent years. Given the current pace of change in the world, of course you want the technology you buy today to be flexible enough to adapt to tomorrow's needs and possibilities.



Developing solutions like ours takes know-how. ASSA has over one hundred years of experience designing products for doors and windows. One lesson we have learned over time is that the future is in intelligent system solutions.

As one of the world's leading and most comprehensive security companies, ASSA has strong product development resources. Our strategy is to develop new solutions based on the technology you have already invested in, and to guarantee that you can obtain service whenever you need it.

Do you want to secure the future of your security systems? If so, ASSA is a safe choice.

True beauty arises from functional perfection

Must aesthetics be sacrificed when security demands are stringent?

Not at all. On the contrary: the more extensive the security system, the more important design becomes. Locks, accessories, hinges and handles must all speak with one voice. When all the details fit together and are integrated with the larger design, the quality is apparent to the eye.

The door handle gives character not just to the door but also to the interior design. Models for everyday applications are pleasing to eye and hand. For more exclusive environments we have a whole range of handles, modern in conception, made of stainless steel or in a variety of finishes. To match the spirit of existing buildings, we have designs inspired by all periods of the twentieth century.

Functionality for everyone

The beauty of an everyday object resides largely in its function. Pull handles, lever handles and knobs must fulfil their intended function smoothly and easily. This is particularly important in buildings used by the elderly, children, or the handicapped. In escape routes functionality is absolutely essential; in a fire, people's lives may depend on being able to get out easily.



The Westin hotel in Warsaw invested in a security solution consisting of mechanical and electromechanical lock cases, a Master Key System, card readers and panic exit devices.



It's all about key control

The lock cylinder is central to ASSA's security philosophy, like key control and the ability to build Master Key Systems for enterprises of all sizes are a fundamental core competence.

The cylinder, together with the lock case and accessories, also enables you to select the right level of security in the right place.

We have built a range of electromechanical and electronic support systems based on the cylinder. We guarantee that you can obtain service and additional installations whenever you need them, and that your Master Key System will be future-proof.



Different cylinders in the same system

ASSA pin cylinders are noted for their high quality, but their unique feature is their flexibility. The cylinders, lock cases and accessories offer you a choice for the right level security in different areas of your enterprise and offices. Created by a leading developer of high-security lock cylinders, our products offer powerful protection against unauthorized entry as well as protection against picking, drilling and forcing.

Key control

ASSA has developed a unique concept of key control that lets you protect keys and control access as illustrated in our "Security Pyramid". A single lock system can be adapted to different security levels depending on the property to be protected. The level of key control determines the security level of each lock. Lost or stolen keys can also be easily disabled.

Having the right security in the right place makes good business sense

Lock security and economy are two sides of the same coin. The secret to an economical solution is having the right security in the right place. When your investment in technology, functionality and performance reflects the value of the protected property, you have the right security. This sounds simple, but identifying the right investment is also a matter of determining the best possible total economy in the longer term.

By investing in a system whose components are easy to replace and modify for future needs, with no compromises in security and design, you can achieve big savings. This is the kind of solution ASSA can offer you.

Access control

Our electromechanical system lets you register the use of the keys and grant limited access at certain times. The system can also be complemented with an access control system that uses cards and card readers to maximize access control. But at its core, ASSA is still a leading developer of high-security lock cylinders. With key control and the cylinders' built-in resistance to picking, drilling and forcing, they afford powerful protection. Our product range includes lock cylinders for all purposes and all levels of security. All you have to provide is the door and frame. Or not even that: our industrial locks protect anything from cabinets to vending machines to safe deposit boxes to mailboxes.

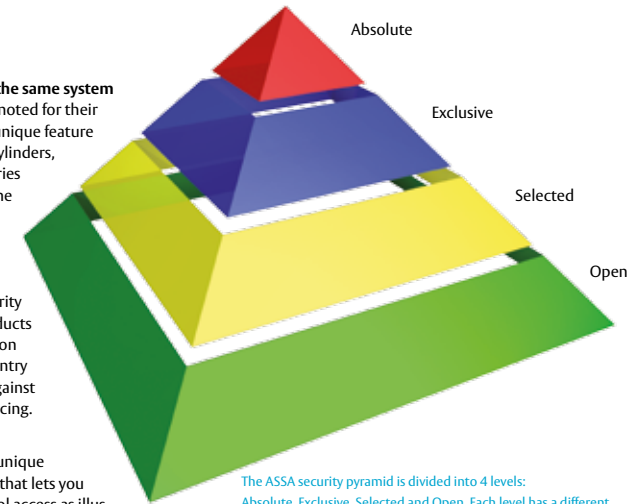

The ASSA security pyramid is divided into 4 levels: Absolute, Exclusive, Selected and Open. Each level has a different package of products, services and distribution philosophy. Regardless of the type of project, ASSA can offer a tailor-made solution based on your specific needs and demands.



Our product range includes lock cylinders for all purposes and all levels of security.



Electromechanical locks

Allow us to introduce our new intelligent lock system that combines the best engineering and electronics in the smartest possible way. We call this technology CLIQ™.

CLIQ technology is built into a new generation of ASSA dp lock cylinders that can be combined in a Master Key System.

The ASSA dp CLIQ Master Key System guarantees security despite changes that may be made in the system, such as augmentation or multiple key distributions.

The ASSA dp CLIQ gives you control over all keys, can easily be upgraded and can be tailored to meet the needs of any enterprise or organization.

No wiring – just install

The dp CLIQ was developed based on the renowned ASSA dp cylinders. They offer all the same high-quality, proven mechanical security, tested and approved by insurance companies. Unlike existing electronic and electromechanical lock technology, dp CLIQ systems do not require wiring, an external power source or extra equipment of any kind. Just take it out of the box and install.

Keys with double technology

The dp CLIQ key has the same type of mechanical coding as an ASSA dp key: a system code and a side code. The key also has an electronic code programmed into a memory chip in the key bow. The memory chip provides an electronic ID that complements the mechanical system code.



Electromechanical blocking

The cylinder has a built-in electronics package. This package communicates with the electronics in the key and activates a small electronic motor that drives a mechanical blocking element, which locks the side bar. All of these components are integrated in the lock cylinder and are well protected against manipulation.

High safety standard

The dp CLIQ cylinders are classified as SS 3522/EN 1303 (in accordance with the new European norm), which means that the cylinders can be included in approved lock units of class 3 in a system devised by insurance companies. In addition, the keys are also protected by a patent.

A key with built-in intelligence

A chip with both memory and a processor lies inside the ergonomically designed key bow. The memory includes encrypted codes as well as the key's unique identity. All access codes are based on the proven DES encoding standard.

The same intelligence is integrated into the cylinder

A matching chip, also with memory, a processor and operating electronics unit, is built into the cylinder. It contains a corresponding program and encrypted codes, allowing it to communicate with the key.

The electronics unit drives an electric motor that maneuvers the mechanical blocking element. A battery that not only drives the processor in the key but also the processor and motor in the cylinder is located in the key bow.

All information is transferred by the keys

The system manager uses a "C-key", which is a programming key that activates the keys and programs the cylinders. Access information is transferred from the C-key to the cylinder. When the user puts the key into the cylinder, a process is initiated to determine if the key has the proper authorization, all within a few tenths of a second.

All of the keys in the system are programmed using our ASSA Performer software. It's easy to use, has a graphic interface with easily interpreted symbols and is PC-compatible.

Interactive intelligence ties the system together

CLIQ makes it possible to create intelligent, flexible and high security lock systems. The key's mechanical engineering creates the basic foundation made up of different security zones in the same way as in mechanical lock systems. The electronic programming of the keys gives authorization to individuals or groups.

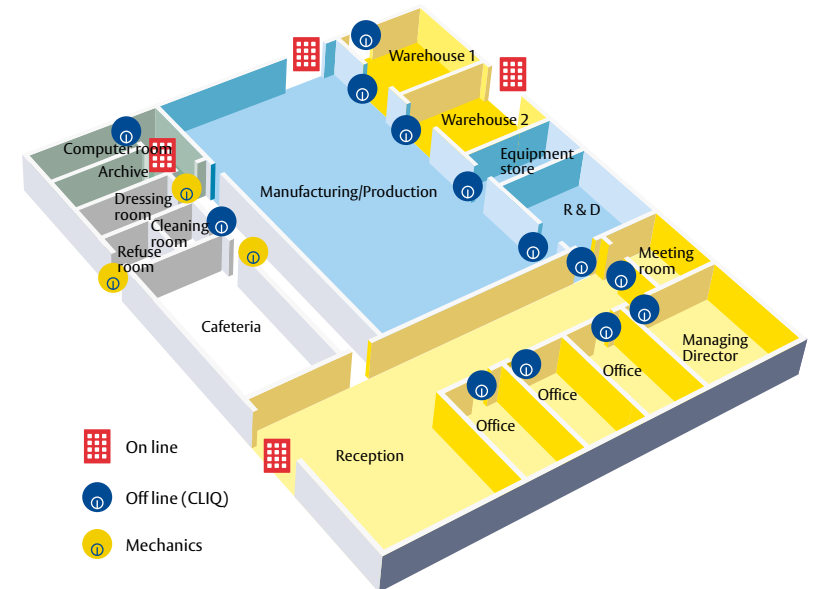



Stand-alone readers

ASSA stand-alone readers are code or card readers that are suitable for doors that do not require high-security solutions.

Our newest stand-alone reader can be upgraded from a compact low-security reader to a smart on line reader, which is perfect for customers who want to be able to grow – and to take their security solution with them!

A stand-alone reader can be programmed directly via its keypad, or from a portable terminal.



Code or card readers for easy installation

Stand-alone readers are easy to install, because they don't need to be connected to an external system. There are two different basic constructions: compact and split installation. See the application example on the bottom of this page.

ASSA has readers with both compact and split installation.

One door today – many more tomorrow

Stand-alone readers are used for on individual doors in a facility, for instance in situations where many people must have access to a building, but where the need for central administration is not particularly great.

Program using the keypad or a portable computer

Stand-alone readers can be programmed directly, using the keypad, or via a portable computer. Block cards, enter new cards – you can do it all with the keypad.

From off line to on line

Systems are often expanded gradually. Some systems evolve as the enterprise grows. Regardless of your situation, ASSA's newest stand-alone reader, the PCR-40, ensures that you will be able to upgrade, since the reader can easily be linked with others to form a larger network of readers (see Access control systems – on line).



A gym membership card can be used to gain access from a stand-alone reader. The reader stores all schedules and validity times in its own memory.



Compact installation

When the reader and control unit are installed on the outside of the door, this is known as a "compact installation." This solution is often easy to install, but provides lower security because the reader and the control unit are in the same location.

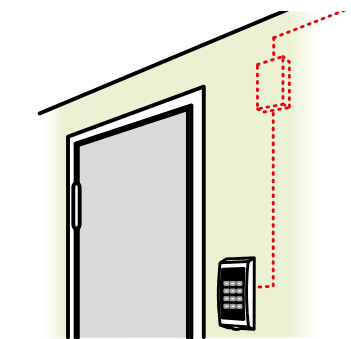

Split installation

"Split installation" means that the reader and the control unit are located on opposite sides of the door—the reader on the outside and the control unit on the inside. This provides greater security than a compact installation, but also requires more time to install.



ASSAs on line system, ARX Access, can be controlled in real time over an existing network or the Internet. One system gives you complete control over an unlimited number of doors and people.

Access control systems – on line

With on line systems you can centralize administration and control access to buildings all over the world. Changes made in the system, on schedules, access rights and so on, are immediately implemented for all doors and users.

With central units that can be connected to the existing network in a building, you have the advantage of less cabling, resulting in a quicker and easier setup process.

The software offers extensive functionality, but you only pay for the functions you use. This allows your organization and system to grow and adapt to changes over time.



Immediate impact – all around the world

On line systems are the most flexible way to control who goes where, when. Discover the convenience of updating access over the Internet, with immediate effect for users. Block cards, add new users, or check the week's event log right on your laptop – no matter where you are!

ASSAs online access control system – ARX Access

Its two main parts, the software package and the hardware, form the access control system. The ARX Access system provides all necessary hardware, from readers and door-opener buttons at the door to control units in the system backbone. ARX Access consists of a client for administration and a server application that manages the hardware in the system.

Endless possibilities

The system is built on open industry standards, making it future-proof and providing the possibility for other service providers to integrate with ARX. One example of an integrated solution is the Galaxy burglary alarm from Honeywell.

Functionality via software

ARX Access comes with all the necessary functions to efficiently administrate access control and traffic flow, such as handling individuals, access categories, schedules, areas, etc. Additional software modules can be integrated into the system for additional functionality, for example, a booking system, elevator control, a Galaxy burglar alarm, etc. This ensures that you only pay for what you use, and still keep all doors open for future expansion when the need arises.

Wide range of compatible products

ARX Access lets entry phones, proximity readers and online cylinders communicate within the same system. The flexibility of the product makes it possible to find a solution for almost every need. It doesn't matter if the object is a single building, or a large organization spread over the entire world in offices of varying sizes.

Communication security made easy

To ensure communication security over the network, ARX Access uses PKI and SSL.

The procedure through which ARX automatically sets up a secure session between central units and the server application is new to access control systems and has been patented by ASSA.

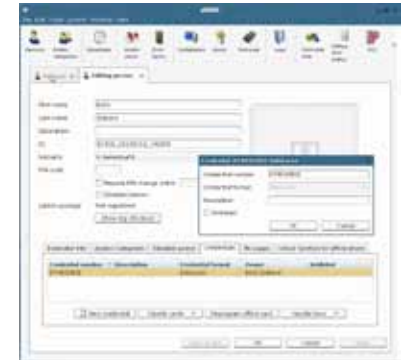

Block a lost card in a few seconds – and get results throughout the system immediately!

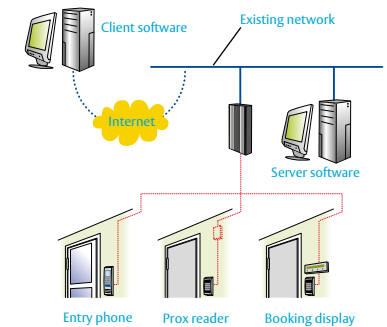

Network benefits at the installation

Since the central units are built like individual computers, communicating via TCP/IP, network benefits like DNS and DHCP can be used to do part of the setup during installation. It also means that the system backbone can use the existing network of a building for communications, which in turn means fewer cables, and this saves time and money during installation.



Introduction

Introduction



ASSA offers a complete range of lock cases that meet all requirements for security, convenience and emergency exiting. The product range includes patented hook bolt lock cases. The hook bolt interlocks the door and the frame, creating a strong unit.

Lock cases

We are proud to lead the development of lock cases that meet end users' current and future needs for security, safety and convenience.

The hook bolt in the lock case keeps the door securely locked while the latch keeps the door closed in the event fire.

The mechanical lock case is therefore a significant part of a door solution.

Our lock case series – ASSA Connect – meets all requirements for mechanical locks in residential buildings as well as the new EN standards for emergency exit devices.



A lock for every application

The ASSA Connect, a unique product from ASSA featuring many patented innovations, offers enhanced resistance to attacks and a wide range of security options.

The ASSA Connect contains over 30 different functions, including standard locking functions such as dead locking, slam locking and latching. Many buildings require special solutions for certain doors and the Connect meets these needs.

Security and safety

The lock cases are constructed to meet high-requirements by authorities regarding forced entry, fire rating and emergency escape. All lock cases are certified in accordance with EN 12209. The patented hook bolt interlocks the door and the frame, thereby creating a strong unit.

Features

All Connect locks have the same lock case dimensions. They are available in three different backsets: 35, 50 and 70 mm.

ASSA Connect lock cases with a latch and/or a cylinder latch without a hold-up function are CE-certified (1162-CPD-0233) and can be used in fire and smoke-resistant doors.



The Connect family

200 series – Latch locks

Single and double latch locks with or without various kinds of hold-up functions.

300 series – Standard sash locks

Latch and hook bolt locks with 90° key turn. Not approved (EN).

400 series – High security sash locks

Latch and hook bolt locks with 360° key turn. Approved locks.

2002 series – Special sash locks

Latch and hook bolt locks with 360° key turn. Faceplate snib deactivates internal thumbturn.

600 series – Split spindle locks

Double latch locks with or without hold-up function and latch and hook bolt locks with split function.

700 series – Emergency locks

Certified escape emergency locks in accordance with EN 179.

800 series – Electromechanical locks

Motor and solenoid locks.

900 series – Lever locks

Latch and hook bolt locks with 360° key turn.

Over 2.000 locks are installed in the Ravens Stadium in Baltimore, USA. The security management of the arena was so impressed by ASSA's products' outstanding resistance to physical attacks that it chose ASSA to be the security solution supplier.



Introduction

Introduction



ASSA offers a complete range of lock cases that meet all requirements for security, convenience and emergency exiting. The product range includes patented hook bolt lock cases. The hook bolt interlocks the door and frame, creating a strong unit.

Electromechanical locks

ASSA has been designing and manufacturing electric locks for almost 20 years. Thanks to our close relationships with system suppliers and integrators, we have a range of products that are more than components – they are part of the system. ASSA's electric locks are also part of a lock case platform. This gives you the advantage of uniform accessories and door preparations for all doors, whether mechanical or electric.



The Hansabank headquarters is the largest and most modern building in Latvia. The mechanical security and locking needs of the new building ranged from simple doors up to level 5 security. Mechanical protection combined with electromechanical functions and convenience of access control made ASSA the only security supplier that could meet the security objectives for the building. The security solution manages about 1.000 employees and 1.100 doors.

ASSA motor locks – fast and quiet

ASSA's mortise motor locks are part of the Connect lock platform, designed to meet users' requirements. The locks are fast and convenient and can be unlocked in less than half a second. They also meet the integrators' requirements, such as low power consumption and relevant I/O in the control unit.

Encrypted communication

ASSA has always been a driving force for the development of increasingly advanced security solutions. Two examples are encrypted communication and high resistance against electronic manipulation. These requirements are now part of the prEN 14846.

Solenoid handle locks with anti-panic function

ASSA has several versions of the Connect-based solenoid handle lock. One unique feature is the optional deadbolt. This offers a convenient privacy mode for several applications.

All locks in the product range are multifunctional, with interchangeable handing and multivoltage. This reduces stock in the distribution and allows installers to manage most installations without ordering special parts.

Electric strike plates that manage millions of openings

ASSA offers a wide range of ASSA ABLOY Group products. One example is electric strike plates. They are designed and refined to fit with ASSA's lock case ranges, Connect and modular.

They are all produced by top-notch suppliers in their field.



Door hardware

We believe that you, the customer, should have a choice in how you want to design your door environment. Naturally, the security aspect is also of utmost importance when it comes to door hardware, which is why we have an extensive range of decorative accessories, all developed to suit your needs.



A product range that covers all bases

A lock unit contains a cylinder, a lock case and security accessories. The door construction demands compatibility between the three parts.

ASSA offers door hardware for nearly every door and window on the market. From decorative handles in a range of matching finishes for interior doors to sophisticated emergency exit accessories to glass partitions in public buildings. We make it possible to create a consistent design throughout your building. Functionality and design in every detail – ASSA develops products that give added functionality in their normal environment. Handles with integrated locks, thumbturns and handles with useful features for the disabled and nickel-free finishes, greatly reducing the risk of allergic reactions.

Tested for all demands

All of our high-security products are developed and tested by independent test labs to conform to European standards and regulations, meeting and often exceeding the highest security demands in the market.

Designing good security

With the primary goal achieved – a sufficient level of door security – the next step is to evaluate and determine what kind of design you are looking for. Lever handles, pull handles, decorative long plates, cylinder rings and door stops are just some of the products

Handles that match every door and window, and, equally importantly, the architecture of the building.



that can be combined to create an aesthetically pleasing security solution.

There are many aspects to consider when choosing the architectural hardware for your door environment. With ASSA you have choices, and we are more than willing to help you make a decision.



The Estonian National Opera is one of the most important buildings in Estonia in terms of the country's cultural and musical heritage. ASSA was chosen as the supplier of the new security solution in 2005 because of the high quality of its products, and because ASSA offers products whose design harmonizes with the building's historical interior.

Because of their discreet design and durability, ASSA Handles were ideal for the 142 doors in the majestic theatre hall, blue hall and rooms for the audience.



Door control

ASSA door closers comprise a range of products that are ideal for safe and secure closing of doors in public, institutional or commercial buildings.

We in the ASSA ABLOY Group have more than 80 years of experience of door control.

Our products open and close doors in all parts of the world. We provide a wide variety of door control solutions that do a lot more than just control the door.

Frequently, door automation is the best alternative for opening and closing doors in public environments, as it enhances the independence of people with reduced mobility.



Convenience and safety in one package

When you have ASSA door closers, you don't have to compromise. We combine the sense of free mobility with reliable door closing. The doors open in a controlled way and close quickly but silently. We meet today's stringent requirements with reliable door closers that are discreet and elegant.

ASSA's door closer manufacturing system is flexible enough to meet the requirements for OEM applications. The range includes models for the KONE and OTIS elevator companies and is further supplemented by special models, which can be mounted inside the door leaf or door frame. Our quality system is ISO 9001-compliant and our products meet the requirements of national standards such as EN and ANSI.

Automatic opening for optimum service

ASSA offers automatic door openers for maximum convenience. Many facilities, such as hospitals, warehouses, transportation industry facilities and retirement homes, depend on their access paths and doors being remote-controllable. Our automatic door openers fit all types of doors, from light, thin interior doors to large, heavy glass and steel partitions. Silent and reliable operation is the hallmark of ASSA's automatic door openers. You can decide how long the door will remain open, and how rapidly it will open/close.





ASSA's emergency escape range consists of two different types fittings: panic devices and emergency escape fittings, both created for public areas. The panic device must allow the door to open with one push, for example when people are pressed against the door.

Emergency exit hardware

ASSA has vast expertise in the area of panic and emergency exit hardware and its application in many countries throughout the world. Our goal is to share this expertise with you so you can navigate the complex rules and regulations surrounding this critically important subject.



Our product range follows standards – all over the world

ASSA can provide you with CE-labeled exit hardware that meets the requirements of EN 1125 and EN 179 – and still keeps your building secured from unwanted visitors!

A building lost to fire can always be replaced. Human life lost to fire cannot. But you can help make a difference with the systems and products you choose. In building fires, it is important to have an adequate number of exit doors that swing outwards and that can be easily operated without having prior knowledge of how they work.

Security and safety do not need to be mutually exclusive. You do not have to sacrifice security (resistance to forced entry) to achieve safety for people who need to escape from an emergency or life-threatening situation.

ASSA exit system solutions can provide ease of escape from a secure building.

Panic bars provide an exit in seconds

A horizontally mounted bar across the inside face of the door is called a panic bar. It is intended for use in facilities with a large number of people and where panic situations may arise. A panic bar provides a safe and effective escape through a doorway with minimum effort and without needing prior knowledge of the panic exit device.

Escape possible through every door

ASSA also offers panic emergency locks with handles intended for emergency purposes where panic situations are not likely to arise. They are designed to provide safe and effective escape through a doorway with one single action to release the device.

The security equipment for each and every door including door signage, operation and operational reliability, is subject to strict requirements in places where many people gather in a relatively small area.





We work closely with our customers to find customized solutions, because cam locks are often used as components in other products.

Industrial locks

ASSA makes a wide range of cam locks, varying in size and shape to cover a complete range of uses: domestic, leisure and industrial – from lockers, cabinets and desks to gas pumps, parking meters, gaming machines and downhill skis.



Reliable locks for every use but a normal door

Our cam locks are designed and tested for optimal performance in every aspect. They are extremely strong, made of nickel-plated solid brass with thick steel catches.

Same key for the entire building

We work closely with our customers to create customized solutions because cam locks are often used as components in other products. An ASSA Cam lock is a cylinder in various security ranges intended for installation in cabinet doors, which can be implemented in a Master Key System in combination with other cylinder shapes.

Most ASSA cam locks require the same door preparation, which is also an advantage in smaller production runs.

Coin locks for temporary secure storage

ASSA coin locks are extremely cost-effective and are the perfect solution where temporary secure storage is required. The key is captive until the correct coin or token is inserted. When the door is later opened with a key, the coin/token passes through into the return tray or collection box. The key is then captured again and the locker is available for immediate re-use.

ASSA coin locks fitted with removable cylinders are ideally suited for applications where a need may arise for cylinders to be changed quickly to ensure that lost or stolen keys will not compromise security.

Fits coins all over the world

Cylinders may be removed/exchanged using a special management key to ensure that stolen keys cannot be used to personalize or re-visit a locker. ASSA coin locks are available for all types of currencies. Locks can be manufactured specially for customer-specified tokens.





Electronic key management

Many companies and institutions manage keys on a daily basis. One might think that only organizations with many keys and users need an electronic key management system; but small organizations with only a few keys will also benefit from an electronic key management system. One single key can signify very high value and generate important confidence among customers and other interested parties.



Access to the keys only when needed

An electronic key management system monitors the keys 24 hours a day, throughout the year. Users are responsible for the keys only when they have removed them from the cabinet, which increases the likelihood of their being returned.

User-friendly graphic user interface

A high degree of security and user friendliness characterize our products. They are used in industries such as healthcare, security, education, government, real estate, correctional facilities and logistics.

Use can be monitored and regulated by simple, user-friendly software, and a customized use history can be generated and printed. All this assures full control of key management.

The system from ASSA Key Solutions comes in a variety of sizes and combinations that suit most needs and preferences. ASSA Key Solutions supplies systems that can manage everything from a few keys to thousands of key groups.

Enterprises in which separate lock systems are managed centrally may require secure key storage capability. ASSA Key Solutions gives you total oversight of who had which keys when.





Approved, individually certified or product certified

Lock units meeting class 3 or higher according to SS 3522 are called "approved lock units" in the industry. This refers to what was previously a set performance level defined by the Swedish Insurance Federation, but has become a general concept on the market as a level of quality for break-in protective properties in the complete lock unit and its components. A certificate issued by an approved notified body indicates that the product meets applicable requirements.

So what is the difference between individually certified and product certified?

Individual certification is a simpler form of certification and verifies that the tested object (or service) meets the set requirements. It is initiated by an application from the manufacturer, based on the manufacturer's documentation, including a test report from an accredited testing laboratory. A product certificate verifies that the tested object (or service), and all products of the same type as the tested object, meet the set requirements. It is initiated by an application from the manufacturer, based on technical documentation, a test report from an accredited test laboratory, the manufacturer's quality system and annual reviews of production conducted by the issuer of the certificate.

Approved lock units

One requirement for approved lock units has been that the products meet set requirements defined by the applicable Swedish product standard. Swedish standard SS 3522 defines classifications of break-in protective lock units. A lock unit consists of a lock cylinder, lock case, strike plate, and where applicable, reinforcements. The standard defines five classes of which the two lowest (class 1 and 2) prioritize ease of evacuation over break-in protection, and therefore do not meet the requirements for an approved lock unit. Each class refers to product standards in which requirements and testing methods for the product have been defined. Before classification, the products are tested by the Swedish Theft Prevention Association to ensure that they meet the requirements. The test report from the Theft Prevention Association formed the basis of the individual certificate or product certificate. The Swedish organization for fire and safety certification (SBSC) and Det Norske Veritas (DNV) are some of the companies that issue individual certificates and product certificates.

Certifying/testing companies

The Swedish Board for Accreditation and Conformity Assessment, SWEDAC, has accredited SBSC to certify products, quality systems and personnel. Individual certificates and product certificates are issued by the Swedish Theft Prevention Association and the Swedish Fire Protection Association. Det Norske Veritas, DNV, is accredited by SWEDAC to certify products and quality systems. They issue certificates for construction fittings, including products such as emergency door fittings and door closers. CITAK issues certificates for fire safety classification.

CE labeling

All products affected by an EU directive must have CE labeling. The construction products directive, CPD, is the main one that applies to door hardware, but others also apply, such as the electromagnetic compatibility directive, EMC, and the low-voltage directive, LVD. All of these directives may require CE labeling of construction products. Under CPD, door hardware must meet requirements in connection with fire and evacuation. The requirements for each product are described in Annex ZA in the product's classification standard. Before the CE label may be put on the product, the following procedure must be completed:

- a) Testing by an accredited testing laboratory.
- b) Certificate issued by an approved notified body.
- c) A manufacturer's declaration that the product meets the set requirements.
- d) CE labeling on the product, packaging and instructions.

At the time of publication of this catalog, point d) is optional in Sweden.



Fire safety classification

Fire safety classification of door hardware is always based on testing on a door. Certificates for individual products are always linked to the door on which they were tested. Revision and adaptation to European standards for fire door classification is underway (2004). To use the product in fire doors of different types and materials, and individual assessment must be done in each case.

Evacuation

The function and performance of emergency door fittings is specified in SS-EN 1125 or SS-EN 179. Fittings for doors in various evacuation pathways are described in the brochure "Emergency and evacuation door fittings, European guideline 2002:2", issued by the Swedish Fire Protection Association. All emergency door fittings intended for fire-class doors must meet the requirements for CE labeling (even if CE labeling on the product is not currently mandatory in Sweden).

Standards

Swedish standards are published by the Swedish Standard Institute, SIS. The institute establishes technical committees with members from various stakeholders, such as the door hardware industry, and part of its task is to adapt Swedish standards to the new European standard. Over the past few years some 15 new European product standards have been published as Swedish standards as well, solely in the field of locks and fittings. Another 10 are expected to be published soon.

ASSA Testing Laboratory

The ASSA Testing Laboratory (ATL) is a testing laboratory for products in locks and fittings. Since 1998, part of its operations are accredited by SWEDAC. The accreditation means that ATL works as an independent testing laboratory for verification tests, and includes testing the break-in safety of lock units, testing of cylinders, lock housings, emergency door fittings, door closers, door hardware, strike plates and hinges according to the Swedish and European standards. ATL staff participates actively in the work of developing Swedish and European standards for products in locks and fittings. In addition to accredited testing, ATL conducts several standardized tests on products in locks and fittings with documented verifying methods, which follow the same principles as accredited tests.



Maintenance ensures proper function

Many factors affect the opening and closing of a door. Your door needs regular service and preventive maintenance to ensure its proper function. The lock unit is subject to various stresses. In no time at all, the door has been opened and closed tens of thousands of times. Often carelessly, especially in workplaces and public environments.

ASSA Licensed Service Stations

ASSA recommends property owners/managers to establish a service and maintenance agreement for the lock system with an ASSA Licensed Service Station. If you would like to know more, visit our website, www.assa.se, for information on local assistance and service.

Security Center

Have your selected service station conduct a complete functional test annually, focusing on wear, lubrication, wires, contacts and key performance.

For service and maintenance of electronic products, we recommend a specially authorized Security Center. The Swedish Theft Prevention Association issues special authorization for the design, documentation, installation and startup of approved electromechanical lock systems.

For additions and expansions of lock systems

When expanding a lock system, we recommend the system owner not to include lock cylinders, keys or access control systems in the building contractor's commitment. This is so that the system manager, along with the ASSA Licensed Service Station, will always have full control over the lock and access control system.

Mechanical lock cases

We recommend lubrication with oil twice a year. Make sure to lubricate both sides of the latch bolt. Use oil with good adhesion, such as ASSA lock oil.

Warning!

Tumbler locks must never be lubricated internally.

Electric locks

Treat the mechanical parts as defined above. Inspect the wiring, wire transfer and contacts. Clean oxidized contact surfaces and replace wires when damaged. A total functional inspection should be conducted annually by your selected service station. If you have electric strike plates, check that they are receiving the correct voltage and that all indicators work properly.

Warning!

Never lubricate the inner parts of the lock housings with lock spray. File and emery shavings will disrupt the lock's function. Flawed installation may reduce durability and impair function.

The lock unit

When annually testing the function of the locks, also check the tightness of screws for lock housings, fittings, door handles and strike plates.

Strike plates

For smooth, even function, the sliding surface between the latch bolt and the strike plate should be lubricated at least twice a year. Use ASSA lock oil, wiping away any excess. Secure closure is also important for fire safety, to keep fires from spreading. Regularly check the condition of weatherstripping and the gap between the strike plate and the latch bolt in the lock housing. Adjust where necessary. If you have electric strike plates, check that they are receiving the correct voltage and that all indicators work properly.

Warning!

File and emery shavings will disrupt the lock's function. Flawed installation may reduce durability and impair function.

Door handles

When annually testing the function of the locks, also check the tightness of screws on the door handles. Fittings may oxidize in aggressive environments. Where necessary, the oxidation can be removed with a suitable polish.



Fittings

When annually testing the function of the locks, also check the tightness of screws on the door reinforcements and cylinder fittings. Fittings may oxidize in aggressive environments. Where necessary, the oxidation can be removed with a suitable polish.

Controlling unit

Where applicable, regularly check the battery backup. This is an absolute must for the function of emergency doors. At least once a year, have your selected service station conduct a complete functional test. Inspect the wiring and contacts. Clean oxidized surfaces and replace wires when damaged. Ensure that the controlling unit receives the correct voltage.

There may be many reasons that a door does not close properly. The picture on the next page shows most components that affect the opening and closing of a door. This means that it is usually not easy to troubleshoot. For example, increasing the power of the door closer to force the door shut is not a good solution if the lock mechanism is worn or unlocked, or if the door is crooked. For this reason, it is very important that the service staff is aware of the factors affecting the function of the door, to ensure that they inspect and adjust it according to the service instructions.

Door closers

To enhance the lifespan of a door closer and maintain its preset functions, check twice a year that all mounting screws are tightened. When doing this, also snap open the door arm and oil the joint.

Automatic doors

ASSA automatic doors should have regular service once a year. If they open and close extremely frequently, service the doors at least twice a year.

The gear drives of automatic doors should be oiled regularly to ensure the lifespan of the motor. Automatic doors DA835 and DA836/7002, which have micro breakers that control opening and closing, also need to be inspected to ensure that they are well anchored in their holders. Automatic doors DA835, DA400/7001 and DA836/7002, which have the motor hung on a rubber suspension, should be inspected to ensure that the rubber attachments are whole. Automatic door DA7501, which has spring tension, should be inspected to ensure that the spring works properly. To enhance the lifespan of an automatic door and maintain its preset functions, check twice a year that all mounting screws are tightened in the motor housing and the arm attachment.

Emergency door fittings

At least once a month, make sure that all screws are tightened and that the opening mechanism moves smoothly. Open the door by pressing on the opening mechanism of the emergency door fittings.

Make sure that the latch bolt goes fully into the strike plate when the door closes. When this happens, the emergency door fittings should snap back to the original position. If an exterior door handle is installed, also check the ability to open the door from the outside. Make sure the detail on the emergency exit door is unharmed and clearly visible.



Lock cylinders

Clean and lubricate lock cylinders at least twice a year. Use ASSA Lock Spray. If the lock is used extremely frequently, for example in a garage, or in extreme weather conditions, we recommend more frequent cleaning and lubrication. To prevent functional failures due to condensation or freezing, we recommend cleaning and lubricating just before the winter season.

Warning!

Never use oil or graphite in lock cylinders. Oil will cause the lock to stop working. If your lock cylinders repeatedly jam, contact your selected service station for service and repairs.

Note that keys normally wear out and should be replaced when they are no longer reliable.

ASSA Lock Spray

A lubricant that significantly increases the lock's reliability and lifespan.

- Clean first with ASSA Lock Spray if the lock develops ice or dirt inside
- Effective – small amounts give quick results. Quick drying – does not attract dust or grime.

Hinges

The need for service and maintenance depends on the frequency of opening, the weight on the hinge and the environment.

At least once a year, check: function, need for lubrication, and any loose screws. See the maintenance section in the chapter on hinges.

Warning!

Loose hinges make the door swing crookedly, increase wear and make it easier to break in.

Screws in newly installed doors must always be tightened afterwards, when the wood in the door frame and door has dried. As hinges begin to wear, a fine black dust builds up around the turning point. It often gets on the door frame and the door/window/cupboard door. The best way to avoid this is to keep the hinges well lubricated. If you raise a door by putting a spacer on the hinge pin, this causes additional wear and poorer function.

There may be many reasons that a door does not close properly. The image below shows most of the components that affect the opening and closing of the door.

This means that it is usually not easy to troubleshoot. For example, increasing the power of the door closer to force the door shut is not a good solution if the lock mechanism is worn or if the door is crooked. For this reason, it is very important that the service staff are aware of the factors affecting the function of the door, to ensure that they inspect and adjust it professionally.

OPENING/CLOSING

Frequency and precision of inspections

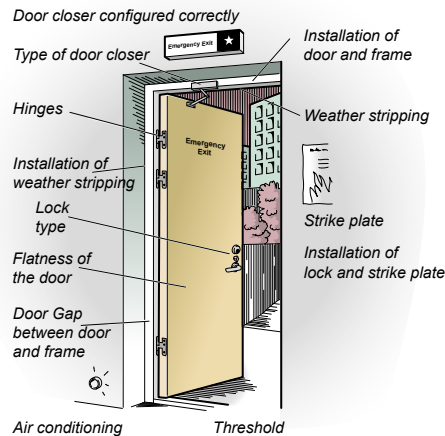

ASSA Testing Laboratory

The ASSA Testing Laboratory (ATL) is a testing laboratory for products in locks and fittings. Since 1998 part of its operations are accredited by SWEDAC. The accreditation means that ATL works as an independent testing laboratory for verification tests, and includes testing the break-in safety lock units, testing of cylinders, lock cases, evacuation equipment, door closers, fittings, strike plates and hinges according to the Swedish and European standards. ATL staff actively participate in the work of developing Swedish and European standards for products in locks and fittings.

In addition to accredited testing, ATL conducts several standardized tests on products in locks and fittings with documented verifying methods, which follow the same principles as accredited tests.





MASTER KEY SYSTEMS

With patented products that complement each other, we are ready to meet the needs and security demands of our customers and markets.

ASSA cylinder platforms provide key control for all levels of security and create a flexible foundation for planning a Master key system.

All our mechanical high-security cylinders with dp technology can be combined in advanced on line and off line solutions, such as CLIQ, dp Tronic and proximity technology.

The foundation of a security solution is having different security zones and complementing the mechanical authorization of the key with electronics for intelligent on line and off line functions.



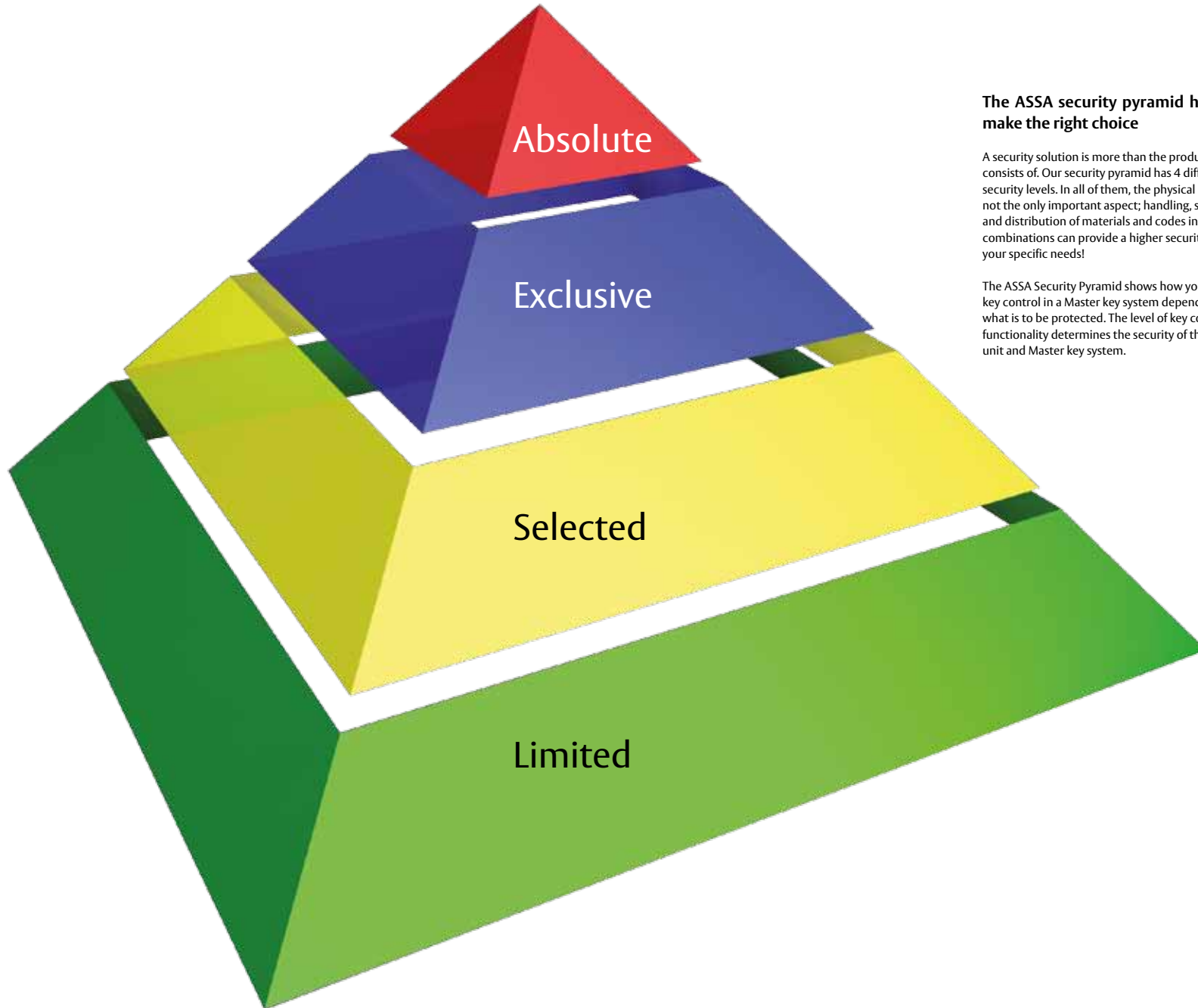

The ASSA security pyramid helps you make the right choice

A security solution is more than the products it consists of. Our security pyramid has 4 different security levels. In all of them, the physical product not the only important aspect; handling, services and distribution of materials and codes in various combinations can provide a higher security based on your specific needs!

The ASSA Security Pyramid shows how you can adjust key control in a Master key system depending on what is to be protected. The level of key control and functionality determines the security of the locking unit and Master key system.

Absolute

The Absolute security level offers key control in which there is always a registered authorization contract between the system owner and a selected and certified ASSA Service Station. These contracts regulate responsibility for additions and service as well as re-orders of keys made from patented and design-registered key blanks. The keys can be authorized and audit trailed on line or off line, depending on technology.

Exclusive

The Exclusive offers key control in which extra keys are made out of patented and design-registered key blanks. An approved and registered authorization contract is needed when reordering keys. The keys can be authorized and audit trailed off line.

Selected

The Selected offers key control in which extra keys are made out of patented and design-registered key blanks. An approved and registered authorization contract is needed when reordering keys. Master key systems can be specified with a combination of two different levels of security, high and medium. Mechanical cylinders are recommended for Master key systems such a system is sufficient to meet the needs of security and convenience.

Limited

The Limited security level offers key control in which keys can be copied at a certified ASSA Service Station provided that the customer has a test key and valid identification. The limited level is recommended when there is no demand for patented key control.

Master key systems

Master key systems



Commercial premises

Offices, industrial premises and shops can be made up of various properties or departments with different activities and purposes, which in many cases are physically separated from each other. ASSA offers a modern security solution that is designed to give full flexibility and security through a combination of online and offline products. The benefits of this security system include user friendliness, clever design and low overall cost.

You will doubtless be familiar with the amount of administration that is involved in issuing keys to employees, temporary staff and contractors. A key that is out of your control immediately poses a risk to the security of your staff and your business, and can mean unforeseen costs for safeguarding perimeter protection. The amount of work involved in making the changes necessary to maintain a high level of security is often excessive and time-consuming. As a result your company's security may be eroded.

Public premises

If you are responsible for security in the public sector, you will already understand that changes in operations frequently also result in the movement of staff. By definition, public premises will not only be used by authorized personnel. The usual way of meeting such demands for flexibility and security is to issue staff with several different keys.

A single key that is out of your control immediately poses a risk to the security and the convenience of staff and other users, as well as increasing the risk of break-ins and vandalism, which can be very costly. It is often considered too expensive or time-consuming to make the changes that would be needed to retain the original high level of security. This inevitably leads to the security of the business becoming compromised.

Housing

As a system manager of an apartment building or complex, you are undoubtedly familiar with the need to issue keys to new tenants and contractors on a daily basis. It is not unusual for a key that has been issued to be used by several different people. A tenant may lend a key to relatives or friends, or a key that you have issued may be used by a number of people during servicing or repair work. When an issued key is not returned for some reason, problems may arise, such as vandalism, break-ins into basement or attic stores, or unauthorised access to the property. With a traditional lock system, it generally takes a lot of time and effort to ensure that a lost key cannot be used to gain access.

This is why ASSA developed its intelligent lock systems with dp-tronic and/or CLIQ™ technology. We began with our proven and renowned ASSA dp mechanical lock platform and integrated electronics into the cylinder and keys. You will already be familiar with the level of mechanical performance and security in our existing range, but the addition of electronic control opens up a new dimension and lets you change access for users or block lost keys. Once you have made this change you can relax and decide what further action should be taken at your leisure.

On line solutions with dp-tronic allow system managers to make changes over a network and provide a complete overview of events and times for scheduled activities and emergency action.

Off line-solutions are based on lock cylinders with CLIQ™ technology that do not require additional wiring for individual electronic programming. This technology permits changes in access to be made at the group and/or individual level by adjusting the mechanical configuration of the locks.

We recommend a combination of online and offline technology for both large and small installations. This provides a flexible platform that can accommodate future changes in activities while maintaining a high level of security.



Security requirements vary enormously between industrial plants depending on their size and type of business. One requirement they all have in common is for a well-integrated locking system.

Zone division

The way a company is organized, the plant layout, the number of manufacturing units and the focus of production all determine how the premises should be divided into security zones. Typical zones can include the R&D department, utility areas that house control and regulation equipment, warehouses and the IT department.

Access levels

Lock system security is ensured by the mechanical configuration and appropriate categories for keys. Each category may consist of one or more electronic groups depending on how the company is organized and the security requirements that apply. This allows access levels to be created electronically for staff such as caretakers, contractors and service companies that only require limited access to the premises.

Application

Depending on the choice of electromechanical features it is possible to provide timer control and logging features for changing lockers, padlocks, etc.

Benefits

- Flexibility
- Many different applications
- Varying authorization levels
- Low overall cost

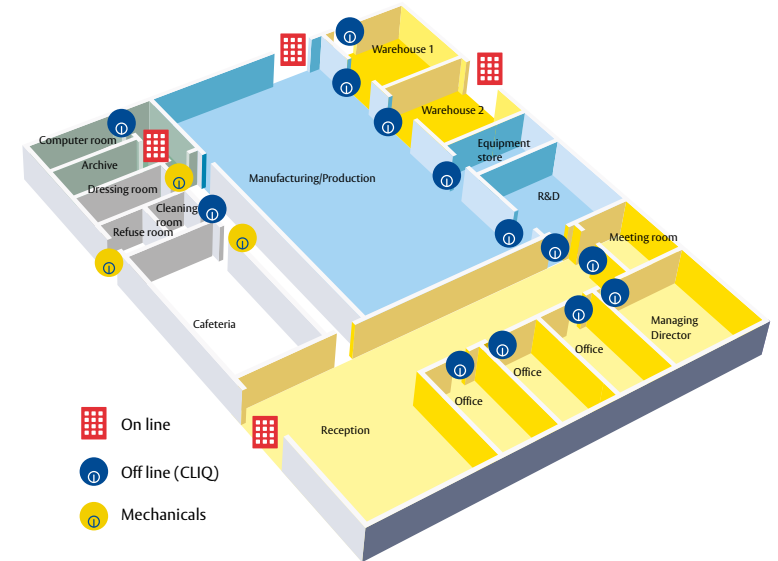

Perimeter protection, with the exception of emergency doors, is equipped with online control. Doors within the perimeter that require higher security and event logging are equipped with offline control, with the exception of the document archives, where online control is recommended for logging the time of events.

On line control is recommended for areas where it is necessary to change access authorization frequently, or to log the date and location of events.

Off line control is recommended for areas where security, flexibility and event logging are especially important.

Mechanical cylinders with dp technology are used for doors where the mechanical construction of the lock system is sufficient for the operational needs.



In hospitals, the need for openness and easy access has to be balanced against the need to keep staff and patients safe and to protect medicines and equipment. This makes it extra tricky to plan access control to such premises. This applies equally to external perimeter protection and the prevention of unauthorised access to inner parts of the hospital.

Zone division

The hospital wards and clinics form the central core of security zones within the premises. They are divided into zones using mechanical combinations. Typical zones can include the reception desk, surgical wards or recovery wards in each unit. Utility areas form another important security zone.

Access levels

Electromechanical control is used to divide the security zones electronically into one or more access groups for each unit. Individual access can be programmed for selected areas such as research, drug storage and document archives.

Application

Depending on the choice of electromechanical features, you can select timer control and logging features for medical cabinets, security boxes, padlocks, etc.

Benefits

- Flexibility
- Many different applications
- Varying authorization levels
- Low overall cost

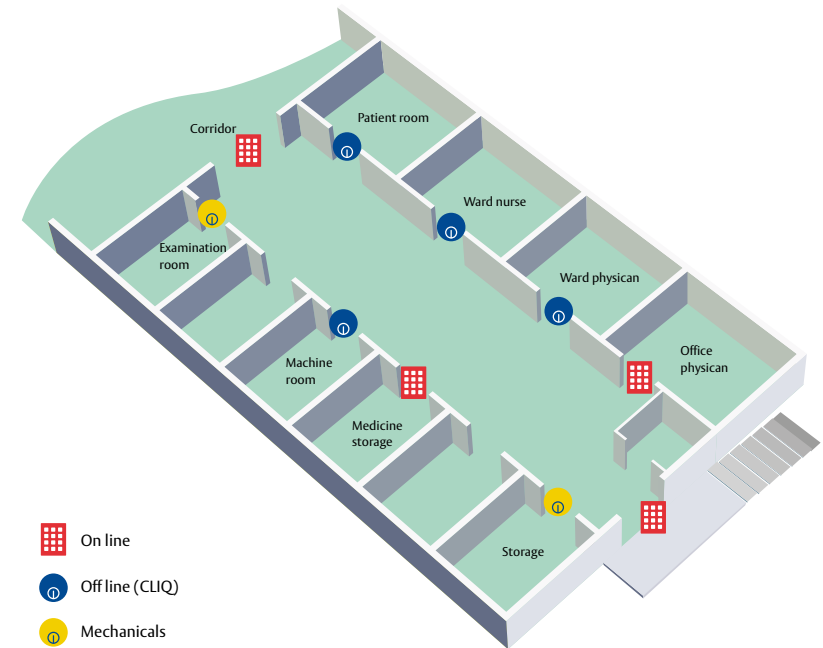

- On line
- Off line (CLIQ)
- Mechanicals

On line control is recommended for areas where it is necessary to change access authorization frequently, or to log the date and location of events.

Off line control is recommended for areas where security, flexibility and event logging are especially important.

Mechanical cylinders with dp technology are used for doors where the mechanical construction of the lock system is sufficient for the operational needs.



Because school premises are often in use from early morning to late evening, the level of security must be adapted to suit various activities. This applies to all types of school buildings, large and small, for pupils of all ages. Colleges and universities have an even greater need for flexibility and security, since staff, lecturers, students and others may be present in the premises around the clock.

Zone division

Ordinary school activities, after-school clubs and the use of premises by various associations in the evenings and on weekends can be combined in appropriate security zones. Special access levels can be created for caretakers, contractors, service companies and the like who need limited access to the premises.



Access levels

The security zones are divided mechanically into access groups for each unit. Access can then be programmed electronically at group/individual level.

Application

Depending on the choice of electromechanical features, you can select timer control, logging features for padlocks, etc.

Benefits

- Flexibility
- Many different applications
- Varying authorization levels
- Low overall cost

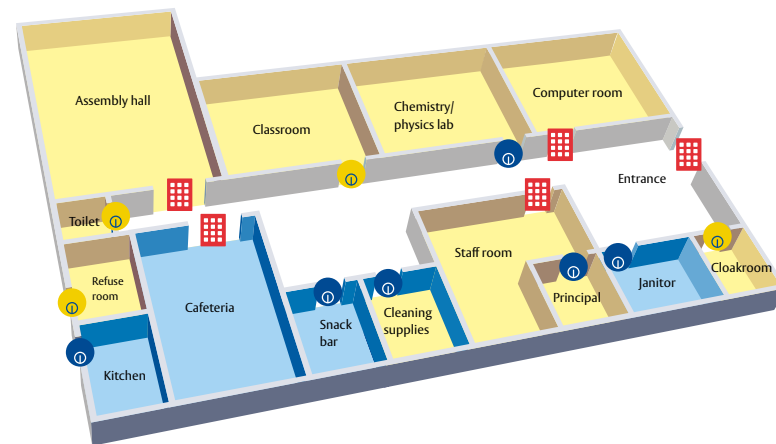

- On line
- Off line (CLIQ)
- Mechanical

On line control is recommended for areas where it is necessary to change access authorization frequently, or to log the date and location of events.

Off line control is recommended for areas where security, flexibility and event logging are especially important.

Mechanical cylinders with dp technology are used for doors where the mechanical construction of the lock system is sufficient for the operational needs.



Apartment buildings and other types of collective housing that have shared utility and storage spaces generally have similar security requirements.

Zone division

Suitable zones may consist of the individual apartments and areas set apart as basements, attics, recycling areas, laundry rooms, garages, storage for bicycles and strollers, as well as utility areas.

Access levels

Access to common areas is controlled by electromechanical operation. Access to desired areas such as garages, bike storage, etc., is controlled at the group/individual level.

Application

Depending on the choice of electromechanical features, you can select logging features for padlocks fitted to access booms, etc.

Benefits

- Security
- Improved control over keys, reduced vandalism
- Flexibility

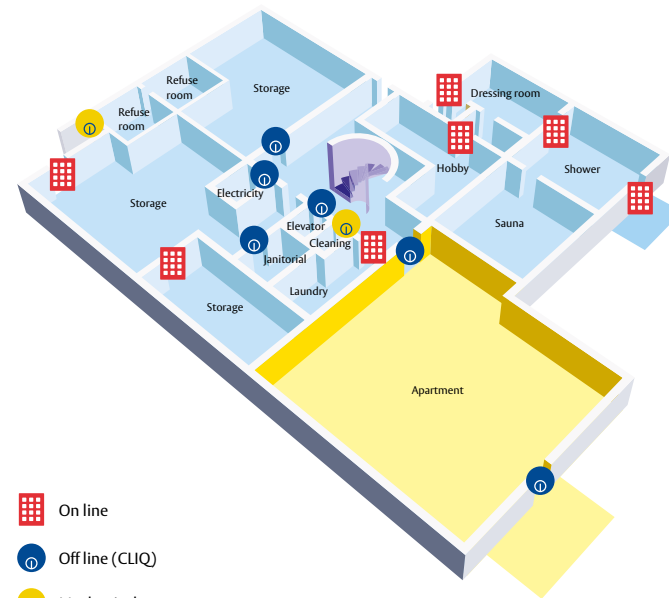

On line control is recommended for areas where it is necessary to change access authorization frequently, or to log the date and location of events.

Off line control is recommended for areas where security, flexibility and event logging are especially important.

Mechanical cylinders with dp technology are used for doors where the mechanical construction of the lock system is sufficient for the operational needs.

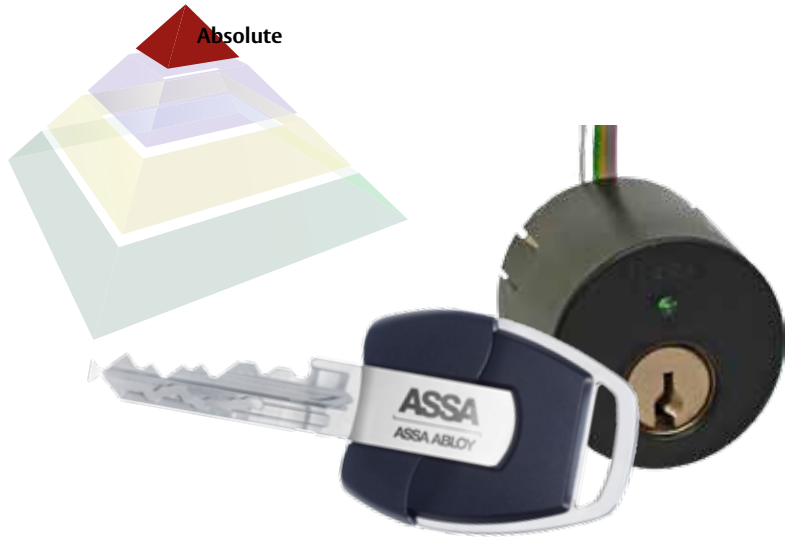

Application

The ASSA dp Tronic is used as effective online perimeter protection, and for doors demanding registered, controlled security. The ASSA dp Tronic is included in high-security locksets and has the same possibilities and conveniences as ASSA Access Control Systems.

The system is easy to connect to doors requiring effective online security. The dp Tronic consist of a high-security cylinder combined with electro-mechanical blocking. The key consists of a patented mechanical code and a unique electronic system code. The dp Tronic key communicates with the cylinder through the antenna to secure authorization and the event is registered in the system's local central unit.

Integration in Master key systems

A Master key system with ASSA dp technology makes it possible to integrate dp Tronic in one or more doors without changing the rest of the Master key system.

Access Control System

With the ARX Access software, the administrator can manage the access control system effectively and rationally.

Characteristics

Fundamental mechanical security. The cylinder contains electromechanical and mechanical codes for blocking. The LED glows green light when access is granted. If the key is unauthorized the LED indicates glows red. The antenna is integrated in a decorative casing surrounding the cylinder and should be fitted with cylinder accessories for additional protection.

Designed for the Scandinavian round or oval cylinder, with single or double cylinder models.

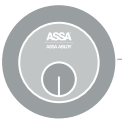

Nomenclature and system architecture

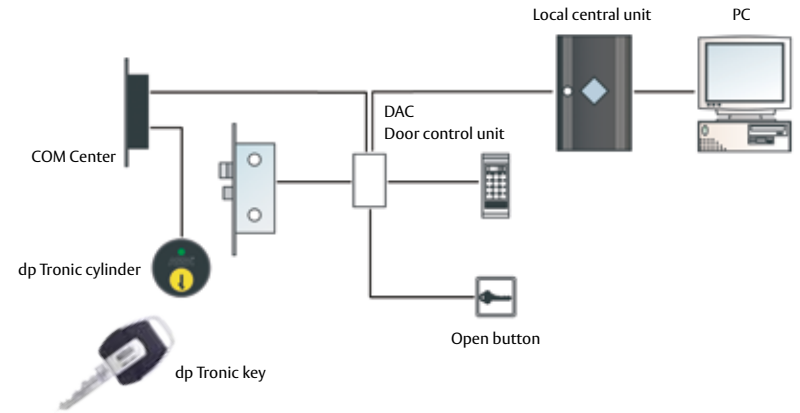

PC software

- ARX access control system

Data

- Power supply via DAC: 17 – 24 VAC / VDC +10% or 12 VDC stabilized
- Power consumption: max 0,4 A

Environment

Key, cylinder, COM center and reader:

- Temperature range -30 °C – +70 °C

Local central unit:

- Temperature range 0° C – + 65 °C.
- 20–90 % relative humidity, non condensing

Local central unit range

- LCU 9016
- LCU 9017
- LCU 6516

Cylinder range

ASSA 4400 dp series



Administration

CLIQ cylinders and CLIQ keys are programmed using the CLIQ Web Manager software. The system can be administered by one or more users simultaneously and provides a good overview of the locking system, authorizations and issued keys. CLIQ Web manager does not require local installation on a computer. The program is web-based, which ensures that the administrator always works in the latest version, as well as automatic backup of the database.

No additional software has to be installed, nor does any server space have to be allocated at each company that uses CLIQ Remote.

Updating

Administrators can make all daily changes without ever needing to have the keys physically. Instead, the respective key holders find a key updater and download their new authorizations. The key updater can be conveniently located at a staff entrance, service office or other location that personnel pass, so that everyone can conveniently update their keys.

With a CLIQ Remote system changes can easily be made without replacing or collecting keys or cylinders. Even if cylinders should still have to be moved, this is easily done since no cables are connected.

Traceability

All keys are unique. As a precaution, it may be good to know that each time a key is used it is recorded and the information is stored in the cylinder and the relevant key. The key carries information about the doors it has unlocked. Keys that try to unlock doors for which do not have authorization are also registered.

If an incident should occur, an investigation may require tracking which keys have passed through the doors by checking the log list, since all data are stored in the CLIQ Web Manager. Of course, only authorized system administrators may have access to the logged events.

Validation

Unfortunately, sometimes keys disappear, are temporarily lost or not returned. But, since the CLIQ key has a battery with built-in clock, this problem can be solved by implementing validation requirements.

For example, if keys are programmed with authorization for 24 hours, the user must access a key updater in order to get new authorization afterwards. Such a solution is ideal for cases such as a service technician with a short assignment, or someone who needs access and authorization during a particular shift. A lost key to an important door is therefore no longer a security risk. The electronic authorization can simply be blocked, and the key becomes useless, even if it fits mechanically. And of course if the key is found at a later date, it can be updated and used again.



CLIQ Remote means that:

- 1 **A key with CLIQ™ has a built-in clock and memory**
 - Makes it easy for the administrator to control authorizations with the schedule.
 - A key with CLIQ can be controlled to work at different times on different days.
 - A key with CLIQ can be issued before the time when it will work.
 - A key that is not returned will stop working at a specified time.
- 2 **Validation of keys increases security if a key is lost**
 - With validation users extend their authorizations to relevant doors.
 - New authorizations are automatically loaded into the key when the key is updated.
 - Regular validation significantly reduces the risk of lost keys.
- 3 **Traceability and logs create safety for all users and administrators**
 - Every time a door is unlocked, or an attempt is made to do so, it is logged in the system.
 - If necessary, the administrator can view all events in CLIQ Web Manager.
- 4 **Remote updating of authorizations minimizes work and saves time**
 - No keys or cylinders need to be collected to make changes to authorizations.
 - All administration of authorizations can be done via web-based software.
 - The key updater is connected to the network and can be positioned according to the customer's wishes.
- 5 **The combination of mechanics and electronics provides a unique level of security**
 - A patented mechanical key is the cornerstone of all security. Electronics further strengthen it over time.
 - The option to combine cylinders with CLIQ for high security with only mechanical cylinders creates cost-effective solutions.

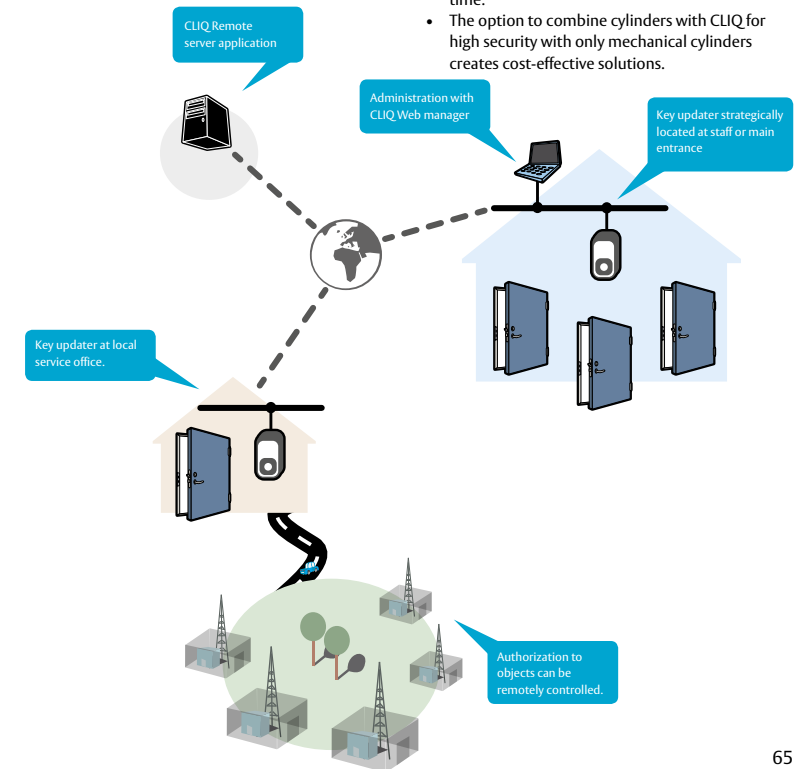

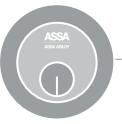

UKT User key
CLIQ Remote makes intelligent, flexible and high security lock systems possible. The key's mechanical design creates the basic foundation made up of different security zones in the same way as in mechanical lock systems. The electronic programming of the keys gives authorization to individuals or to a group of individuals.

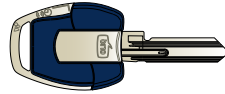

CK Programming key
The system operator's key. It is used to activate and deactivate keys for specific cylinders. It can carry information to adapt authorization and/or read the cylinder history. Cylinder programming is not possible without the object's Set-Up key.

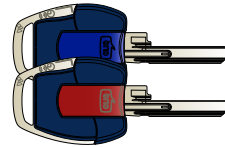

PDK Contact key
The system operator's key. The contact key is used to identify cylinders and when expanding the lock system.

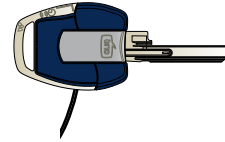

DK Service key
The service station's key. It is used for identification between ASSA and the service station, in digital communication and as complement to CLIQ keys and cylinders.

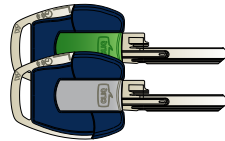

Wall PD
A Wall PD unit is used in a CLIQ Remote system to allow the user to update their key permissions, without visiting the administrator.



Cylinders
Delivered in round and oval format or various types of padlocks. The cylinder is certified by SBSC AB and meets the requirements for S53522, class 3. SSEN 1303 Grade 6.



Power supply
Lithium battery of standard 2025 type.



Terminal
Programming unit for programming and activating cylinders and keys with CLIQ function.





ASSA dp CLIQ



Application

ASSA CLIQ technology offers effective off line perimeter protection, and can be used for doors that require registered and controlled security. The technology provides electronic authorization on the group or individual levels. Master key cylinders with CLIQ function has the same security grade as mechanical ASSA dp cylinders but feature advanced electronic flexibility and security.

Integration in mechanical Master key system

A Master key system with ASSA dp technology provides CLIQ integration in one or more doors without changing the rest of the Master key system.

Characteristics

The ASSA CLIQ is approved by insurance companies for inclusion in approved lock sets. The system is easy to integrate with doors that require off line security. CLIQ consists of a high security cylinder with mechanical and electromechanical blocking elements. The key consists of a patented mechanical code and a unique electronic code. Information stored in the key is transmitted through a contact rail to be approved and registered in the cylinder.

Function

Since the units are powered by the battery in the key, CLIQ cylinders do not require any wiring. This makes the installation, retrofitting and after-sales service very easy. You can combine a variety of auxiliary cylinders, padlocks and cylinder shapes in a CLIQ lock system. The cylinder has a chip with a memory, processor and operational circuit board built in. The key has a corresponding chip placed in the bow. The programmed electronic code in the key cooperates with the electronics of the cylinder and its built-in motor. All information is encrypted by DES. This ensures a secure digital communications between keys, cylinders and programming units. The mechanical combinations and the electronic codes cooperate with each other to create a very high level of security with great flexibility.

PC software, ASSA Performer

Keys and cylinders have digital labeling for simple PC administration. All keys included in the system are granted authorization with special software, ASSA Performer. The master key system's C key is used to program cylinders and to change the authorization of groups or individuals.



ASSA dp CLIQ

UKT User key

The user's key. Consists of mechanical combinations, electronics for identification and battery for power supply.

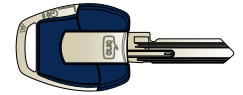

CK Programming key

The system operator's key. It is used to activate and deactivate keys for specific cylinders. It can carry information to adapt authorization and/or read the cylinder history. Cylinder programming is not possible without the object's Set-Up key.

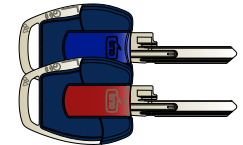

PDK Contact key

The system operator's key. The contact key is used to identify cylinders and when expanding the lock system.



DK Service key

The service station's key. It is used for identification between ASSA and the service station, in digital communication and as complement to CLIQ keys and cylinders.

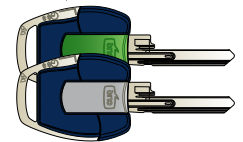

Cylinders

Delivered in round and oval format or various types of padlocks. The cylinder is certified by SBSC AB and meets the requirements for SS3522, class 3. SSEN 1303 Grade 6.



Power supply

Lithium battery of standard 2025 type.



Terminal

Programming unit for programming and activating cylinders and keys with CLIQ function.





ASSA dp 4400

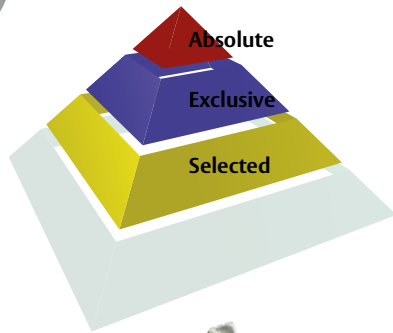

Application

The ASSA dp 4400 series is a high-security cylinder with a patented security level, recommended for all types of mechanical locking systems. All master key systems let you specify high and medium-security cylinders as well as auxiliary cylinders such as padlocks and camlocks. For this reason the ASSA dp series is the ideal solution for all types of operations and buildings. The CLIQ off line function can be added to the cylinders to provide a higher level of flexibility and security where so required, for instance perimeter protection and other important spaces where the security requirements are higher. If on-line functionality allowing instant and direct changes, the twintronic system offers optimal security and flexibility to the protection of your premises.

Features

- The ASSA dp 4400 series meets the requirements according to SS3522, EN1303, security Grade 6
- Protection against physical attack and picking
- The double performance technology with scrambled combinations on both blocking elements offers optimal protection against manipulation



To order with the CLIQ function, add index B before the catalog number. Example for the ASSA dp cylinder series: B4401.

For dp tronic function, add index E before the catalog number. For example: 4401 => E4401

For a complete description of all CLIQ and twintronic functions, see the respective product information leaflet.

Function

ASSA dp technology is protected by national and international patents against copying of keys, un-authorized use of key blanks and also cylinder components. The ASSA dp platform is uses two independently working blocking mechanisms for protection against physical attack, picking and manipulation. Different cylinder shapes (Scandinavian, Euro profile and Mortice, etc.) and functions can be combined in the same locking system for mechanical, off line and on line cylinders. The patented technology within the dp platform lets you create unique parallel system solutions with a variety of key combinations and cylinder performances. This makes the dp platform ideal for use in both unique custom-made solutions as well as traditional master key system configuration. The dp technology allows easy upgrading of CLIQ, RFID and other future technologies. ASSA dp uses force-controlled horizontal blocking elements for enhanced operational security and usage in aggressive environments where the risk of freezing and condensation is high. Using force-controlled horizontal blocking elements also reduces friction and minimizes wear and tear on the keys and cylinder components. The ASSA dp 4400 can be combined with the ASSA dp 2400 series for doors where the security demands do not require approved locking.

ASSA dp 2400

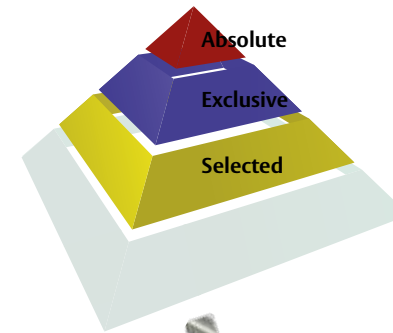

Application

The ASSA dp 2400 series is a medium-security cylinder with a selected security level, recommended for doors where the security demands do not require approved locking.

Features

Dual-performance technology of blocking elements. For a range of cylinder shapes.

Function

The ASSA dp 2400 range for integration in dp 4400 series master key systems.

- For frequent use
- For aggressive environments
- For controlled access



Door key deposit 88



Application

Recommended as a lock complement in hall and exterior doors of apartment buildings, special housing for the elderly and disabled, townhouses, etc. Primarily used for temporary storage of apartment keys, for example when the resident is not at home at the time of scheduled apartment maintenance.

You mount the cover on the inside of the door key deposit, which is designed so it can be adjusted to the right door thickness during installation.

Features

- ASSA door key deposits are available for door thickness of 37 mm to 97 mm. The deposit should be mounted in the door blade at the top corner on the hinge side.
- Protects against picking and physical attack

Function

When maintenance has been agreed on and notified:

- 1) The resident places the apartment key in the door key deposit.
- 2) The maintenance person

- Opens the door key deposit from the outside with the maintenance key.
 - Takes out the apartment key from the deposit box and opens the door.
 - Locks the door and returns the key in the door key deposit.
- 3) The resident
 - Removes the key from the inside of the door after completed maintenance.

Range

4488 Cylinder without keys

Door key deposit, excluding cylinder 89.

Door key deposit, for door thickness 37–97 mm.

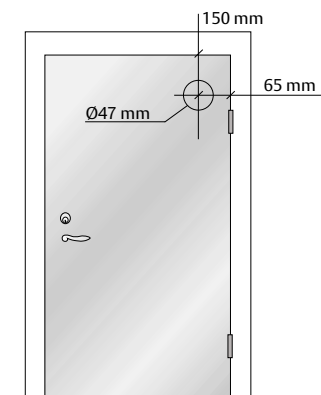

Recommended installation position



To order with the CLIQ function, add index B before the catalog number. Example for the ASSA dp cylinder series: B4488.

For a complete description of all CLIQ functions, see the respective product information leaflet.



Wall key deposit 18



Application

The ASSA Wall key deposit is designed for temporary storage of individual entrance keys to buildings or, integrated in designated building areas. Authorized maintenance or emergency personnel may gain access to the building using a unique maintenance key to open the deposit and take out the entrance key.

Function

Maintenance providers and emergency services are authorized to open the wall key deposit with the unique maintenance key of the building. They use the entrance key to gain access to the building and perform the intended maintenance or carry out emergency operations. Afterwards, the building is locked and the maintenance key is returned to the wall key deposit.

Features

To prevent vandalism, the wall key deposit should be installed in a concrete wall of quality K250 or higher. Install at least 1,500 mm above ground level.

The wall key deposit must incorporate an approved ASSA high-security cylinder where the keys have a minimum key control level of SELECTED to ensure protection against unauthorised copying. For optimized security, the cylinder and the key of the wall key deposit should not be included in the building's master key system. The wall key deposit can be equipped with a built-in microswitch for alarm indication.

Protected against vandalism

- To be used in combination with a specially designed, approved high-security cylinder such as ASSA dp
- Protected against picking and manipulation.
- Designed primarily for mounting in a concrete wall.
- Steel tube Ø 45 mm, protected against corrosion.
- Suitable accessories for mounting include an expander bolt or a washer with a threaded bolt.

Range

4418 ASSA dp Cylinder

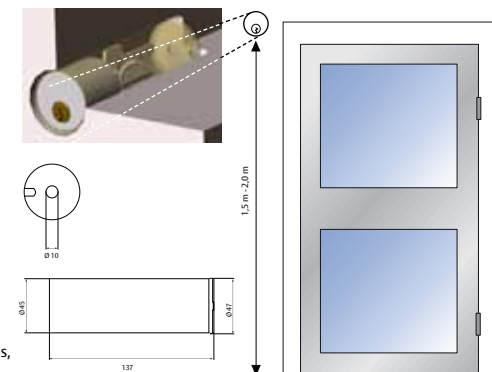

To order with the CLIQ function, add index B before the catalog number. Example for the ASSA dp cylinder series: B4418.

For a complete description of all CLIQ functions, see the respective product information leaflet.



Utility lock 80



Application

ASSA Utility locks are used for any applications where locking is desired but regular locks or padlocks are not possible. ASSA utility locks can be used for windows, patio doors and also for office furniture.

Function

ASSA utility locks are fitted with a push-button cylinder that is locked together when pushed into the strike plate. The technique is excellent for usage with movable items like drawers and light doors that did not come with built-in locks. The key can be retracted both in locked and unlocked position. ASSA Utility locks can be combined in a Master key system and are available with a variety of cylinder ranges.

Features

The lock must be installed in the correct position depending on whether the door/window opens inward or outward. Check the thickness of the window frame to ensure that it can hold screws of this length.

Range

2480 Utility lock, ASSA dp 2400 series
680 Utility lock, Restricted level

Fitting

ASSA window locks have concealed fittings. The fitting screws cannot be accessed when the window is locked.

Versions

The window lock can be combined with ASSA Twin or ASSA Max cylinders. It is suitable for master keyed, keyed different and keyed alike cylinders.

Finish

Body and striking plate white powder lacquer (067), cylinder bright chrome (11).

Inward opening

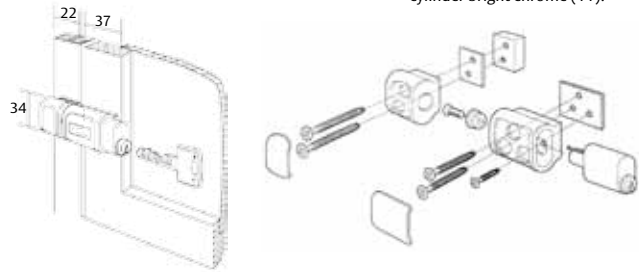

Outward opening

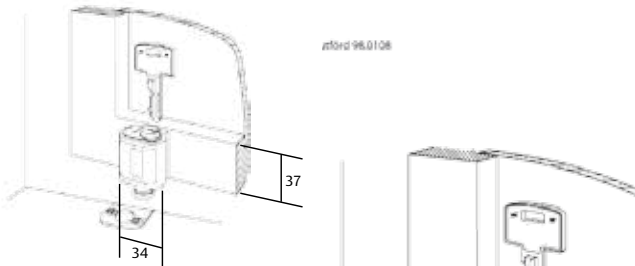

Notes



Series of horizontal lines for notes.



Cam lock ASSA 71



Application

ASSA cam locks 2471 and 671 are cylinder locks for installation in cabinet doors, which can be implemented in a master key system together with other cylinder shapes.

This solution adds convenience to many installations by allowing users to open entrance doors, office doors and for instance a postal locker with a single key. Other areas where cam locks are perfect to install are electrical cabinets, recreation areas, schools and storage facilities in shops.

Function

ASSA cam locks are fitted into cabinet doors and will be locked by a catch that is operated by the key. ASSA camlocks are easy to adjust to door thicknesses of up to 23 mm. ASSA cam locks are available in different security levels depending on the users' needs:

- 2471
- 671

Features

Catches must be ordered separately. For alternative designs of catches, contact your local ASSA distributor. Cyllindering helps to build up a distance in a thin door and support the installation.

A nail plate helps to support installation so that the cylinder will not turn when installed in the door.



To order with the CLIQ function, add index B before the catalog number. Example for the ASSA dp cylinder series: B2471.

For a complete description of all CLIQ functions, see the respective product information leaflet.



Cam lock ASSA 71

Dimensions

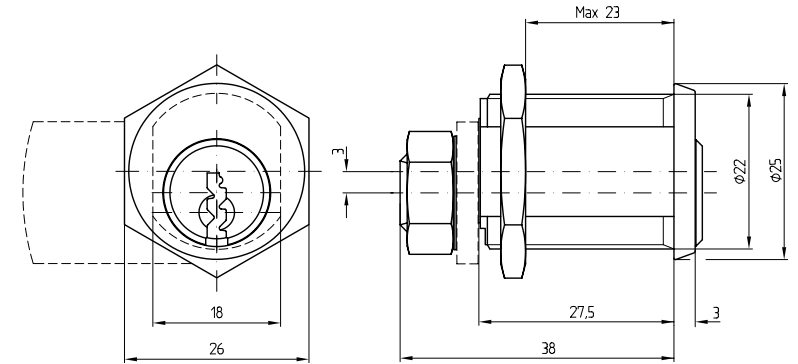

Catches

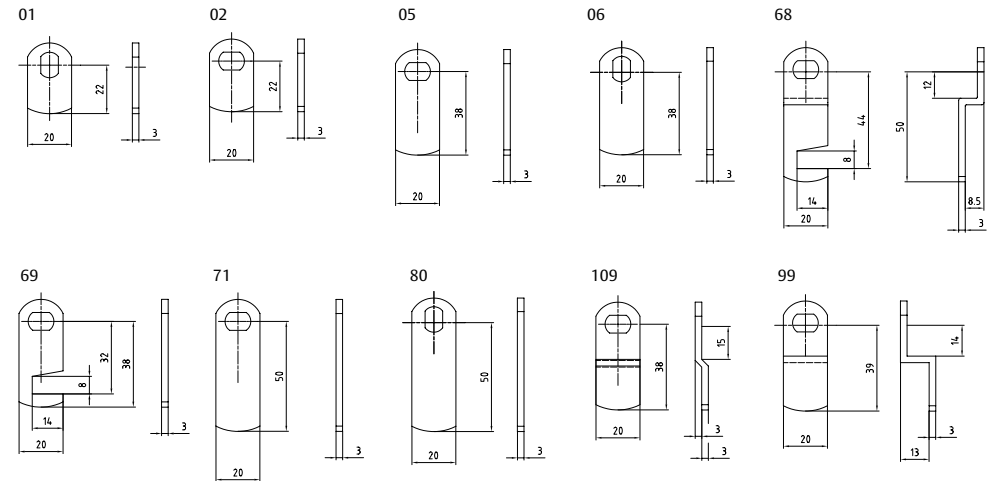

Cylinder ring

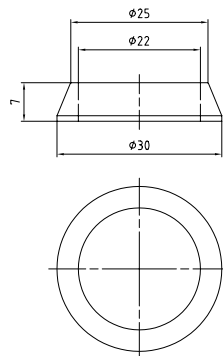

Nail plate

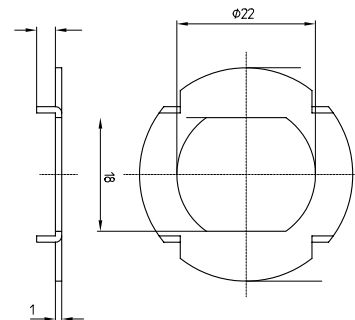

Door preparation

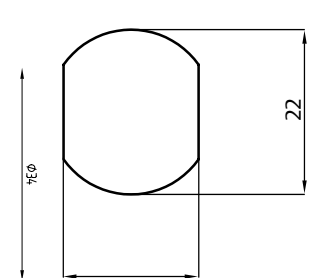

Master key systems

Master key systems



ASSA M20 cylinders



Application

The ASSA M20 cylinder range is designed to be installed into EURO profile locksets. The EURO cylinders can be integrated in ASSA Master key systems with Scandinavian and other international cylinder shapes.

Features

The ASSA M20 cylinder range is available as a double cylinder, with a thumbturn or as a single cylinder. It is a modular cylinder, which means it can easily be rebuilt to various lengths to fit varying door thicknesses. When an organization changes or a building is modified, it is simple to alter the cylinder to achieve new functions. The M20 cylinder range meets the requirements in EN 1303 attack resistance grade 2 and key-related security grade 6.

Function

The M20 cylinder is available in two different security levels. This makes it possible to combine the security levels to achieve high or medium-security in the same Master key system. The high security cylinder has drill and picking protection. The medium security cylinder is designed to meet the security demands for ASSA SELECTED key control. Cylinders and padlocks can be incorporated in the same Master key system.

Guideline for M20 EURO accessories

Location of lock cases, cylinders and accessories

1. Specification of M20 cylinder/thumbturn and accessories.
- a) Measure the door thickness (A).
- b) Measure the distance between the center of the lock case and the security side of the door (B).
- c) Measure the distance between the center of the lock case and the inside of the door (C).
- d) Add the thickness of the cylinder accessories to the B and C measurements. The result will be the length of the cylinder/thumbturn.



To order with the CLIQ function, add index B before the catalog number. Example for the ASSA dp cylinder series: B44M22.

For a complete description of all CLIQ functions, see the product information leaflet for CLIQ.

Table measurement

Code	Length mm
A	+0
B	+5
C	+10
D	+15
E	+20
F	+25
G	+30
H	+35
I	+40
J	+45
K	+50
L	+55

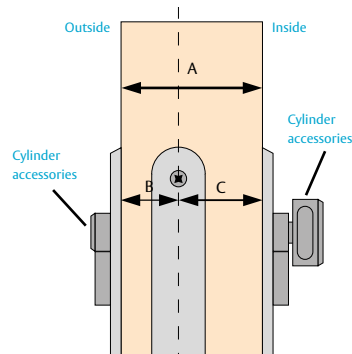

ASSA M20 cylinders

Double cylinder	Single cylinder
<p>Extension outside (A=+0 mm) Cylinder shape Cylinder series Extension inside (C=+10 mm)</p> <p>61 M 22 A C</p> <p>Extension outside Cylinder length 61 mm Extension inside</p> <p>Code</p>	<p>Extension (C=+10 mm) Cylinder shape Cylinder series</p> <p>61 M 23 C</p> <p>Extension outside Cylinder length 40 mm</p> <p>Code</p>
XXM22/25	XXM23

Cylinder, designed thumbturn	Cylinder, narrow-profile thumbturn
<p>Extension outside (A=+0 mm) Cylinder shape Cylinder series Extension inside (C=+10 mm)</p> <p>61 M 24 A C</p> <p>Extension outside Cylinder length 61 mm Extension inside</p> <p>Code</p>	<p>Extension outside (A=+0 mm) Cylinder shape Cylinder series Extension inside (C=+10 mm)</p> <p>61 M 24 A C</p> <p>Extension outside Cylinder length 61 mm Extension inside</p> <p>Code</p>
XXM27	XXM24

M20 Modular accessories

XXM22/25 Double Cylinder

Beam	House extension 1	House extension 2	Plug extension 1	Plug extension 2	Key extension	Turn extension

XXM27 Turn Cylinder

Beam	House extension 1	House extension 2	Plug extension 1	Plug extension 2	Key extension	Turn extension	Clutch

XXM23 Single Cylinder

Beam	House extension	Plug extension



ASSA P600

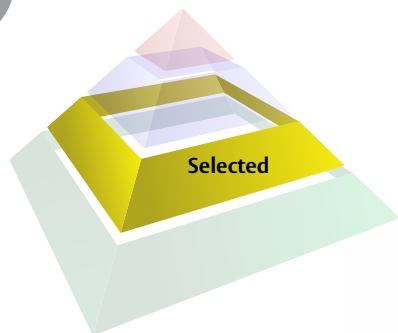

Application

ASSA P600 is based on a new pin technology together with a paracentric key profile. It is a new way of thinking; the aim is to create a new standard cylinder used for master key systems in a simple way but without compromise.

The security of ASSA P600 cylinder is high and the functionality is thoroughly tested and very reliable.

The next generation of patented cylinders, the ASSA P600, is ideal for a variety of master key applications from office suites and residential blocks to classrooms and hospital wards.

Function

A full range of cylinder shapes is available in ASSA P600, allowing the system to be used with all common makes of lock cases. With ASSA P600 it is possible to make a system covering all applications, from outer- and inner doors, over lockers and mailboxes to padlocks.

Euro profile and UK oval profile cylinders can be supplied with special functions, such as key-override of knob, dual sided locking, floating cam piece etc.

Features

ASSA P600 has been designed with the building owner needs and demands in mind. The system offers the flexibility to provide a solution for different master key applications including cylinder variants for aluminum, plastic, timber and steel doors, etc.

- Patented keys and technology provide maximum protection against unauthorised duplication
- Patented cylinder technology, pins, inner and key profile
- Paracentric key profile giving high resistance against all known methods of picking
- Meets the requirements of bump resistance in accordance with British Standards
- Certified according to EN1303, grade 6;0
- Key blanks are protected by patent ensuring keyblanks cannot be manufactured by unauthorised parties
- ASSA P600 is precision engineered using high-quality materials ensuring the longevity of both cylinders and keys
- A full ASSA P600 master key system design service is available
- Well tested and proven technology
- Fits all applications due to complete range in cylinder shapes and functions
- Cylinder house and inner with hardened steel inserts for drill resistance
- Can be used with all common security hardware due to extended keyneck

ASSA P600



Key

Extended keyneck allows the use of security accessories on Euro profile cylinders.

Pins

Special security pins with wings and 2 tips on each pin together with the combinations of the master keying codes, make the cylinder highly bump resistant.

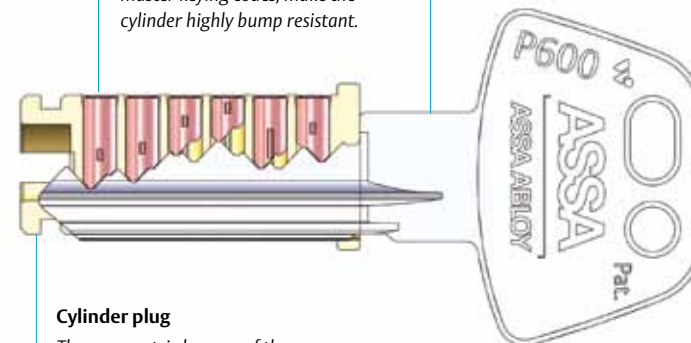

Cylinder plug

The paracentric keyway of the inner offers high protection against picking. A minimum inner projection allows the use of security accessories.



ASSA Green padlock

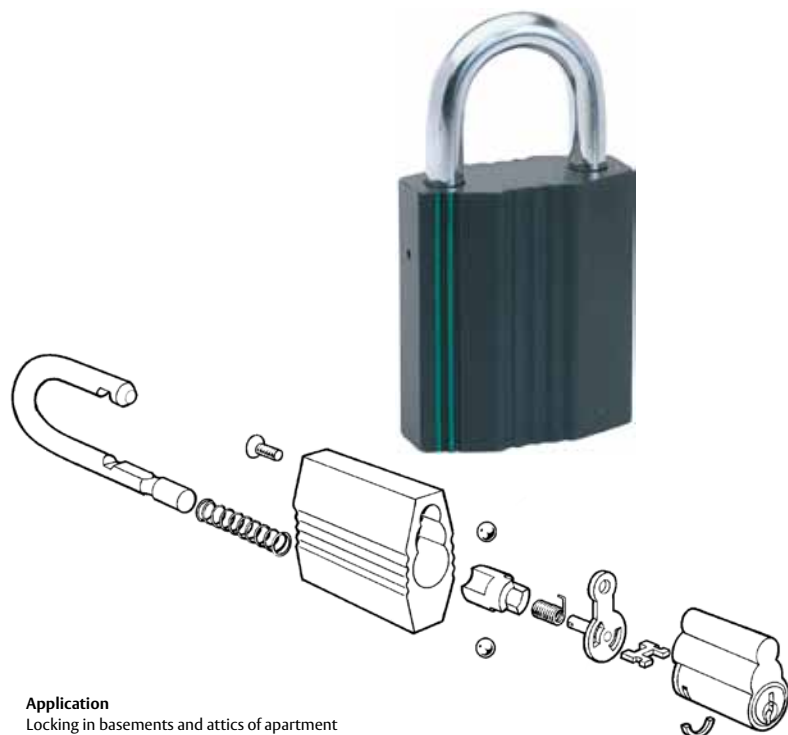

Application

Locking in basements and attics of apartment buildings, internal locking of Grade 1 and 2 grilles and hatches, locking of boats under 200 kg and locking of approved bicycle chains.

Features

- Padlock with black chrome finish and bright chrome shackle
- Padlock body of brass
- Condensation drainage holes to reduce the risk of freezing
- Designed for alternative cylinder types
- Shackle Ø 8 mm or 10 mm of corrosion-protected, hardened steel or brass
- Pull resistance over 15 kN
- Available in several shackle heights, see dimensional drawing and table on the previous page

Function

Designed for the following cylinder series:

- ASSA dp
- ASSA 600

See ASSA Padlocks, overview, page 85.

Available with the following functions

- Snap locking
- Key locking



ASSA Blue padlock

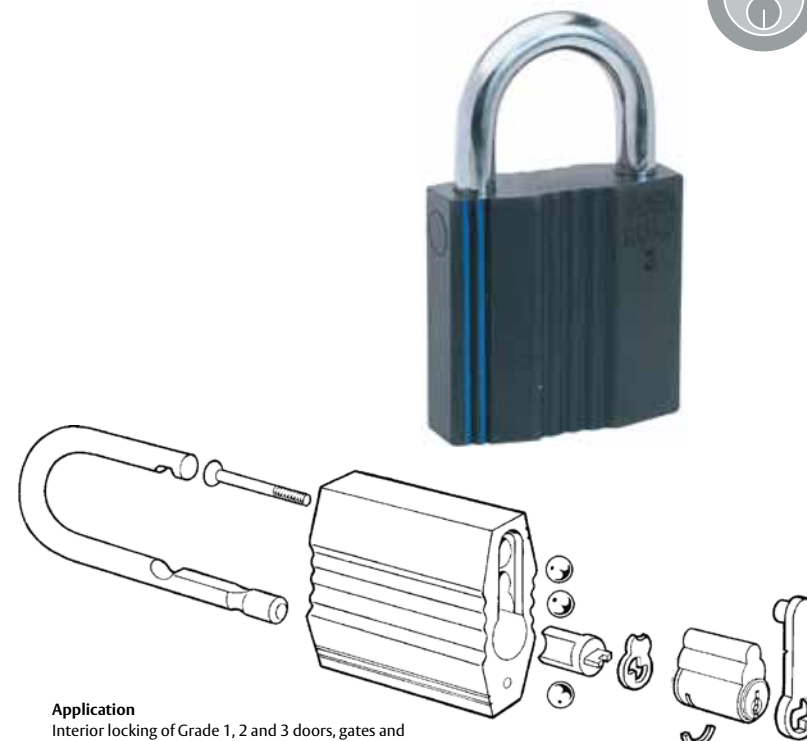

Application

Interior locking of Grade 1, 2 and 3 doors, gates and hatches as well as interior locking of Grade 3 grilles, locking of motorcycles, mopeds, boats over 200 kg and boat engines.

Features

- Padlock with black chrome finish and bright chrome shackle
- Padlock body of hardened steel
- Condensation drainage holes to reduce the risk of freezing
- With drill-protected cylinder
- Shackle Ø 10 mm of corrosion-protected, hardened steel
- Designed for alternative cylinder types
- Pull resistance over 35 kN

Function

Designed for the following cylinder series:

- ASSA dp
- ASSA 600

See ASSA Padlocks, overview, page 85.

Available with the following functions

- Key locking



ASSA Red padlock

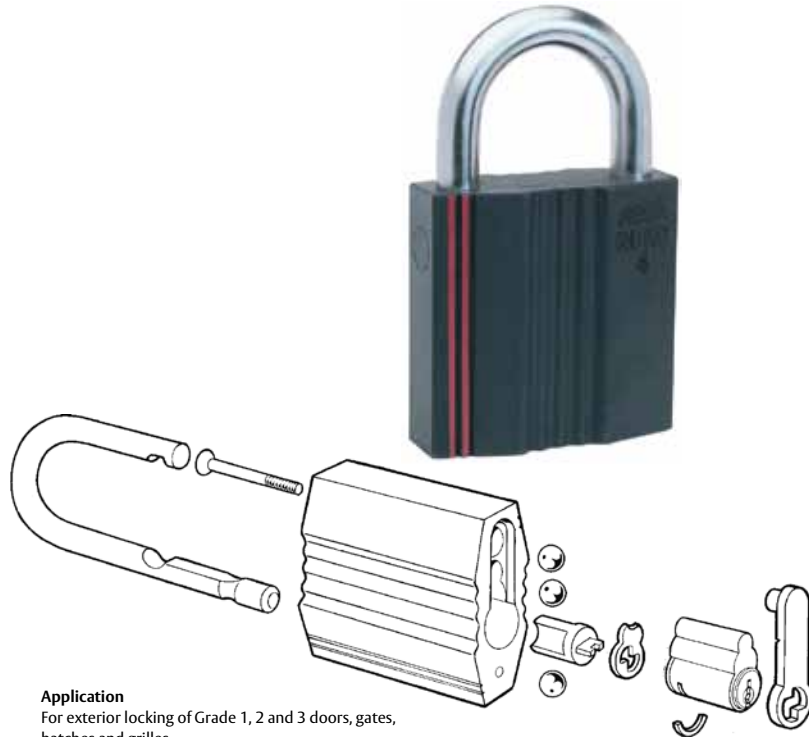

Application

For exterior locking of Grade 1, 2 and 3 doors, gates, hatches and grilles.

Features

- Shackle padlock with black chrome finish and bright chrome shackle
- Padlock body of hardened steel
- Condensation drainage holes to reduce the risk of freezing
- With drill-protected cylinder
- Shackle Ø 13 mm of corrosion-protected, hardened steel
- Designed for alternative cylinder types
- Pull resistance over 70 kN

Function

Designed for the following cylinder series:

- ASSA dp
- ASSA 600

See ASSA Padlocks, overview, page 85.

Available with the following functions

- Key locking

ASSA Padlocks, overview

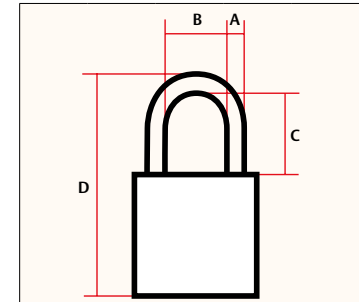
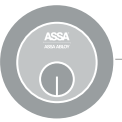

Padlock Grade	ASSA dp			Shackle dimensions					Snap locking	Key locking
	ASSA 600 series	Medium-security	High-security	A	B	C	D	Mtrl		
Green	640	24240	44240	8	24	27	91	Steel	x	
Green	641	24241	44241	8	24	27	91	Steel		x
Green	646	24246	44246	10	22	26	92	Steel		x
Green	647	24247	44247	10	22	51	117	Steel		x
Blue	641		44341	10	33	31	102	Steel		x
Red	641		44441	13	44	40	133	Steel		x
Not classified										
-	643	24243		8	24	52	116	Steel		x
-	644	24244		8	24	52	116	Brass		x
-	645	24245		8	24	27	91	Brass		x



ASSA Lock Spray is a lubricant and Cleaner/De-Icer with a new improved formula. Use it to significantly enhance the reliability and longevity of mechanical and electromechanical cylinders.

Features

- EFFECTIVE – small dosage gives quick results
- RAPID DRYING – does not bind dust and grit
- WATER RESISTANT – does not bind salt, protects against corrosion
- SERVICE AND MAINTENANCE – recommended twice a year or according to the building's service schedule
- ANTI FREEZE – De-Icing and anti-freezing properties

Cleaning instructions

Shake before using. Insert the spray nozzle into the keyway of the cylinder and press the button for one second. Remove the nozzle from the keyway, insert the key and turn a couple of times. Wipe the key clean of any excess lubricant.

De-Icing instructions

Shake before using. Insert the spray nozzle into the keyway of the cylinder and press the button for one to two seconds. Wait 30 seconds, then insert the key and turn a couple of times. Wipe the key clean of any excess lubricant. Repeat if necessary. To prevent further freezing, repeat the lubrication process within a few days.



Service and maintenance

Several factors can affect the opening and closing of a door. To ensure the best functionality and durability, all doors require regular service and preventive maintenance.

Lock cylinder and keys

Service and maintenance is recommended twice a year or according to the building's service schedule.

Always use ASSA Lock Spray

A conventional lockspray may clog a mechanical cylinder and damage an electromechanical cylinder. For locks in frequently used doors or locks exposed to harsh environmental conditions we recommend more frequent lubrication.

To avoid any disruptions in functionality due to condensation and/or freezing, maintenance should be scheduled before the winter period in cold climates.

ASSA electro mechanical functions, such as CLIQ, should be tested in accordance to the buildings maintenance agreement. A yearly test of the electro mechanical functionality is also recommended. The battery capacity of CLIQ keys should be checked once a year.

Keys with high usage tend to wear and should be replaced if the user experiences reduced opening functionality of the cylinder.

Warning!

Never use grease, oil or graphite-based lubricants in locking cylinders, as these lubricants cause disruptions in functionality and clog up the mechanism.

Cylinders

	Never OIL or GRAPHITE
	Do not paint the cylinder
	Avoid filings
	Cylinder assembly - Accuracy - Quality
	Service/Maintenance - Frequency/5,000 cycles - Functionality disruptions - According to maintenance agreement
	Lubrication - At point of assembly - Twice a year or according to scheduled service/maintenance - Counteracts condensation

Keys

	Deteriorating operation - Frequency/5,000 cycles - Copying - Mechanical wear and tear
	Key cutting - Cut depth/tolerance - Precision - Equipment
	Key identity - Always stamp - According to system documents
	Key control - Authority - Registration - Security folder
	Battery level



Scandinavian shapes				
Type		4400	2400	P600
Scandinavian round Single outside		4411	—	P611
Scandinavian round Single inside		4413	—	P613
Scandinavian round Double		4412	—	P612
Scandinavian oval Single outside		4401	2401	P601
Scandinavian oval Single inside		4403	2403	P603
Scandinavian oval Double		4402	2402	P602
Scandinavian oval Rim cupboard		4407	2407	P607
Scandinavian oval Rim		4408	2408	P608
Scandinavian oval Rim		4409	2409	P609
Camlocks				
Type		4400	2400	P600
ASSA Camlocks Ø22 mm		—	2471	P671
Mortice				
Type		4400	2400	P600
Adams rite		4451-1	2451-1	P651-1
Sargent cam		4451-2	2451-2	P651-2
Corbin clover		4451-3	2451-3	P651-3
Corbin beaver		4451-4	2451-4	P651-4
Yale cam		4451-5	2451-5	P651-5
Schlage L cam		4451-6	2451-6	P651-6
Segal		4451-7	2451-7	P651-7

A 1 1/8 Ex. 4451A-1
B 1 1/4 Ex. 4451B-1









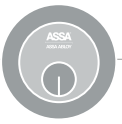







DIN cylinders				
Type		4400	2400	P600
Euro profile Double		44M22 44M25	24M22	P6M22
Euro profile Single		44M23	24M23	P6M23
Euro profile Single small turn		44M24	24M24	P6M24
Euro profile Single large turn		44M27	24M27	P6M27
Rim mortice				
Type		4400	2400	P600
Rim mortice Horizontal tail		4457-1	2457-1	P657-1
Rim mortice Lazymotion tail		4457-2	2457-2	P657-2
Rim mortice Vertical tail		4457-3	2457-3	P657-3
British oval				
Type		4400	2400	P600
British oval Single turn		4437	2437	P637
British oval Oval double		4432	2432	P632
British oval Oval single		4423	2423	P623
British oval Single small turn		4434	2434	P634



Key in knob				
Type	4400	2400	P600	
Key in knob Yale Std, HD 	4463-1 	2463-1	—	
Key in knob Schlage Std, HD 	4461-1 	2461-1	—	
Key in knob Arrow Std, HD 	4469-1 	2469-1	—	
Key in knob Falcon series S&X 	4466-1 	2466-1	—	
Key in knob Corbin HD 	4465-1 	2465-1	—	
Key in knob Corbin Std 	4465-2 	2465-2	—	
Key in knob Corbin russwin 19F35 	4465-3 	2465-3	—	
Key in knob Corbin russwin 25F26 	4465-4 	2465-4	—	
Key in knob Corbin russwin 25F65 	4465-5 	2465-5	—	
Key in knob Sargent integra 	4467-1 	2467-1	—	
Key in knob Sargent HD 	4467-2 	2467-2	—	
Key in knob Sargent Std 	4467-3 	2467-3	—	
Cylinder set, Panic device				
Type	4400	2400	P600	
Cylinder set, Panic device 	4425 	—	P625	



Key deposit				
Type	4400	2400	P600	
Wall key deposit 	4418 	—	—	
Door key deposit 	4488 	—	—	
Removable core				
Type	4400	2400	P600	
Removable core 	—	2459 	—	
Deadbolts				
Type	4400	2400	P600	
Deadbolt outside 	44811 	—	—	
Deadbolt inside 	44813 	—	—	
Deadbolt double 	44812 	—	—	
Mogul cylinders				
Type	4400	2400	P600	
1-1/8" Mogul Cylinder AirTeq/Norment R.R. Brink 	44251-1 	—	—	
1-1/2" Mogul Cylinder Southern Steel Folger Adam AirTeq/Norment Adtech 	44251-2 	—	—	



To order with the CLIQ function, add index B before the catalog number. Example for the ASSA dp cylinder series: B4418.

For a complete description of all CLIQ functions, see the respective product information leaflet.



SOFTWARE

Good communication between computers at different locations has the same basic premise as conversation between people, i.e. they have to speak the same language. This was the starting point when ASSA began developing three different – but very similar – computer programs made for different user groups in the field of locks and security.

Our specially designed software, with internal security routines, calculates and manages master keyed systems. This guarantees optimal security the calculation and production of the system. The database contains all information pertaining to system. All corrections and changes communicated to ASSA are registered, so we can provide fast and correct information. For more information about our software, visit www.assa.se.





ASSA

ASSAs emphasis on data communication is embodied in the design, calculation and archive services of our master keyed systems (MKS), as well as our own production management. ASSA Security Master is used for both designing and creating the MKSs.

ASSA Security Master also communicates with ASSAs own mainframe. This means that the manufacturing of keys and cylinders is controlled by information from the lock chart. Whether the original design came from ASSA or a security contractor, locking is registered in the mainframe archive database. This lays the foundations for a well-functioning service and ensures ease of future expansions of the system.

Security Manager

The main software our MKS distributors need is for designing and creating the lock chart and for processing the MKS after-sale service. New objects and ROOT objects appear side by side. Though our distributors use ASSA Security Master, they do not communicate directly with ASSAs mainframe. After creating an MKS data file in ASSA Security Master , the locksmith transfers it to ASSA over the Internet for calculation. One important report is the mounting list, which tells the locksmith where each product should be mounted in an object.

System owner

The system owner uses the computer exclusively for handling keys, which both simplifies management and enhances security. ASSAs key management program, ASSA Performer, gives the system owner will get quick and easy answers about the key issued, who has the key and what spaces they have access to.

Input

Basic data of the MKS.
File with MKS details from security manager, architect, or security consultant. Building drawing. Survey by the ROOT objects.

Input

Basic data of the MKS.
File with information from security manager, architect, or security consultant. Building Drawing. Survey by the ROOT objects.

Input

File with MKS data.
Personnel register

Output

Lock chart. Quote.
Order Basis.
Authorization contract.
Fitting Specification.
Mounting List. Key and cylinder list.
Combination list.

Output

Lock chart. Quote.
Order Basis.
Authorization contract.
Fitting Specification.
Mounting List. Key and cylinder list.
Combination/pinning list.

Output

Lock chart. Personnel register. List of keys.
Handed out keys.
Lost, stolen keys. Key management: includes distribution, return, claims letters, key orders, etc.



Information flow – Mechanical and CLIQ master keyed system

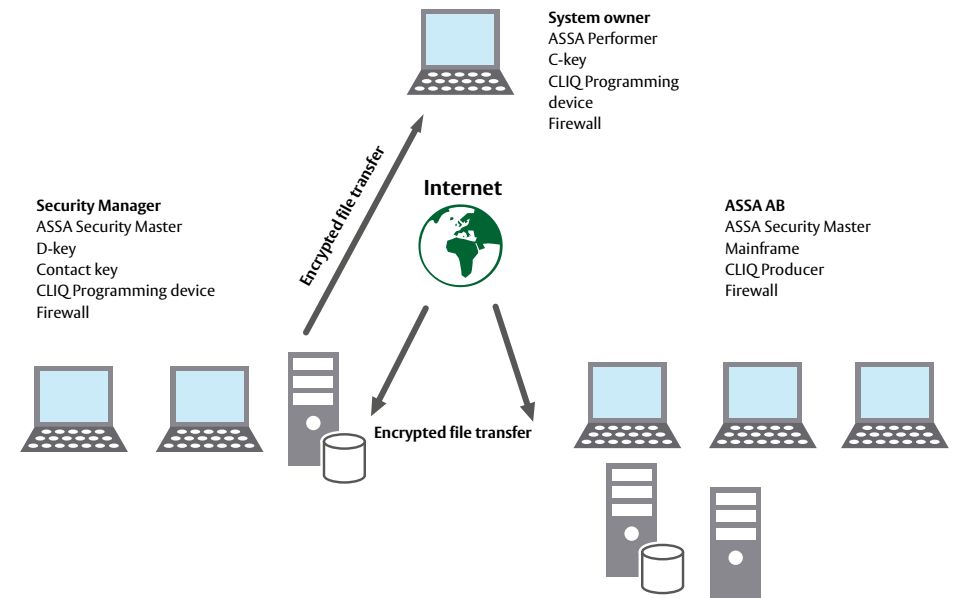



Application

The CLIQ Remote locking system offers advanced security and convenient access management for master-key locking environments.

Software as a Service (SaaS) operated CLIQ Web Manager enables advanced multi site programming, administration and management of CLIQ Remote locks in combination with the CLIQ Terminal programming device and a Microsoft Windows based PC. Updates to the user keys can then be distributed through a Wall PD update unit.

The CLIQ Web Manager provides high security functions and a process regarding data management of the end customer's locking system. All lock and key programming operations requires physical admin keys and PIN codes to process programming tasks. This procedure ensures high system security.

Features

- Convenient management of CLIQ Remote locks and CLIQ Remote keys
- Access right definition, restriction and change
- Time restrictions
- Automatic key overwrite
- Key Revalidation
- Blocking of lost keys
- Audit trail reports
- Central management
- 24/7 uptime as Software as a Service (SaaS)
- Admin domains
- Customizable admin roles
- Easy installation in the Web-browser
- Automatic backups and updates
- User-friendly Graphical User Interface (GUI)



CLIQ Remote Lock system

Central administration is one of the core benefits with CLIQ Web Manager. The administrator can change access rights on keys without having to bring them in.

- Cylinders and keys are easily overviewed
- Overdue keys can be blocked from access.
- Hand in/out receipts can be printed



Tags and external links

For improved search ability content in the lock system can be tagged with information:

- Department
- City



External links may be applied to point to selected webaddresses.

Example:

- Show a map where the cylinder is placed
- A photograph of the employees from a photo database

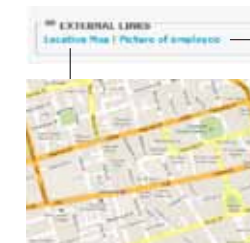

Access profiles

Access profiles are a valuable function when administrating large systems. With access profiles, you can connect certain cylinders to a profile once, and when handing out a key to an employee or visitor with this profile, this person will automatically have access to all cylinders given in the access profile.

Audit trail

A central audit trail archive allows for easy overview of what happens in the lock system. The logs are synced automatically when keys are updated by the user.

20/01/13 14:55	Erik Johansson	Access	OK (MMS)
20/01/13 14:22	Erik Johansson	No Command	Denied

CLIQ Web Manager System requirements

- Client operating system: Microsoft Windows XP SP3, Vista, 7
- Client Internet browser: Microsoft Windows Explorer 7, 8, 9 -> Mozilla Fire Fox 32bit 16.0 ->
- Client application Oracle Java 2.8, or newer
- Client login verification with Programming Key and PIN code

CLIQ Web Manager Server

- Server management According to: ISO27001 Information Security Management System, ISMS - Requirements
- Service availability 24hours /7 days, maximum maintenance break 4 hours
- Client server communication SLL secured web service connection (TCP port 443)

CLIQ Remote locking system capacity

- Amount of keys per locking system up to 65 000 keys
- Amount of locks per locking system up to 65 000 locks
- Amount of locks per cylinder group up to 65 000 locks
- Amount of key owners per locking system: Unlimited
- Amount of administration domains per system: Unlimited
- Amount of administrators per locking system up to 100
- Lock audit trail capacity: 1000 latest events
- Key audit trail capacity: 100 latest events
- System event log archive capacity: Unlimited



Key administration

ASSA developed its ASSA Performer software to help system administrators manage the keys in their Master Key Systems. As long as you maintain control of all your keys, your Master Key System will remain secure. If you lose this control, the security can be compromised.

There are four questions you must be aware of in key administration:

1. What keys have been distributed?
2. To whom have these keys been distributed?
3. What doors can a key holder access?
4. When are the keys due to be returned?

Manual key management is time consuming. It also increases the risk of errors. ASSA Performer gives you enhanced control of your lock system.



ASSA Performer is user friendly software with many functions that will improve the management of your security system – some of the functions include:

- Managing contacts and addresses
- Distributing and receiving keys
- Changing status of keys, for instance if one is reported lost or stolen
- Ordering keys from your supplier
- Generating reminders for distribution and return dates and times
- Search functions
- Finding out what a specific key goes to
- Finding out which keys and users have access to a specific cylinder
- Printing an array of reports
- Printing receipts for keys that have been distributed or returned



ASSA CLIQ

ASSA Performer can also manage a Master Key System with ASSA CLIQ functionality. This means that mechanical and electronic elements are combined in the same Master Key System.

With ASSA Performer, you give CLIQ keys access to CLIQ cylinders, which dramatically increases the flexibility of your Master Key System. You can also remove access, which helps you to maintain security in your Master Key System if a key is lost or stolen. Contact your ASSA representative for more information on ASSA CLIQ.

Practical advice for key security

- Inform the key holders who is responsible for the Master Key System
- Inform the key holder of the value the key represents
- Always get a signed receipt for each key distributed
- Audit the key stock regularly



System requirements

- For system requirements, see www.assa.se

Functions

The lock chart in Performer looks exactly the same as the lock chart that the locksmith and ASSA both use. Having the same information makes communication much easier.

ASSA Performer can be connected to Microsoft® Outlook or Microsoft® Exchange. This makes key management easier because you only need to maintain one personal list of contacts. You can also receive reminders from ASSA Performer in the Microsoft® Outlook Calendar.

ASSA Performer works on a single computer running Windows, or in a network. ASSA Performer can handle a virtually unlimited number of people, keys, cylinders and Master Key Systems.

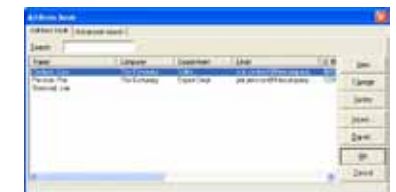

Product information

Product information	Article number
ASSA Performer	880581 590 000
ASSA Performer with Outlook connection	880658 590 000
Upgrade to Outlook connection	880659 590 000
Create local system	880731 590 000
Door module	820411 021 000
Change in Lock chart	820411 022 000
Performer Network licenses	880770 590 000



ARX Access is an online system with components that communicate with each other. The control units decide whether or not to permit entry according to a schedule for the door environments, without having to go through the system server. This means that the system can maintain the same security and functionality even in the event of a communication breakdown.

The ARX Access system includes the following components:

1. ARX Server manager – software for system communication

The ARX Server software communicates with the system's control units via the LAN. It is configured from the system's client software. Rules for automatic backup of the system's database can be set up from the server software's interface. Where there is no LAN, a modem can be used for communication.

2. ARX client software for configuration and administration

All configuration and administration of the system is done in the ARX client software. It consists of a graphical user interface that is easy to adapt for different types of system operators. The client software can be installed on several clients in the network, depending on the customer's needs. Clients can also be connected over the Internet.

3. Where the decisions are made

The control units in an ARX Access system are connected to the existing LAN and thus have a secure link to the server. ARX control units work auto-nomously,

which means that all decisions concerning access, and the security level of the door environment, are made locally. The advantage of this is that even in the event of a communication breakdown, the system can still continue to function reliably. To be able to store a large number of events, cards and schedules, each ARX control unit has a large memory capacity.

Each door environment is connected to the ARX control unit via four wires. To ensure installation and to make it possible for all control units to be placed one room fitted with an alarm, the cable length between the control unit and the door control unit can be up to 500 meters. This also simplifies service and maintenance of the access system.

4. Door control unit

The door control unit (DAC) is a terminal block between the door's components and the control unit. Electric locks, door automation, card readers, exit buttons and alarm contacts can be connected in the DAC. One advantage of combining an ASSA motor lock with the ARX Access system is that they can utilize the same DAC, reducing the number of components in the door environment.

5. Readers

ASSA offers a large range of readers. They are designed to fit a variety of environments and the needs of different customers in terms of security and function. Proximity card readers are the most common today, since they offer high security in combination with convenience.



Easy management means better service

The software comprises a modern, user-friendly interface that can be easily adapted to the needs of different users. The most common functions, such as blocking or adding cards, changing access rights and reporting events, are self-explanatory and can be easily managed by the administrator.

You can also make subdivisions so that systems with more than one administrator can have different access to different parts of the information. This means that a building housing several companies can share a common access system, but subdivide it into parts dedicated to each company. Then each operator only has access to his/her part of the building.

Correct information immediately

An ARX Access system can be connected directly to the building's own computer network. When the administrator changes someone's access or blocks a card, all the doors receive this information immediately.

Geographic possibilities

The administrator can supervise/manage buildings with a wide geographical distribution. So an administrator at the company's head office can thus manage all the company's branch offices efficiently from the same place, saving both time and resources.

Being online creates options for more functions

The direct link between the administrator and the door environments also means that a door can be opened directly from the software. With additional partner systems, the intruder alarm can be turned on or off and CCTV images can be displayed in separate interfaces at other locations.

What happened and when?

All events in the door environment, such as valid access and unauthorised attempts at entry, are logged for quick and easy access. The administrator can search for individual events at a specific door or a specific person's activities in the building.



A security solution is most often demonstrated from the user's point of view, but it is just as important that the product and software are cost-effective to install, commission and maintain.

Smart products for both users and the installer. The ARX Access system's control units are plug and play. The units are selfconfiguring – they find their own place in the network when they are connected. They work completely independently and continue to control the door environments even if contact with the system server is lost. This means that the clever ARX system design reduces the risk of problems while simplifying commissioning the system.

Smart design solutions for software and hardware
The software is updated centrally in the system. No physical products need to be changed when new software or expansions are installed. Some readers can also easily be upgraded from stand alone to online readers and thus become part of the access system. Each door environment has an intelligent terminal block (DAC) to which the electric lock, reader, exit button and door monitor contact are connected. Since only four wires are needed (two for communication and two for power supply) between the door and the control unit, installation is easy and thus cost-effective.

Direct-controlled motor lock

An important advantage of the ARX Access control system is the option of integrated control through the ASSA motor lock's day and night function in the building. This function provides two alternatives: One is that the door opens immediately when the schedule for the setting "motor lock day/night" or the input "day/night" is activated. Another alternative is to allow the first valid entry to control the lock. This means that the motor lock switches to day settings with the first valid entry through the door.

A supplier you can trust

For installers, it's an advantage when one supplier can offer a complete system comprising everything from hinges to software for managing the system. We maintain a continuous dialogue with our dealers and distributors to help create better solutions. We can affect everything from the production of manuals to new communication standards for door environments. You can have full confidence in us as a partner that strives for continuous improvement.

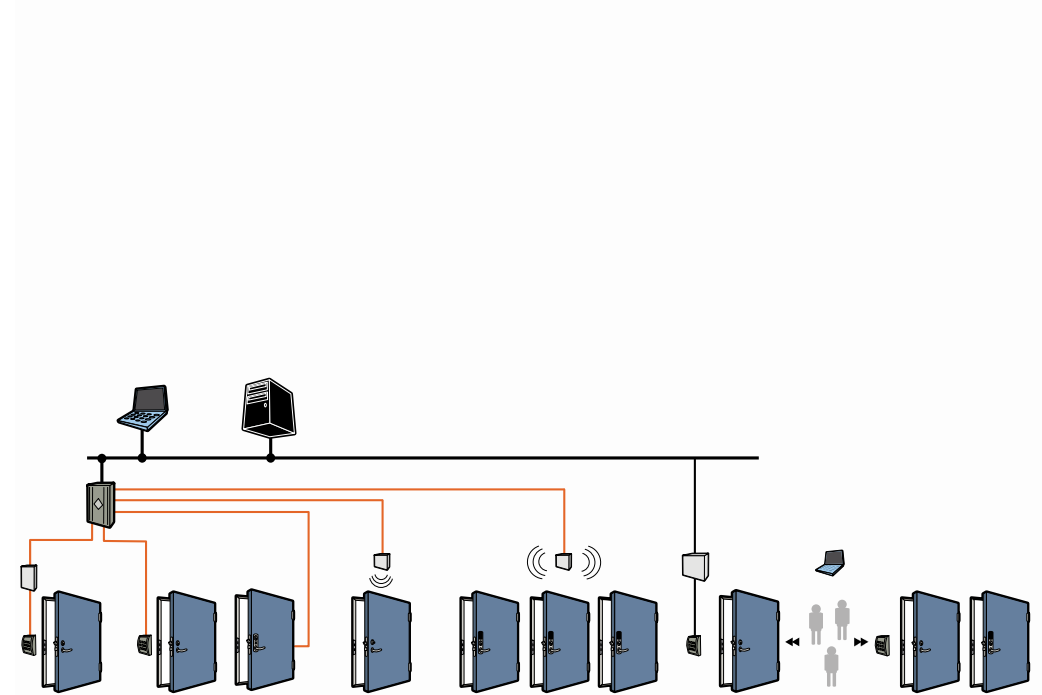

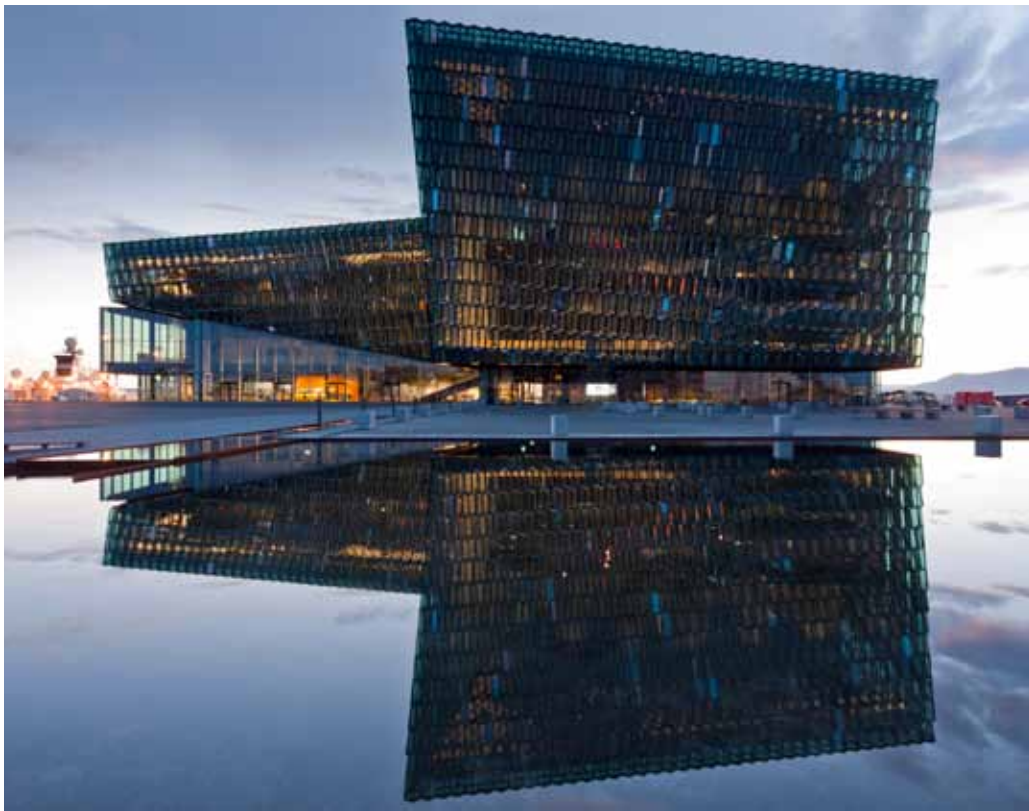

ACCESSORIES

ASSA offers the widest range of hardware in the market for secure, functional and decorative use. A large part of our fittings can be delivered in our nickel-free Prion® plating, which is suitable for allergy sufferers.

We have also launched a new plating named Addion®, which is not only nickel-free but also anti-bacterial. Addion is a unique metallic plating that combines effective decomposition of bacteria with a high degree of resistance to wear and tear. Consequently, Addion is perfect for environments in which bacteria spread easily, such as in healthcare, schools and childcare facilities, etc. We are sure you will find our range of accessories interesting.





Prion®

Application

For decorative use. Suitable for standard indoor and outdoor environments.

Finish

Nickel-free plating suitable for users with a contact allergy. The finish has strong resistance against wear and tear as well as corrosion.



Nickel

Application

For decorative use. Suitable for standard indoor and outdoor environments.

Finish

Bright surface with high resistance to wear and tear as well as corrosion.



Addion®

Application

For decorative use. Addion is ideal for use in environments in which bacteria spread easily, such as in healthcare, schools and childcare facilities, etc.

Finish

Addion is a unique nickel-free metallic plating that combines effective decomposition of bacteria with an excellent degree of resistance to wear and tear as well as corrosion.



This handle can be obtained with Addion - ASSA's antibacterial plating.

Polished chrome

Application

For decorative use. Suitable for indoor and outdoor environments, in which corrosion can appear.

Finish

Bright polished surface with excellent resistance to wear and tear as well as corrosion.



Satin chrome

Application

For decorative use. Suitable for indoor and outdoor environments, in which corrosion can appear.

Finish

Brushed surface with excellent resistance to wear and tear as well as corrosion.



Polished brass

Finish

Polished surface. Not recommended in environments subjected to sea air, because this will cause fittings to oxidize and turn black.

Application

For decorative use in indoor environments.



Satin brass

Application

For decorative use in indoor environments.

Finish

Brushed surface. Not recommended in environments subjected to sea air, because this will cause fittings to oxidize and turn black.



Brown anodised

Application

For decorative use in indoor environments.

Finish

Anodised surface with limited protection against wear and tear. Not recommended in environments subjected to sea air, because this will cause fittings to oxidize and turn black.



Stainless steel

Application

For decorative use in all environments.

Finish

Brushed surface. Very high resistance to wear and tear as well as corrosion.





Addion®—a unique antibacterial plating

ASSA already offers a large part of its fittings with the nickel-free surface treatment, Prion®. As a further step in our efforts to produce health-promoting surface treatments and in cooperation with Polygiene®, we are now launching a new product, Addion®.

Addion is a completely unique, metallic antibacterial surface treatment that combines Prion's nickel-free finish with effective decomposition of infectious bacteria and microorganisms as well as excellent durability. Consequently, Addion is ideal for environments in which bacteria spread easily, such as in healthcare, schools and childcare facilities.

Bacteria spread via contact surfaces

In the past few decades, cases involving bacteria that are resistant to common antibiotics have become a growing problem in healthcare worldwide. Clothes and hands are the largest disease carriers. Studies¹ show that multiresistant bacteria are often spread by surfaces that people frequently touch, such as door handles, light switches and IV stands.

ASSA's unique Addion surface treatment reduces the risk of bacteria spread by contributing to a more rapid decomposition of bacteria and microorganisms compared with other surface treatments. Naturally, Addion does not solve the problem of resistant bacteria on its own, but choosing fittings with the Addion surface treatment is a major step along the way.

A worldwide problem

For many years, healthcare services worldwide have increasingly had to deal with what we in everyday speech call hospital infections, some of which involve MRSA bacteria. This strain of bacteria has developed a greater resistance to penicillin, which makes it harder to treat and helps the bacteria spread more easily.

In addition, the costs involved in managing multi-resistant bacteria are huge for the society. This is due to longer hospital stays for patients, isolation of infected patients, more expensive medicine and more extensive hygienic measures.

In recent years, some fittings suppliers have developed powder coatings with antibacterial characteristics. Demand for door fittings with this type of coatings has since grown, primarily in the healthcare sector. The powder varnish contains silver ions; and silver has long been well known for its antibacterial characteristics.

The antibacterial powder coatings are a contributing



factor in combating the spread of multi-resistant bacteria.

However, powder coating has one disadvantage: poor resistance to wear and external mechanical damage. The antibacterial qualities of the coating are lost in places where the coating is worn or scratched.

Consequently, ASSA teamed up with Polygiene to work on creating a more durable surface treatment with equivalent characteristics. After extensive trials, we have succeeded in binding silver ions in a metallic surface treatment, which provides unsurpassed resistance to wear and tear. Addion's brushed surface allows for the largest possible amount of silver ions to be able to migrate (pass through) to the fitting's surface where they begin the decomposition process of bacteria and microorganisms. An illustration of how Polygiene's technique works is found on next page.

¹Importance of the environment in methicillin-resistant Staphylococcus aureus acquisition: the case for hospital cleaning. Dr Stephanie J Dancer MD. The Lancet Infectious Diseases 2008; 8:101-113



Decomposition of MRSA bacteria

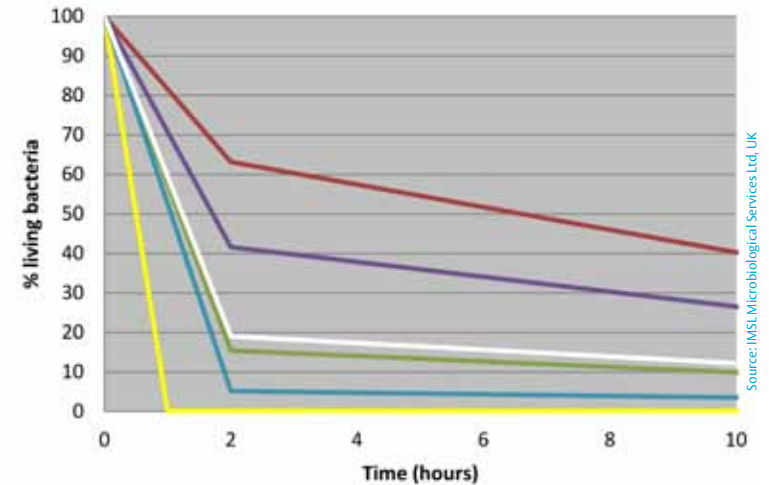
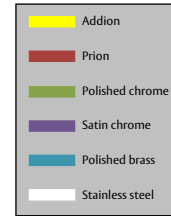

Source: IMSI/Microbiological Services Ltd, UK

Product information

- Addion is highly durable, comparable with chrome
- Addion is a nickel-free surface treatment
- The antibacterial effect is achieved by silver ions migrating to the surface, where the process of bacteria decomposition begins
- In terms of appearance, Addion looks like brushed stainless steel

Explanation of the graph:

- The antibacterial activity was tested based on JIS Z 2801:2000 (equivalent to ISO 22196).
- In order to be classified as antibacterial, the test method stipulates that the reduction of bacteria shall be equivalent or more than 1×10^2 within the period of 24 hours (i.e a concentration of 10 000 bacteria should be reduced to 100 bacteria within 24 hours)
- The antibacterial activity in Addion is clearly visible. After one hour all MRSA bacteria have been terminated. After two hours various concentrations of MRSA could still be measured on the other metallic surfaces.

Polygiene® technology - Inhibits the growth of microbes



The silver is homogeneously distributed throughout the material. Silver migrates to the surface. Silver ions kills the bacteria on the surface by penetrating the cell membrane

Addion is ideal for environments in which bacteria spread easily, such as in healthcare, schools and childcare facilities.





Sprung lever handles, Epok series

1918

This lever handle clearly shows influences from this period, although it is slightly heavier and the design is more distinct. The timeless elegance of the handle allows it to be used in practically any building, as long as the architecture is similarly elegant and timeless. Suitable for use in all modern-style houses with the exception of extremely functionalist ones.

Finish

Nickel, satin chrome, bright chrome, satin brass, polished brass, brown anodised or Prion.



1930

This lever handle is a sort of cross between two previously incompatible design periods. It combines the bud-like tubular handle of the 1880s and 1890s with the simple modernist handles of the 1930s. With a brass neck and black-and-white grip, the handle suits the style of the late 19th century. At the same time, its bright neck and black grip fit with 1930s functionalism and its modern successors. The combination of bright neck and white grip brings us to the 1940's, whereas simple bright or the combination bright/brass are more modern. Hence, the combination of colors and finishes make this handle suitable for many different periods.

Finish

Handle neck: nickel, satin chrome, bright chrome, satin brass, polished brass and Prion.
Grip: white (RAL 1013), black (RAL 8022) or green (RAL 6028) powder lacquer or nickel-plated, satin chrome, bright chrome, satin brass, polished brass or Prion.



Sprung lever handles, Epok series

1956



This lever handle has a funny history: they say the designer simply squeezed a clump of clay, without even looking, until it felt right. The handle in production today has essentially the same shape as that clay model.

The model bears a clear resemblance to ASSA lever handle 696, and the heritage of the 1950s design is evident. To achieve a more modern design, the shapes of the handle have been somewhat exaggerated. This handle is well suited for all architectural trends of the 1950s and onwards.

Finish

Nickel, satin chrome, bright chrome, satin brass, polished brass, brown anodised, Prion or Addition.





Unsprung lever handles, Epok series

1905

This lever handle was inspired by the most common Art Noveau handles, but it is slightly heavier and more distinct. It is ideal for use in interior doors.

Finish

Nickel, satin chrome, bright chrome, satin brass, polished brass, brown anodised or Prion.



1923

This lever handle reflects the Nordic Classicist style of the 1920s. With its rounded spoon shape, it suits both interior and exterior doors.

Finish

Nickel, satin chrome, bright chrome, satin brass, polished brass, brown anodised or Prion.



Unsprung lever handles, Epok series

1935

A beautifully shaped lever handle that has become a favorite of many. The clear, straightforward design refers to the period when the streamline form became popular.

Finish

Nickel, satin chrome, bright chrome, satin brass, polished brass, brown anodised or Prion.



1949

Many people recognize this lever handle model as the classic ASSA handle. This particular model is slightly lighter and has a diamond-shaped grip that fits the hand well. Suitable for both interior and exterior doors.

Finish

Nickel, satin chrome, bright chrome, satin brass, polished brass, brown anodised or Prion.





Sprung lever handles, Epok series

1903

The Wright brothers pilot an aircraft for a total of 12 seconds, traveling a total length of 37 meters. The first transatlantic radio broadcast takes place between England and the United States. The first Tour de France is raced.

Finish

Nickel, satin chrome, bright chrome, satin brass, polished brass and brown anodised.



1927

The first VOLVO car is produced and sold, with a price tag of SEK 4,800 (about EUR 520 at present-day exchange rates). The first successful long-distance demonstration on television occurs. The Ford Motor Company ceases manufacturing its Model T.

Finish

Nickel, satin chrome, bright chrome, satin brass, polished brass and brown anodised.



Sprung lever handles, Epok series

1937

Bruno Mathsson, famous Swedish architect, receives an award at the world exhibit in Paris. Walt Disney's *Snow White and the Seven Dwarfs* premieres, and quickly becomes a smash hit. Morgan Freeman is born.

Finish

Nickel, satin chrome, bright chrome, satin brass, polished brass and brown anodised.





Sprung lever handle, Classic

Arena U



Arena U is a robust lever equipped with both return-spring and needle layer. It has been designed for heavy-duty use in environments such as hospitals and public arenas. You open the door using your hand or, if your hands are full, your elbow.

Features

- Material: Brass
- Finish: nickel, satin chrome, bright chrome, polished brass, Prion or Addion
- Through-bolt fixing for added strength
- Standard delivery for 40–57 mm or 58–75 mm door thickness
- Rose: 52 mm Ø
- The two handle halves are linked by a replaceable square spindle and screws of different lengths for different door thicknesses



Arena U, matt krom

6640



A classic lever handle from the 1950s and 1960s that is still very popular. A great design that will last for many years to come and is suitable for a great range of environments.

Features

- Material: Brass
- Finish: nickel, satin chrome, bright chrome, satin brass, polished brass, brown anodised, Prion or Addion
- Built-in return spring that supplements the handle follower spring in the lock case and helps keep the handle in a horizontal position
- Through-bolt fixing for added strength
- Standard delivery for 40–57 mm or 58–75 mm door thickness
- Rose: 52 mm Ø
- The two handle halves are linked by a replaceable square spindle and screws of different lengths for different door thicknesses



Satin brass



Prion



Polished brass



Brown anodised



Sprung lever handle, Classic

6696



This is another classic ASSA lever handle from the 1950s and 1960s. The handle has a discreet, thorough design. Function is important, but not at the expense of attention to human aspects. This makes it timeless and suited to all applications.

Features

- Material: Brass
- Finish: nickel, satin chrome, bright chrome, satin brass, polished brass, brown anodised, Prion or Addion
- Built-in return spring that supplements the handle follower spring in the lock case and helps keep the handle in a horizontal position
- Through-bolt fixing for added strength
- Standard delivery for 40–57 mm or 58–75 mm door thickness
- Rose: 52 mm Ø
- Two lever handle halves are linked by a replaceable square spindle and screws available in different lengths for different door thicknesses



Satin brass



Nickel



Polished brass



Brown anodised

6616



This lever handle represents our most minimalistic design. It is a very simple, modern handle ideal for buildings with a plain decor, such as hospitals and institutions.

Features

- Material: Brass
- Finish: Nickel, satin chrome, bright chrome, satin brass, polished brass, brown anodised, Prion or Addion
- Built-in return spring that supplements the handle follower spring in the lock case and helps keep the handle in a horizontal position
- Through-bolt fixing for added strength
- Rose: 52 mm Ø
- Handle: 16 mm Ø
- The two handle halves are linked by a replaceable square spindle and screws of different lengths for different door thicknesses



Polished chrome



Polished brass



Satin chrome



Sprung lever handle, Classic

6647

This lever handle was designed by Carl Arne Breger in the 1970s and reflects the rational and slightly square-shaped design that characterises that time. With its discreet but distinguished design the handle is a modern-day classic.

Features

- Material: Brass
- Finish: Nickel, satin chrome, bright chrome, satin brass, polished brass, brown anodised or Prion
- Built-in return spring that supplements the handle follower spring in the lock case and helps keep the handle in a horizontal position
- Through-bolt fixing for added strength
- Standard delivery for 40-57 mm or 58-75 mm door thickness
- Rose: 52 mm Ø
- The two handle halves are linked by a replaceable square spindle and screws of different lengths for different door thicknesses



Satin brass



Polished chrome



Polished brass



Brown anodised

6655



This U-shaped lever handle has a minimalistic design. Ideal for buildings with a plain decor, such as hospitals and institutions.

Features

- Material: Brass
- Finish: Nickel, satin chrome, bright chrome, satin brass, polished brass, Prion or Addion
- Built-in return spring that supplements the handle follower spring in the lock case and helps keep the handle in a horizontal position
- Through-bolt fixing for added strength
- Rose: 52 mm Ø
- Handle: 16 mm Ø
- The two handle halves are linked by a replaceable square spindle and screws of different lengths for different door thicknesses
- The design complies with british DDA standard.
- Cover cap for concealed screw attachment is available



Satin chrome



Satin chrome with cover cap



Sprung lever handle, Classic

6638

The design of this lever handle reflects both the baroque and rococo styles, yet in a simpler manner to suit architecture with less curved forms.

Features

- Material: Brass
- Finish: nickel, satin chrome, bright chrome, satin brass, polished brass, brown anodised or Prion
- Built-in return spring that supplements the handle follower spring in the lock case and helps keep the handle in a horizontal position
- Through-bolt fixing for added strength
- Standard delivery for 40-57 mm or 58-75 mm door thickness
- Rose: 52 mm Ø
- The two handle halves are linked by a replaceable square spindle and screws of different lengths for different door thicknesses



Satin brass



Nickel



Polished brass



Brown anodised



Unsprung lever handles, Classic

640



The classic ASSA lever handle from the 1950s and 1960s in its original design. The handle is well-known and features thorough and careful design.

Features

- Material: Brass
- Finish: Nickel-plated, satin chrome, bright chrome, satin brass, polished brass, brown anodised, Prion or Addion
- Through-bolt fixing for added strength
- Standard delivery for 40–57 mm or 58–75 mm door thickness
- Rose: 52 mm Ø
- The two handle halves are linked by a replaceable square spindle and screws of different lengths for different door thicknesses
- Available with DIN rose 38 mm centre between lever screw holes
- Cover cap for concealed screw attachment is available

The ASSA 640 and ASSA 696 are also available for DIN-standard lock cases.

696



The classic ASSA lever handle from the 1950s and 1960s in its original design. The handle is well-known and features thorough and careful design.

Features

- Material: Brass
- Finish: Nickel-plated, satin chrome, bright chrome, satin brass, polished brass, brown anodised, Prion or Addion
- Through-bolt fixing for added strength
- Standard delivery for 40–57 mm or 58–75 mm door thickness
- Rose: 52 mm Ø
- The two handle halves are linked by a replaceable square spindle and screws of different lengths for different door thicknesses
- Available with DIN rose 38 mm centre between lever screw holes



Satin brass

Prion

Polished brass

Brown anodised

Cover cap for concealed screw attachment. Fits with ASSA lever 640, 696 and 6655

Nickel

Brown anodised

Polished brass



Unsprung lever handles, Classic

5602

This is a very simple and elegant brass handle. It was primarily designed for use in light interior doors within the residential sector, where elegance and a traditional touch are sought at a reasonable cost.

Features

- Material: Brass
- Finish: Nickel, bright chrome, satin brass, polished brass or brown anodised
- Standard delivery for 36–52 mm door thickness.
- Through-bolt fixing
- The two handle halves are linked by a replaceable square spindle and screws of different lengths for different door thicknesses

5614

This is a simplified handle. The discreet design does not draw attention to itself and therefore suits practically any environment.

Features

- Material: Zinc
- Finish: Bright chrome
- Through-bolt fixing with two screws and hardened nipples
- For 40 mm door thickness
- Screws: 4 mm Ø
- The two handle halves are linked by a square spindle
- For use in light interior doors within the residential sector

Cylinder accessories for ASSA Euro profile cylinders

18 256 DIN



Application

Cylinder accessories for interior and exterior locking.

Features

- Material: Brass
- Finish: Polished brass, chrome, satin chrome and Addion
- Fits double euro-profile cylinders
- Available in several decorative finishes

Function

The cylinder ring gives a decorative look and helps prevent damage to the cylinder.



Satin brass

Prion

Brown anodised

Polished chrome



18 256 DIN



Unsprung lever handle, Villa series

ASSA presents a new designed range of lever handles and accessories for the DIY segment. All lever handles are made out of hard forged solid brass and available in a range of surface treatments. Delivered in an exclusive DIY pack, the Villa series is compatible with lock cases as ASSA Modular, ASSA Connect and Boda interior locks.

- Scandinavian standard rose – 30 mm between the fixing screws.
- Suitable for door thicknesses of 35–65 mm.
- 8 x 8 spindles and M4 through-going screws and nipples are enclosed in each set.
- Key escutcheons and toilet indicators in the same design as the handles.

Finish

- 14090 Bright chrome, satin chrome
- 14010 Bright chrome, satin chrome
- 14180 Bright chrome, satin chrome

ASSA presents a new designed range of lever handles and accessories for the DIY segment. All lever handles are made out of hard forged solid brass and are available in a range of surface treatments. Delivered in an exclusive DIY pack, the Villa series is compatible with lock cases such as the ASSA Modular, ASSA Connect and Boda interior locks.

- Scandinavian standard rose – 30 mm between the fixing screws.
- Suitable for door thicknesses of 35–65 mm.
- 8 x 8 spindles and M4 through-going screws and nipples are enclosed in each set.
- Key escutcheons and toilet indicators in the same design as the handles.

Finish

- 14110 Satin chrome, bright chrome
- 14020 Satin chrome, bright chrome



14090 - Satin chrome



14010 - Satin chrome



14180 - Satin chrome



14110 - Satin chrome



14110 - Bright chrome



14020 - Satin chrome



14020 - Bright chrome



Unsprung lever handle, Villa series

ASSA presents a new designed range of lever handles and accessories for the DIY segment. All lever handles are made out of hard forged solid brass and available in a range of surface finishes. Delivered in an exclusive DIY pack, the Villa series is compatible with lock cases such as the ASSA Modular, ASSA Connect and Boda interior locks.

- Scandinavian standard rose – 30 mm between the fixing screws.
- The lever handles is suitable for door thicknesses between 35-65 mm.
- 8 x 8 spindles and M4 through-going screws and nipples are enclosed in each set.
- Key escutcheons and toilet indicators in the same design as the handles.

Finish

- 14160 Polished brass, satin chrome, bright chrome



14160 - Satin chrome



14160 - Bright chrome



Unsprung lever handle, Villa series

ASSA presents a new designed range of lever handles and accessories for the DIY segment. All lever handles are made out of hard forged solid brass and available in a range of surface finishes. Delivered in an exclusive DIY pack, the Villa series is compatible with lock cases such as the ASSA Modular, ASSA Connect and Boda interior locks.

- Scandinavian standard rose – 30 mm between the fixing screws.
- Suitable for door thicknesses of 35–65 mm.
- 8 x 8 spindles and M4 through-going screws and nipples are enclosed in each set.
- Key escutcheons are included in each set.
- Toilet accessory 14890 are available in the same design.

Finish

- 14070 Satin chrome
- 14140 Bright chrome, satin chrome
- 14200 Bright chrome, satin chrome
- 14130 Bright chrome, satin chrome



Toilet accessories, Villa series, 14890

Application

Toilet indicator 14890 is a toilet accessory in the Villa series intended for interior door locks FAS 2020, ABLOY 2014 and FAS 40T in the residential sector.

Features

- Material: Brass
- Finish: Bright chrome, satin chrome and polished brass
- Rose: 52 mm Ø
- Red/white indication on the inside and outside
- Through-bolt fixing with two screws M4 Ø and fixed nipples

Function

- Inside thumbturn
- Can be opened from the outside with a screwdriver



14890 - Bright chrome



Cover cap in stainless steel for concealed screw attachment.

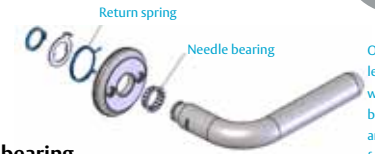

Our stainless steel levers are equipped with stainless needle bearings for smooth and almost friction free movement.

Sprung lever handle with needle bearing, stainless steel

8650, 8665, 8670, 8680, 8685, 8690

Application

Our stainless steel lever handles, pull handles and accessories are ideal for modern public areas such as institutions and offices. The stainless steel material is highly resistant to corrosion and severe air pollutants, and is recommended for use in environments with stringent hygienic requirements. Thumbturns, toilet and cylinder accessories are available in the same design series to complement the ASSA stainless steel lever handles.

Features

- Finish: Satin-brushed stainless steel AISI 316L
- Standard rose with return spring that supplements the handle follower spring in the lock case and helps the handle return to horizontal position
- Through-bolt fixing with 5 mm Ø screws and nipples for greater strength
- The two handle halves are linked by a replaceable square spindle and screws in various lengths for different door thicknesses
- Available with an independent clip-on rose for hidden screw attachment (Model 8680 and 8690 excluded)
- Standard rose: 53 mm Ø and clip-on rose 55 mm Ø

Unsprung lever handle with needle bearing, stainless steel

865, 866, 867

Application

Our stainless steel lever handles, pull handles and accessories are ideal for modern public areas such as institutions and offices. The stainless steel material is highly resistant to corrosion and severe air pollutants, and is recommended for use in environments with stringent hygienic requirements. Thumbturns, toilet and cylinder accessories are available in the same design series to complement the ASSA stainless steel lever handles.

Features

- Finish: Satin-brushed stainless steel AISI 316L
- Through-bolt fixing with 5 mm Ø screws and nipples for greater strength
- The two handle halves are linked by a replaceable square spindle and screws in various lengths for different door thicknesses
- Available with an independent cover cap concealed screw attachment (Model 8680, 8690, 8641, 8642, 8643, 8644 excluded)
- Standard rose: 53 mm Ø and clip-on rose 55 mm Ø

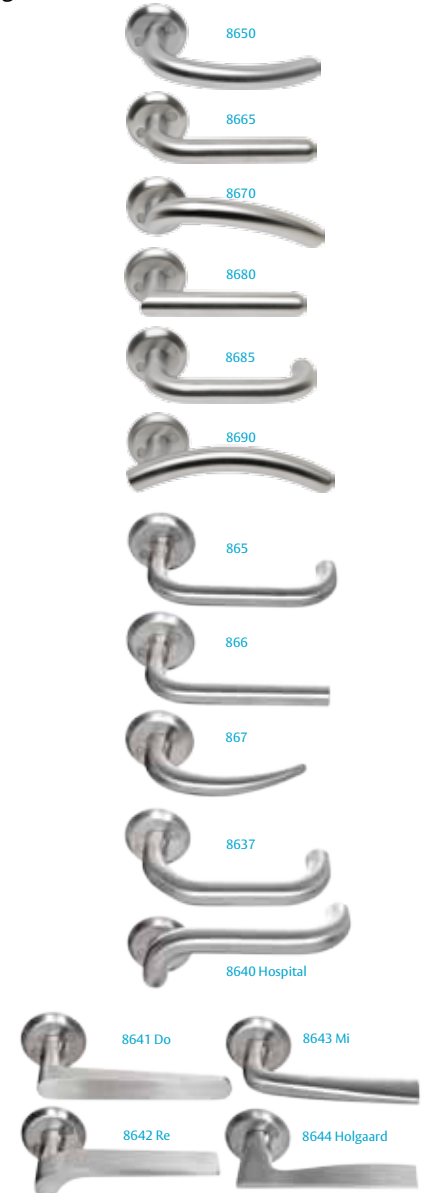



ASSA ABLOY Code Handle Door, electromechanical code handle for innerdoors



8812

Application

For easy and convenient locking/unlocking of interior door. E.g. Office doors, staffrooms, archives, back office, store applications.

Features

- "Access Filtering"
- Easy locking without keys
- No wiring
- Master code and up to 9 user codes.
- Blocking function if wrong code is entered five times
- Auto or manual locking
- "Simplicity creates security"

Function

- Indoor use only
- Fits lock cases with DIN, ANSI and other relevant standards
- Two CR2, 3V lithium batteries tested, (for approx 60 000 operations)
- 4-6 digit code
- Material: brushed stainless steel and satin chrome zinc
- Indication for battery change
- Tested to at least 100 000 operations, according to EN 1906
- Fire tested according to EN 1363



ASSA ABLOY Code Handle Door, electromechanical code handle for innerdoors



8812 for European DIN standard
8810 and 8811 for Scandinavian standard
8814 for ABLOY lock cases
8815 for Japan
8816 for ANSI Standard North America
8818 For Spain (8812 rose with 45°)
Also available in Long Plate versions.

Model example 8812

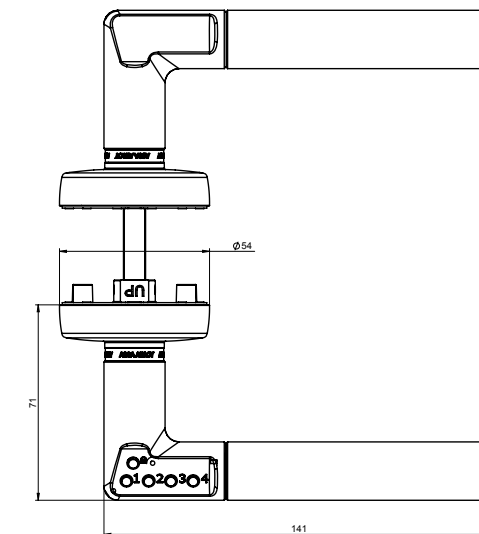

Distance ring 8820 (accessory)

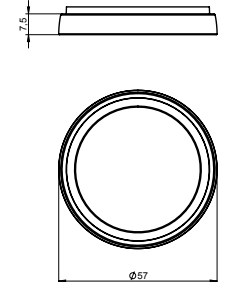

For drawings of 8810, 8814, 8815, 8816, 8817 and 8818, please see our homepage www.assaom.se.

Number	Description	Adopted for locks	Non coded model
8812-7	Code Handle	DIN Standard 7mm sprint (FR)	8802-7
8812-8	Code Handle	DIN Standard 8mm sprint (EU)	8802-8
8814	Code Handle	ABLOY lock cases (9456 etc.)	8804
8815	Code Handle	JAPAN	
8816	Code Handle	ANSI version for North America (8mm spindle)	8806
8818	Code Handle	Same as 8812 but turned rose 45°	
8810	Code Handle	Scandinavia Modul, Evo, Connect	8801
8811	Code Handle	Scandinavian residential 2014	8803
8820	Distance ring		
8821	Battery hatch incl. spring		

All variants is supplied in right or left handle version.
Also in Long Plate Versions, see separate leaflet.



ASSA ABLOY Code Handle Door Long Plate, electromechanical code handle for doors



Application

For easy and convenient locking/unlocking of interior door. E.g. Office doors, staffrooms, archives, back office, store applications.

Features

- "Access Filtering"
- Easy locking without keys
- Easy to fit, no cables
- No wiring
- Master code and up to 9 user codes
- Blocking function if wrong code is entered five times
- Auto or manual locking
- "Simplicity creates security"
- With or without Euro cylinder option

Function

- Indoor use only
- Fit most lock cases
- Two CR2, 3V lithium batteries in the outer handle, (approx 60 000 operations)
- 4-6 digit code
- Material: brushed stainless steel and satin chrome zinc
- Indication for battery change
- Tested to at least 100 000 operations, according to EN 1906
- Fire tested according to EN 1363



ASSA ABLOY Code Handle Door Long Plate, electromechanical code handle for doors

- 8830 Long Plate, 7/8 mm spindle, No hole
- 8831 Long Plate, 7 mm spindle 70 mm to hole
- 8832 Long Plate, 8 mm spindle 72 mm
- 8833 Long Plate, 8 mm spindle 85 mm
- 8834 Long Plate, 8 mm spindle 55 mm

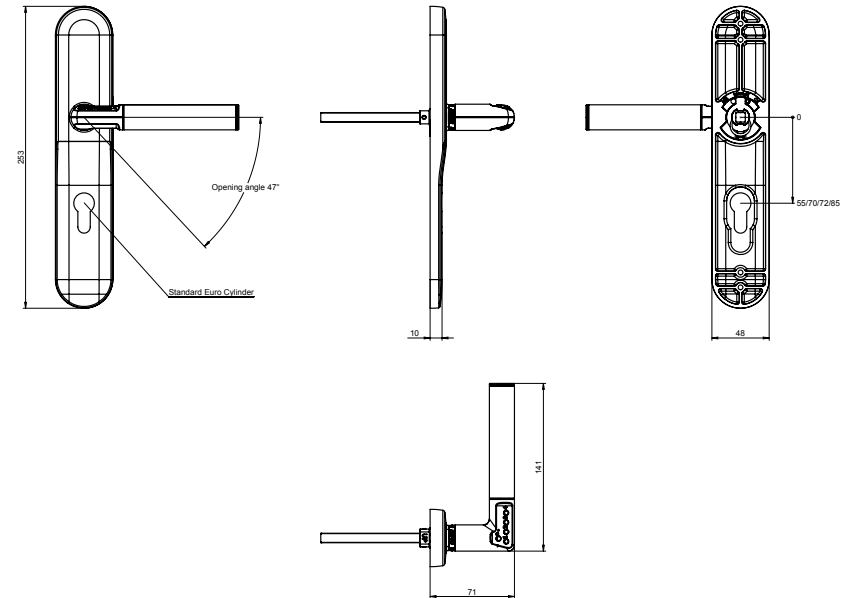

Number	Description	Adopted for locks	Spindle/Keyhole
8830-8	Code Handle Long Plate 8 mm spindle W/O hole	EU	N/A
8830-7	Code Handle Long Plate 7 mm spindle W/O hole	FR	N/A
8831	Code Handle Long Plate 7 mm spindle 70 mm to cylinder centre	FR	70 mm
8832	Code Handle Long Plate 8 mm spindle 72 mm to cylinder centre	EU	72 mm
8833	Code Handle Long Plate 8 mm spindle 85 mm to cylinder centre	EU	85 mm
8834	Code Handle Long Plate 8 mm spindle 55 mm to cylinder centre	NL(EU)	55 mm
8821	Battery hatch incl. spring		

All variants is supplied in a right or left handle version. All variants can be delivered as a version W/O code. Code Handle is also available in several Rose versions.



Pull and turn knobs

Turn knob

167

Application

For doors and hatches.

Features

- Material: Brass
- Finish: nickel, satin chrome, bright chrome, satin brass, polished brass, brown anodised or Prion
- Knob: 50 mm Ø
- Rose: 52 mm Ø

Function

- The two knobs are linked by a replaceable square spindle for various door thicknesses
- Can be combined with ASSA modular locks



Nickel

Pull knob

496

Application

For doors and hatches.

Features

- Material: Brass
- Finish: nickel, satin chrome, bright chrome, satin brass, polished brass, brown anodised or Prion
- Knob: 50 mm Ø
- Rose: 52 mm Ø

Function

- Non-turnable pull knob



Nickel

Espagnolette handles



7801, 7802, 7811, 7812, 7902, 7912

Application

For mounting on the inside of French doors and windows with espagnolettes. Suitable for all types of buildings. Also recommended for use in cabinet and closet doors, electric cabinets etc. with alternative espagnolettes.

Features

- The handle is available in four versions:
 - Curved, right or left
 - Straight, right or left
- The lock case and handle are made of zinc
- Finish: Bright chrome or satin chrome

Function

- Has a cylinder that blocks the turning of the handle when locked
- Lockable espagnolette handle for interior mounting on a French door or a window. Complemented with an oval ASSA cylinder.

- 7801 Right or left straight handle, key removable in locked position
- 7802 Right or left straight handle, key removable in locked or unlocked position
- 7811 Right or left curved handle, key removable in locked position
- 7812 Right or left curved handle, key removable in locked or unlocked position

Lockable espagnolette handle for interior mounting on a French door or a window. Complemented with an oval ASSA cylinder.

- 7902 Right or left straight handle, key removable in locked or unlocked position
- 7912 Right or left curved handle, key removable in locked or unlocked position

Outside handle

- 17911 Handle, non-lockable, right
- 17912 Handle, non-lockable, left

Recommended accessories

- 833 Handle coupling. Used when handles are to be fitted on both sides in a single frame
- 961 Handle coupling. Used when handles are to be fitted on both sides in a dual frame

Comment

These specifications must be included in all orders:

1. Curved right or left handle or straight right or left handle
2. 8 mm square steel spindle, 53 mm or 93 mm length



7802, left

7802, straight

7802, right



17911/17912



Pull handles, single

Pull handle 417-M 10

Application

Facilitates the closing of doors in public environments, for example toilet doors.

Features

- Fixed mounting, doesn't affect handle or lock
- Mounted horizontally on the door as pictured
- Delivered in parts, which enables adaptation to right or left door
- The pull handle can be shortened to suit narrower doors than the Modular 10
- Finish: Polished stainless steel

Function

A complete handle package includes:

- 1 polished stainless steel pull handle with a length suitable for a Modular 10 door
- 2 fittings of die-cast aluminium (silumin), black epoxy painted
- 1 screw for attaching the holder to be mounted under the clip-on rose



Pull handle 417-M 10

130, 131

Application

A simple pull handle for cabinets, sliding doors etc.

Features

- Material: Brass
- Finish: Bright chrome, polished brass, Prion or Addion
- Attached with wood screws
- Through-bolt fixing is available for door thicknesses 34–62 mm and 60–82 mm



130

131

Pull handles, stainless steel



8630, 8631

Application

Simple, smooth pull handles that are recommended for rough environments such as public places and institutions. The stainless steel material is highly resistant to corrosion and severe air pollutants and is recommended for use in environments with stringent hygienic requirements.

Features

- All visible parts made of stainless steel
- Finish: Satin stainless steel
- Concealed fixing
- Available in single or double model with through-bolt fixing

Catalog no.	Tube Ø mm	Length c/c mm
8630-25/300	25	300
8630-31/300	31	300
8630-31/400	31	400
8630-38/300	38	300
8630-38/400	38	400
8631-25/300	25	300
8631-31/300	31	300
8631-31/400	31	400
8631-38/300	38	300
8631-38/400	38	400



8630



8631



137, 138



Application

Two beautiful pull handles with a classic design. Their simplicity and harmonious appearance is perfect for modern and older select doors. They have the same style as ASSA lever handle 6616.

Features

- Material: Brass
- Finish: Polished brass, bright chrome, Prion or Addion
- Available in single or double model with through-bolt fixing
- Pull handle 137: Available in four lengths: 160 mm, 250 mm and 400 mm
- Pull handle 138: Available in three lengths: 160 mm, 250 mm and 400 mm
- Door thickness should be 8-80 mm for length 160 mm and 8-95 mm for lengths 250 mm and 400 mm
- Support bracket 039 is recommended for wooden doors
- A special fitting set is used for fixing in glass doors



137



138

325, 326



Application

Two beautiful curved pull handles with ifunctionalist influences. Their simple design suits nearly any door.

Features

- Material: Brass
- Finish: Polished brass, bright chrome, Prion or Addion
- Available in single or double model with through-bolt fixing
- Support bracket 039 is recommended for wooden doors
- For door thickness 25-110 mm
- Available in two lengths: 250 mm and 300 mm
- A special fitting set is used for fixing in glass doors



325



326



Thumb turn 560 Override

Application

ASSA's treatment room fittings are designed to meet the need for privacy and personal safety for patients in various kinds of institutional settings, such as environments in psychiatry and correctional rehabilitation.

Features

- For patient rooms and treatment rooms where the option of locking is deemed desirable, though staff must be able to easily enter at any time.
- The knob disengages when attempts to resist entry are made from inside.

Handle ASSA Flip-down

Application

ASSA's treatment room fittings are designed to meet the need for privacy and personal safety for patients in various kinds of institutional settings, such as environments in psychiatry and correctional rehabilitation.

Features

- The conical shape of the handle makes it difficult to use rope or cord to get a grip
- When a load is applied the handle folds down, thereby reducing the potential for personal injury
- When combined with the ASSA 565 lock case, personnel are always able to enter using a key, even if the user tries to resist entry from inside

Other hardware

- These products are suitable for use together with the ASSA 565 lock case
- When integrated with an access system, lock case 560, 562 or 1560 is recommended





Lever handle dimensions

Dimensions (mm)					
Model	L (mm)	U (mm)	Diameter	Needle	Equipped with return spring
Epok series					
1903	137	75			x
1905					
1918	114	79			x
1923					
1927	118	77			x
1930	130	62			x
1935					
1937	130	66			x
1949					
1956	111	69			x
Classic series					
6640	110	55			x
6696	106	55			x
6655	140	64	19		x
6638	121	60			x
6616	129	58	18		x
6647	120	57			x
640	110	55			
696	106	55			
5602	108	46			
5614	115	48			
Villa series					
14010	118	70			
14020	112	50			
14070	106	52			
14090	120	52			

Model	L (mm)	U (mm)	Diameter	Needle	Equipped with return spring
Villa series					
14110	117	58			
14140	121	53			
14160	131	56			
14180	118	49			
14200	102	57			
14240	125	60	16		
14250	114	42,5			
Stainless steel series					
865	140	71	16	x	
866	130	71	16	x	
867	120	58		x	
8650	137	80	19	x	x
8665	135	77	19	x	x
8670	142	87	19	x	x
8680	130	65	19	x	x
8685	144	80	19	x	x
8690	164	70	19	x	x
8637	142	89	19	x	x
8638	130	70	19	x	x
8639	145	70	19	x	x
8640 Hospital	155	70	19	x	x
8641 DO	142	70		x	x
8642 RE	135	75		x	x
8643 MI	133	75		x	x
8644 Holgaard	134	60		x	x
Arena					
Arena U	152	76		x	x



Pull handle dimensions

Dimensions (mm)			
Model	CC (mm)	U (mm)	Diameter
8630	300	80	25
	300	85	31
	300	100	38
	400	85	31
	400	100	38
8631	300	85	25
	300	90	31
	300	100	38
	400	90	31
	400	100	38
130	92	50	8
	138	60	12
	188	65	12
131	138	56	12
	188	58	12
137	160	60	16
	250	77	20
	400	77	20
138	160	60	16
	250	77	20
	400	77	20
325	250	87	25
326	300	92	30
417		67	19
	400	90	30



Cylinder accessories for oval cylinders 256, 2256, 2256 RC, 2356, 9256, 18256

Application

Cylinder accessories for interior and exterior locking.

Features

- Material: Brass
- Fits ASSA oval single cylinders
- Available in several decorative finishes
- Thumbturn rose is available in the Epok series
- Height of the cylinder ring and length of the screws and thumbturn follower are chosen according to the door thickness
- The 9256 is available with thumbturn adjusted for easier opening and can be fixed on lock cases with 90° thumbturn rotation
- The 256 is available with a microswitch for opening indication
- The 18256 can be mounted using one-way screws

Function

- Thumbturn for operating bolt and/or latch
- The cylinder ring helps prevent damage to the cylinder

- 256/256E: Accessories for single cylinder and thumbturn. 256E thumbturn from Epok series.
- 2256: Accessory for cylinder on the inside and cover plate on the outside.
- 2356: Accessory for cylinder on the outside and cover plate on the inside.
- 9256: Accessory for single cylinder and extended thumbturn for the disabled.
- 18256: Accessory for oval double cylinder.



Double cylinder locks

Accessory sets 5761-1 and 5761-3 for double cylinder lock

Application

This is an accessory set that permits opening through two independent cylinders. Suitable in cases when two lock systems or cylinder models must be able to open the same lock.

Features

- Fits lock case ASSA 5761
- Fits all oval cylinders in the ASSA range
- Available with electric strike
- Accessory set 5761-1 contains a cylinder accessory with a special adapter for external lever handle position and an external pull handle. Must be supplemented with an inside handle-half and cylinder accessory 2356 for the cylinder position.
- Accessory set 5761-3 contains a double-sided cylinder accessory with a special adapter for external lever handle position and an external dual pull handle.
- Must be supplemented with cylinder accessory 18256 for the cylinder position.

Function

- Accessory set 5761-1: A key through one of the two external cylinders opens the latch bolt of the lock case. From the inside it is opened by the lever handle.
- Accessory set 5761-3: A key through one of the two external cylinders opens the latch bolt of the lock case from both the inside and the outside.



5761-1



5761-3



Cylinder accessories for oval cylinders–stainless steel

ASSA stainless steel lever handles, pull handles and accessories are ideal for modern public areas such as institutions and offices. The stainless steel material is resistant to corrosion and strong air pollutants and is recommended for use in environments with stringent hygienic requirements.

8256RF, 2256RF, 2356RF

Application
Cylinder accessories for interior and exterior locking.

- Features**
- Fits ASSA oval single cylinders
 - All visible parts made of satin brushed stainless steel
 - The height of the cylinder ring and length of the screws and thumbturn follower are chosen according to door thickness

- Function**
- Thumbturn for operating bolt and/or latch
 - The cylinder ring helps prevent damage to the cylinder.
 - 8256 RF: Accessory for single cylinder and thumbturn
 - 2256 RF: Accessory for cylinder on the inside and blind rose on the outside
 - 2356 RF: Accessory for cylinder on the outside and blind rose on the inside

18 256RF

Application
Cylinder accessory for interior and exterior locking.

- Features**
- Fits ASSA oval double cylinders
 - All visible parts made of satin brushed stainless steel
 - The height of the cylinder ring and length of the screws and thumbturn follower are chosen according to door thickness
 - Can be fitted with one-way screws to prevent unauthorized dismantling

- Function**
- The cylinder ring helps prevent damage to the cylinder.
 - 18256 RF: Accessory for oval double cylinder



8256RF



2256RF



2356RF



18256RF



Cylinder accessories for round cylinders

Cylinder accessories 3212



Application
For perimeter protection and other important doors.

- Features**
- Fits ASSA round double cylinders
 - Available in several decorative finishes
 - The accessory set (screws and, if necessary, cylinder extensions) is chosen according to the door thickness

- Function**
- Decorative cylinder accessories.
 - 3212: Accessory for round double cylinder



3212

Round thumbturn cylinder 3211

Application
Accessory set with thumbturn function for round cylinders.

- Features**
- Fits ASSA round single cylinders
 - Available in several decorative finishes
 - The accessory set (screws and, if necessary, cylinder extensions) is chosen according to the door thickness
 - Built-in, magnetic return mechanism for automatic, smooth return to initial thumbturn position

- Function**
- Cylinder accessories with thumbturn function for decorative fitting.
 - 3211: Accessory for round single cylinder and thumbturn



3211



Round blind cylinder 3212B

Application

Accessory set with a round blind cylinder for perimeter protection and other important doors where key access is desired from the inside only.

Features

- Material: Brass
- Fits ASSA inside round cylinders
- The accessory set includes a drill/vandalism proof round blind cylinder to be fitted on the outside of the door, plus decorative cylinder accessories
- Blind outside cylinder sleeve
- Available in several decorative finishes
- The accessory set (screws and, if necessary, cylinder extensions) is chosen according to the door thickness

Function

- Cylinder accessories for decorative fitting with key function on the inside only
- Cannot be opened from the outside
- 3212B: Accessory for round single cylinder and round blind cylinder



3212B



Cylinder accessories for ASSA round cylinders

Cylinder accessory 3212 RF

Application

For perimeter protection and for other important doors.

Features

- Fits ASSA round double cylinders
- All visible parts made of satin brushed stainless steel
- The accessory set (screws and, if necessary, cylinder extensions) is chosen according to the door thickness

Function

- Cylinder accessory for decorative fitting.
- 3212RF: Accessory for round double cylinder



3212RF

Round thumbturn cylinder 3211RF

Application

Accessory set with thumbturn function for round cylinder.

Features

- Fits ASSA round single cylinders
- All visible parts made of satin brushed stainless steel
- The accessory set (screws and, if necessary, cylinder-extensions) is chosen according to the door thickness

Function

- Decorative cylinder accessory with thumbturn function.
- 3211RF: Accessory for round single cylinder and thumbturn function



3211RF



**Opening device accessories,
8560, 8560:2, 8560:4**

Application

For ASSA modular locks 8561 or 8562.

- 8560:2 Recommended for entry doors, two-way opening
- 8560:4 Recommended for doors opened frequently from the outside

Features

- Two-piece plastic with two connecting break pins
- The plastic dome can be reused by assembling new break pins
- Assembled with two through-going screws in the handle follower
- Bottom plate: 69 mm Ø
- Available in several decorative finishes

Function

- To open, turn the plastic dome until the break pins snap. The plastic dome is then used to operate the thumbturn and to make exit possible.

- 8560: Opening device accessory for the inside. Cover rose on the outside.
- 8560:2: Opening device accessory for the inside and outside.
- 8560:4: Opening device accessory for the inside. Pull knob 496 on the outside.



8560



8560:2



8560:4

8561

Application

ASSA modular locks 8561* and 8562* are used in doors in power transformers, high voltage plants and similar places where possible fire damage can cause difficulties in opening the lock using a regular thumbturn.

Features

- Assembled with two through-going screws in the handle follower
- Available in several decorative finishes

Function

- Lever handle 640 for the inside, pull knob 496 for the outside. The inside handle always allows exit.



Lever handle



Pull knob

* Lock cases 8561 and 8562 have been discontinued.



**Opening device for modular locks,
8061**

Application

ASSA oval cylinders and double latch locks are used in doors equipped with access control systems to prevent opening via the thumbturn.

Not recommended for doors in evacuation routes. Also to be used with ASSA motor locks 8000S and 8001S.



8061

Features

- Used for inside assembly in combination with external oval cylinder
- Assembled with two through-going screws in the handle follower
- A plastic dome is fitted over the thumbturn in order to prevent uncontrolled opening
- The plastic dome can be replaced after opening

Function

- To open the door via the thumbturn, break the plastic dome
- A broken plastic dome indicates mechanical opening
- After opening, the thumbturn automatically returns to the initial position

Note!

Not approved to EN 179.

Opening device accessory 8065

Application

To prevent opening via the thumbturn in doors subject to an access control system. The accessory is designed to operate with cylinder and lever latch locks with backsets 50 and 70. It can also be used with ASSA motor locks with backset 50.

Features

- For inside assembly in combination with an external ASSA oval or round cylinder.
- A plastic dome is fitted over the thumbturn in order to prevent uncontrolled opening
- The plastic dome can be replaced after opening

Function

- To open the door via the thumbturn, break the plastic dome
- A broken plastic dome indicates mechanical opening
- After opening, the thumbturn goes back to start position due to a built-in magnet function



8065



Toilet accessories for Modular locks, 265, 265E, 5265, 9265, 95265, 9565T, 9565T2, 9566T2

Application

For institutions and public places.

Features

- Material: Brass
- Fits lock cases ASSA 565 and 310-50/70
- Can be opened from the outside
- Available in several decorative finishes
- Models 9265 and 95265 have an extended thumbturn for easier opening
- The length of the screws and the square spindle are chosen according to the door thickness

Function

- 265/265E: Inside thumbturn. 265E with thumbturn and outside indicator from the Epok series. Red/white indication on the inside and outside. Can be opened from the outside with a screwdriver.

- 5265: Inside thumbturn. Red/white indication on the inside and outside. Can be opened from the outside with a panic key.

- 9265: Extended thumbturn on the inside for easier opening. Red/white indication on the outside. Can be opened from the outside with a screwdriver.

- 95265: Extended thumbturn on the inside for easier opening. Red/white indication on the outside. Can be opened from the outside with a panic key.

- 9565T: Locked/opened from the inside by lifting the lever handle upwards and pressing it downwards, "Flip-up". Red/white indication on the outside. Can be opened from the outside with a screw driver.

- 9565T2: Locked/opened from the inside by lifting the lever handle upwards and pressing it downwards, "Flip-up". Red/white indication on the outside. Can be opened from the outside with a panic key.

- 9566T2: Locked/opened from the inside by lifting the lever handle upwards and pressing it downwards, "Flip-up". Red/white indication on the outside. Can be opened from the outside with a panic key.

Note!
When the C measurement is less than 20 mm a cover plate is needed on the inside, such as the ASSA 4291.



Toilet accessories, Villa series, 14890

Application

Toilet indicator 14890 is a toilet accessory in the Villa series intended for interior door locks FAS 2020, ABLOY 2014 and FAS 40T in the residential sector.

Features

- Material: Brass
- Finish: Bright chrome and satin chrome
- Rose: 52 mm Ø
- Red/white indication on the inside and outside
- Through-bolt fixing with two screws M4 Ø and loose nipples

Function

- Inside thumbturn
- Can be opened from the outside with a screwdriver



14890 Villa series

Toilet accessories, stainless steel, Toilet accessory 8265RF

Application

For toilet doors in all kinds of environments.

Features

- Fits ASSA lock cases 565 and 310-50/70
- Red/white indication on the inside and outside
- All visible parts made of satin brushed stainless steel
- The length of the screws and the square spindle are chosen according to the door thickness
- Through-bolt fixing with two screws 5 mm Ø and fixed nipples

Function

- Thumbturn function on the inside
- Can be opened from the outside with a screwdriver



8265RF



Toilet accessory 5614

Application

Toilet accessory 5614 is intended for use on light interior doors in the residential sector. We recommend complementing the accessories with the ASSA 5614 handle from the same series.

Features

- Material: Zinc
- Finish: bright chrome and Prion
- Rose: 49 mm Ø
- Red/white indication on the inside and outside
- Through-bolt fixing with two screws Ø 4 mm and fixed nipples
- For 40 mm door thickness

Function

- Inside thumbturn
- Can be opened from the outside

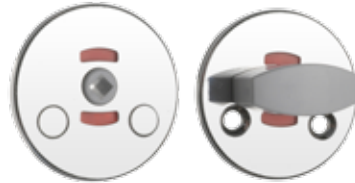

Toilet accessory 5614

Toilet accessory LH0341

Application

Toilet accessory LH0341 is intended for use in combination with ABLOY hook bolt lock case 4249 on light sliding doors.

Features

- Material: steel
- Finish: bright chrome
- For sliding doors up to 40 mm door with
- Red/white indication on the inside and outside
- Through-bolt fixing with two screws Ø 4 mm and fixed nipples

Function

- Inside thumbturn
- Can be opened from the outside



Toilet accessory LH0341



Cover plates for modular locks

4265

Application

Accessory to cover door preparation for cylinder.

Features

- Material: Brass
- Available in several decorative finishes
- 52 mm Ø
- Accessory to cover door preparation when cylinder is not installed



4265

992

Application

Accessory to cover door preparation for lever handle.

Features

- Available in several decorative finishes
- Through-bolt fixing with 5 mm Ø screws and nipples
- 52 mm Ø
- Accessory to cover door preparation when lever handle is not installed



992

Key plate 5614

Application

Keyplate 5614 is intended for use on light interior doors in the residential sector. We recommend complementing the accessory with the ASSA 5614 handle from the same series.

Features

- Material: Zinc
- Finish: bright chrome and Prion
- Through-bolt fixing with two screws, 4 mm Ø, and fixed nipples
- Rose: 49 mm Ø
- For 40 mm door thickness



Key plate 5614



4289

Application

Cover plate for use in combination with auxiliary locks.

Features

- Material: Brass
- Standard width: 70 mm Height: 175 mm
- Available in several decorative finishes

Function

- Decorative hardware
- Covers existing groundwork when the lock is replaced
- Cover plate for door strengthens accessory 4290



4289

64, 4291, 4291:1, 4294, 4295

Application

Cover/thumbturn plates for the Modular and Connect lock series.

Features

- Material: Brass
- Standard width: 70 mm Height: 230 mm (Also available in 60 mm width and 220 mm height)
- Available with and without opening for lever handle
- Comes in several decorative finishes
- Available as thumbturn cover plate

Function

- Decorative hardware
- Covers existing groundwork when the lock is replaced
- Cover plate for door strengthens accessory 4292 (70 mm width only)

- 64 Cover plate 60 mm, opening for cylinder/lever handle
- 4291 Cover plate 70 mm, opening for cylinder/lever handle
- 4291-1 Cover plate 70 mm, opening for cylinder only
- 4294-70 Thumbturn plate 70 mm, opening for cylinder/lever handle
- 4294-60 Thumbturn plate 60 mm, opening for cylinder/lever handle
- 4295-70 Plate set 70 mm thumbturn/cover plate, opening for cylinder/lever handle
- 4295-60 Plate set 60 mm thumbturn/cover plate, opening for cylinder/lever handle



64/4291

4291-1



4294-60/70



4256 RF/4356 RF

Application

Decorative longplate and thumbturn plate that can be combined with a variety of lock functions within the modular lock series plus lever handle and cylinder accessories.

Features

- Material: Stainless steel
- Constructed with two alternative functions: decoration plate or thumbturn plate
- Concealed mounting
- Dimensions: 216 x 60 x 3 mm
- Comment: 4356 RF-inside thumbturn plate for ASSA 2000 and 2002

Function

- Designed in the spirit of the Epok series, these plates are decorative hardware
- In combination with the ASSA 2000 or 2002, the thumbturn plate is ideal for convenient home locking
- The plate protects the door from damage and also covers existing damage



4256RF



4356 RF



4218, 4318, 4256, 4356

Application

Decorative longplate and thumbturn plate that can be combined with a variety of lock functions in the Modular lock series, as well as lever handle and cylinder accessories.

Features

- Material: Brass
- Constructed with two alternative functions; decorative plate or thumbturn plate
- Available in several decorative finishes
- Concealed mounting

Function

- The designed plates in the Epok series make decorative hardware
- In combination with the ASSA 2000 and 2002, the thumbturn plate is ideal for convenient home locking
- The decorative plate protects the door from damage and also covers existing damage



4218



4318

4218/4318

The design of these plates is inspired by buildings representing well-known Swedish architecture. The plate is designed for Epok lever handle 1956 as well as other handles and buildings with the 1950s spirit. Dimensions: 225 x 60 x 3 mm. Comment; 4318-in-side thumbturn plate for the ASSA 2000 and 2002.

4256/4356

The 1950s was the culmination of Swedish design. The discreet elegance of these plates reflects that era, and with roots in Swedish tradition it is well suited for the Epok lever handle 1956 as well as other handles and buildings with the 1950s spirit. Dimensions: 216 x 60 x 3 mm. Comment; 4356-in-side thumbturn plate for the ASSA 2000 and 2002.



4256



4356



4290

Application

Door reinforcement accessory for auxiliary locks.

Features

- Material: Steel
- Standard width: 66 mm, height: 170 mm
- Assembled with hardened nipples
- Complement with cover plate 4289 (70 mm width) for a decorative exterior

Function

- The through-bolt fixing and steel plates reinforce the door and make it more resistant to physical damage.



4290

4292

Application

Door reinforcement accessory for ASSA Modular and Connect locks.

Features

- Material: Steel
- Standard width: 66 mm, height: 230 mm
- Assembled with through-bolt fixing and hardened nipples
- Complemented with cover plate 4291 (70 mm width) or 4295-70 for a decorative exterior

Function

- The through-bolt fixing and steel plates reinforce the door and make it more resistant to physical damage.



4292



4859, 4959

Application

Decorative cylinder accessories for interior and exterior locking.

Features

- Material: Zinc
- Finish: Bright chrome
- Fits ASSA oval single cylinders
- The height of the cylinder ring and length of the screws and thumbturn follower are chosen according to door thickness
- Suits narrow profile latch locks

Function

- The cylinder ring helps prevent damage to the cylinder
 - 4859: With thumbturn plate and cylinder plate for the outside
 - 4959: With thumbturn plate and blind plate with no cylinder opening



4859

4959

4159, 4359, 4359 RC, 4459, 4459 RC

Application

Decorative cylinder accessories for interior and exterior locking.

Features

- Material: Zinc
- Finish: Bright chrome
- Fits ASSA oval double or single cylinders
- The height of the cylinder ring and length of the screws and thumbturn follower are chosen according to door thickness
- Suits narrow profile latch locks

Function

- The cylinder ring helps prevent damage to the cylinder
- Blind plate is available for one-way cylinder function
 - 4159: With blind plate and cylinder plate for the outside
 - 4359: With blind plate and cylinder plate for the inside
 - 4359 RC: With blind plate and cylinder plate for RD cylinder for the inside
 - 4459: For fitting double cylinder
 - 4459 RC: For fitting RC double cylinder



4159

4359



4459



5859, 5959

Application

Decorative cylinder accessories for interior and exterior locking.

Features

- Material: Zinc
- Finish: Bright chrome
- Fits ASSA oval single cylinders
- The height of the cylinder ring and length of the screws and thumbturn follower are chosen according to door thickness

Function

- The cylinder ring helps prevent damage to the cylinder
- With handle function
 - 5859: With handle and thumbturn plate for the inside and handle plate with cylinder for the outside
 - 5959: With handle and thumbturn plate for the inside and handle plate without cylinder for the outside



5859



5959

5059, 5159, 5359, 5359 RC, 5459, 5459 RC

Application

Decorative cylinder accessories for interior and exterior locking.

Features

- Material: Zinc
- Finish: Bright chrome
- Fits ASSA oval single and double cylinders
- The height of the cylinder ring and length of the screws and thumbturn follower are chosen according to door thickness
- Suits narrow profile handles and cylinder latch locks

Function

- The cylinder ring helps prevent damage to the cylinder
- Blind plate is available for one-way cylinder function
- With handle function
 - 5059: With handle plates with no cylinder opening
 - 5159: With handle for the inside and handle plate with cylinder opening for the outside
 - 5359: With lever handle and cylinder plate for the inside and handle plate with no cylinder opening for the outside
 - 5359 RC: With lever handle and cylinder plate for RC cylinder for inside and handle plate with no cylinder opening for the outside
 - 5459: With handle plates for fitting double cylinders
 - 5459 RC: With handle plates for fitting RC double cylinders



5159

5059



5459

5359



8362

Application

For narrow profile locks 1380, 1385 and 13 585 in doors with narrow frame profiles and equipped with an access control system to prevent opening via thumbturn.

Features

- Material: Zinc
- Finish: Bright chrome
- For inside assembly in combination with external ASSA oval cylinder
- Assembled with four through-going screws
- A plastic cover is fitted over the thumbturn in order to prevent uncontrolled opening
- The plastic cover can be replaced after opening
- Not recommended for doors in evacuation routes

Function

- To open the door, break the plastic cover
- A broken plastic cover indicates mechanical opening
 - 8362: Complete: Inside plate with opening device accessory and cylinder plate for the outside
 - 8362: Opening accessory: Inside plate with opening device accessory



8362



S3 opening accessory for Classic 88362/S3 narrow profile locks

Application

For narrow profile locks 1380, 1385 and 13 585 in doors with narrow frame profiles and equipped with an access control system to prevent opening via thumbturn.

Features

- Material: Zinc
- Finish: Bright chrome, satin chrome
- For inside assembly in combination with external ASSA oval cylinder
- Assembled with four through-going screws
- A plastic cover is fitted over the thumbturn in order to prevent uncontrolled opening
- The plastic cover can be replaced after opening
- Not recommended for doors in evacuation routes

Function

- To open the door, break the plastic cover
- A broken plastic cover indicates mechanical opening
 - 88362/S3: Complete: Inside plate with opening device accessory and cylinder plate for the outside
 - 88362/S3: Opening accessory: Inside plate with opening device accessory



88362/S3

S4 opening accessory for Connect 88362E/S4 narrow profile locks

Application

For narrow profile locks 231 and 232 in the Connect series for doors with narrow frame profiles and equipped with access control systems.

Features

- Material: Zinc
- Finish: Bright chrome, satin chrome
- For inside assembly in combination with external ASSA oval cylinder
- Assembled with four through-going screws
- A plastic cover is fitted over the thumbturn in order to prevent uncontrolled opening
- The plastic cover can be replaced after opening
- Not recommended for doors in evacuation routes

Function

- To open the door, break the plastic cover
- A broken plastic cover indicates mechanical opening
 - 88362E/S4: Complete: Inside plate with opening device accessory and cylinder plate for the outside
 - 88362E/S4: Opening accessory: Inside plate with opening device accessory



88362E/S4



44159, 44459

Application
Decorative cylinder accessories for interior and exterior locking.

- Features**
- Material: Zinc
 - Finish: Bright chrome, satin chrome
 - The length of the screws and thumbturn follower are chosen according to the door thickness
 - Suits narrow profile cylinder latch locks

- Function**
- A blind plate is available for one-way cylinder function
 - 44159: With blind plate and cylinder plate
 - 44459: For fitting double cylinders



44159



44459

44859, 44959

Application
Decorative cylinder accessories for interior and exterior locking.

- Features**
- Material: Zinc
 - Finish: Bright chrome, satin chrome
 - The length of the screws and thumbturn follower are chosen according to the door thickness
 - Suits narrow profile cylinder latch locks

- Function**
- 44859: With thumbturn plate and cylinder plate
 - 44959: With thumbturn plate and blind plate



44859



44959



55059, 55159, 55459

Application
Decorative cylinder accessories for interior and exterior locking.

- Features**
- Material: Zinc
 - Finish: Bright chrome, satin chrome
 - The length of the screws and thumbturn follower are chosen according to the door thickness
 - Suits narrow profile cylinder latch locks

- Function**
- A blind plate is available for one-way cylinder function
 - Handle function with return spring
 - 55059: With handle plates and no cylinder opening
 - 55159: With handle plate and handle plate with cylinder opening
 - 55459: With handle plates for fitting double cylinders



55059



55159



55459

55859, 55959

Application
Decorative cylinder accessories for interior and exterior locking.

- Features**
- Material: Zinc
 - Finish: Bright chrome, satin chrome
 - The length of the screws and thumbturn follower are chosen according to the door thickness
 - Suits narrow profile cylinder latch locks

- Function**
- A blind plate is available for one-way cylinder function
 - Handle function with return spring
 - 55859: With handle and thumbturn plate plus handle plate with cylinder opening
 - 55959: With handle and thumbturn plate plus handle plate without cylinder opening



55859



55959



44159E, 44459E

Application
Decorative cylinder accessories for interior and exterior locking.

- Features**
- Material: Zinc
 - Finish: Bright chrome, satin chrome
 - The length of the screws and thumbturn follower are chosen according to the door thickness
 - Suits narrow profile Connect cylinder locks with 35 mm backset

- Function**
- A blind plate is available for one-way cylinder function
 - 44159E: With blind plate and cylinder plate
 - 44459E: For fitting double cylinders



44159E



44459E

44859E, 44959E

Application
Decorative cylinder accessories for interior and exterior locking.

- Features**
- Material: Zinc
 - Finish: Bright chrome, satin chrome
 - The length of the screws and thumbturn follower are chosen according to the door thickness
 - Suits narrow profile Connect cylinder locks with 35 mm backset

- Function**
- 44859E: With thumbturn plate and cylinder plate
 - 44959E: With thumbturn plate and blind plate



44859E



44959E

Distance plate, S4 ROT

Application
Used when a 28 mm backset lock case is replaced by a 35 mm one.

- Features**
- Material: Stainless steel
 - Finish: Satin steel
 - Distance plate thickness: 1,5 mm

Function
The distance plate covers existing groundwork on the door when a 28 mm backset narrow profile lock case is replaced by a 35 mm backset lock case from the Connect series.



Distance plate S4 ROT



55059E, 55159E, 55459E

Application
Decorative cylinder accessories for interior and exterior locking.

- Features**
- Material: Zinc
 - Finish: Bright chrome, satin chrome
 - The length of the screws and thumbturn follower are chosen according to the door thickness
 - Suits narrow profile Connect cylinder locks with 35 mm backset

- Function**
- A blind plate is available for one-way cylinder function
 - Handle function with return spring
 - 55059E: With handle plates with no cylinder opening
 - 55159E: With handle plate and handle plate with cylinder opening
 - 55459E: With handle plates for fitting double cylinders



55059E



55159E



55459E

55859E, 55959E

Application
Decorative cylinder accessories for interior and exterior locking.

- Features**
- Material: Zinc
 - Finish: Bright chrome, satin chrome
 - The length of the screws and thumbturn follower are chosen according to the door thickness
 - Suits narrow profile Connect cylinder locks with 35 mm backset

- Function**
- A blind plate is available for one-way cylinder function
 - Handle function with return spring
 - 55859E: With handle and thumbturn plate plus handle plate with cylinder opening
 - 55959E: With handle and thumbturn plate plus handle plate with no cylinder opening



55859E



55959E



4559, 4559 RC, 4659, 4659 RC, 4759

Application

For night-time locking of shops, department stores, offices etc.

Features

- Material: Steel
- Finish: Bright chrome
- Fits ASSA oval single or double cylinders
- Suits narrow profile lock ASSA 13787
- Assembled with 3 hardened steel bolts and 3 one-way screws plus hardened nipples
- Can be complemented with 2 mm or 4 mm distance plates to fit different door thicknesses

Function

- The cylinder accessories prevent damage to the cylinder in the event of an attack
- The through-bolt fixing and the steel plates reinforce the door and make it more resistant to physical damage
 - 4559: For double cylinder
 - 4559 RC: For RC double cylinder
 - 4659: For single cylinder, outside assembling only
 - 4659 RC: For RC single cylinder, outside assembling only
 - 4759: For single cylinder, inside assembling only



4559



4659



4759



4559E, 4559E RC, 4659E, 4659E RC, 4759E, 4759E RC, 5559E, 5559E RC, 5659E, 5659E RC, 5759E

Application

For night-time locking of shops, department stores, offices etc.

Features

- Material: Steel
- Finish: Bright chrome
- Fits ASSA oval single or double cylinder
- Suits mechanical and motorised narrow profile Connect locks with hook bolt
- Assembled with 3 hardened steel bolts and 3 one-way screws plus hardened nipples
- Can be complemented with 2 mm or 4 mm distance plates to fit different door thicknesses
- The 4559E and 4759E can also be assembled with motor lock ASSA 811-35

Function

- The cylinder accessories prevent damage to the cylinder in the event of an attack
- The through-bolt fixing and steel plates reinforce the door and improve its resistance to physical damage
 - 4559E: For double cylinder. They suit motor lock ASSA 811-35.
 - 4559E RC: For RC double cylinder. They suit motor lock ASSA 811-35.
 - 4659E: For single cylinder, outside assembly only. They suit motor lock ASSA 811-35.
 - 4659E RC: For RC double cylinder, outside assembly only. They suit motor lock ASSA 811-35.
 - 4759E: For single cylinder, inside assembly only. They suit motor lock ASSA 811-35.
 - 4759E RC: For RC cylinder, inside assembly only. They suit motor lock ASSA 811-35.
 - 5559E: For double cylinder, with handle.
 - 5559E RC: For RC double cylinder, with handle.
 - 5659E: For single cylinder, outside assembly only. With handle.
 - 5659E RC: For RC double cylinder, outside assembly only. With handle.
 - 5759E: For single cylinder, inside only assembly. With handle.



4559E



5559E



4659E



5659E



4759E



5759E



Thumbturn cylinder 716, round

Application

For motor locks in combination with ASSA round outside cylinder. Equally suited to other ASSA Modular or Connect lock cases with 50 mm backset.

Features

- Used as a thumbturn in combination with an outside round cylinder
- Built-in, magnetic return mechanism for automatic, smooth return to initial thumbturn position
- Used in combination with ASSA accessory 3212

Function

- When the thumbturn is turned to open the lock, the magnetic return mechanism brings the thumbturn back to its original position.



Thumbturn cylinder 716, round

Thumbturn cylinder, oval

Application

Primarily designed for motor locks in combination with ASSA oval outside cylinder. Equally suited for use with other lock cases with 35 mm or 50 mm backset that have a 360° key turning function, such as the ASSA 8765 and ASSA 410 lock cases.

Features

- Used as a thumbturn in combination with an outside oval cylinder
- Built-in, magnetic return mechanism for automatic, smooth return to initial thumbturn position

Function

- When the thumbturn is turned to open the lock, the magnetic return mechanism brings the thumbturn back to its original position.



Thumbturn cylinder, oval



Opening device 84562E, for Connect

Application

For the ASSA 811S-35 hook bolt lock in the Connect series.

Features

- Material: Steel
- Finish: Bright chrome
- For inside assembly in combination with an external ASSA oval cylinder
- A thumbturn cylinder with a thumbturn for the inside is included
- A plastic cover is mounted over the thumbturn
- Assembled with 3 hardened steel bolts and 3 one-way screws plus hardened nipples
- Standard for 65 mm door thickness with the lock case assembled in the center
- Can be complemented with 2 mm or 4 mm distance plates to fit different door thicknesses
- Not recommended for doors in evacuation routes

Function

- To open the door via the thumbturn, break the plastic dome.
 - 84562: Inside plate with opening device accessory and cylinder plate for the outside
 - 84562:1 Inside plate with opening device accessory
 - 84562:2 Opening device accessory only



84562E

Opening device 84562, for Classic

Application

For the ASSA 8087S hook bolt lock in the Classic series.

Features

- Material: Steel
- Finish: Bright chrome
- For inside assembly in combination with an external ASSA oval cylinder
- Thumbturn cylinder with a thumbturn for the inside is included
- A plastic cover is mounted over the thumbturn
- Assembled with 3 hardened steel bolts and 3 one-way screws plus hardened nipples
- Standard for 65 mm door thickness with the lock case assembled in the center
- Can be complemented with 2 mm or 4 mm distance plates to fit different door thicknesses
- Not recommended for doors in evacuation routes

Function

- To open the door via the thumbturn, break the plastic dome.
 - 84562: Inside plate with opening device accessory and cylinder plate for the outside
 - 84562:1 Inside plate with opening device accessory
 - 84562:2 Opening device accessory only



84562



84559, 84559 RC, 84659, 84659 RC, 84759, 84759 RC

Application

For night-time locking of shops, department stores, offices etc. in combination with hook bolt motor lock ASSA 8087S.

Features

- Material: Steel
- Finish: Bright chrome
- For ASSA narrow profile motor locks
- Assembled with 3 hardened steel bolts and 3 one-way screws plus hardened nipples
- Can be complemented with 2 mm or 4 mm distance plates to fit different door thicknesses

Function

- The cylinder accessories prevent damage to the cylinder in event of an attack
- The through-bolt fixing and steel plates reinforce the door and make it more resistant to physical damage
 - 84559: For double cylinder
 - 84659: For single cylinder, outside assembly only
 - 84759: For single cylinder, inside assembly only



84559



84659



84759



Wall key deposit 390877

Application

Wall key deposit for local service keys etc.

Features

- Complemented with cylinder and suitable lever handle for assembly in wall according to the instructions
- Available with built-in microswitch for alarm device
- Assembly recessed in the wall at a recommended 1.5-2 m height recommended
- Wall key deposit: 45 mm Ø. Length: 137 mm

Can be combined with the following cylinders:
Cylinder dp 4418

- 390877-100 Key deposit tube
- 390877-130 Key deposit tube with micro-switch
- 491859 Hardened socket for frontal protection. 51 mm Ø. 0Length: 25 mm
- 466646 Fixing plate with bolt and nut. 60 mm Ø



Wall key deposit 390877



Wall key deposit 390877



Rim lock cover 2896

Application

For surface mounting of Modular locks in thin doors and gates.

Features

- Material: Bright nickel-plated steel
- Can be assembled with screws (6 mm Ø), rivets or by welding
- For symmetrical lock cases in the Modular lock case series
- For lock cases with 50 mm backsets

Function

- Allows surface mounting of modular locks



Rim lock cover 2896

Automatic sealing threshold, ASSA T 100

Application

For fire, smoke and sound insulation in wooden swing doors where a regular threshold cannot be installed.

Features

- Flush mounting on the lower edge of the door or with a surface mounting strip
- Available in several lengths as standard and can easily be adapted to doors between 288 mm and 1324 mm. Other lengths can be ordered
- Easy to adjust for floor chinks 5-20 mm
- When flush mounted the ASSA T 100 is approved for fire-resistant doors of class EI 30
- When flush mounted it is approved up to a sound proofing rating of R'w 35 dB if mounted in R'w 40 dB wooden door
- Minimum of 2 million openings
- For both right and left-opening doors

Function

- When the door is closed and the adjustable pin meets the door frame, the sealing threshold drops quickly and silently to the floor. When the door is opened and the adjustable pin leaves the door frame, the mechanism lifts the sealing strip immediately so that it does not scrape the floor while opening.
- The sealing threshold is designed to level automatically if the floor slopes and to function silently.



Automatic sealing threshold ASSA T 100

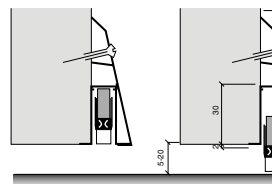

External mounting strip made of aluminium

Accessories

Strike plates for the short ends of the sealing threshold. Aluminium strip for surface mounting.

Note!

If aluminium strip is used, the T100 is not approved for fire and sound classification.



Climate protection

Application

Ideal for gates and doors in harsh environments. Protects the cylinder against rain, snow and dust.

Features

- Material: Stainless steel and rubber
- Suits ASSA round and oval cylinders

Function

- Assembled under the cylinder ring
- Pre-drilled holes for fixing screws or welding



Climate protection

Door stops

Application

Door stops for wall or floor mounting to prevent the door from causing damage to the wall. Made of stainless steel, ASSA's innovative door stops are durable and long lasting.

Features

- Finish: Satin brushed stainless steel and black rubber
- Mounted on the wall or floor with enclosed screws

Function

- Prevents the door from causing damage to the wall
- Facilitates floor cleaning when mounted on wall

- 8625G: floor mounted, ø 45 mm, height 25 mm
- 8655G: floor mounted, ø 20 mm, height 55 mm
- 8670V: wall mounted, Rose: ø 50 mm x 5 mm, length 70 mm
- 8645G: floor mounted, Rose: ø 50 mm x 5 mm, height 45 mm
- 8675G/V: wall or floor mounted, Rose: ø 50 mm x 5 mm, height 75 mm



8625G-25 mm floor



8655G-55 mm floor



8670V-70 mm wall



8645G-45 mm floor



8675G/V-75 mm wall/floor



Panic exit device ASSA 1125

Application

Panic exit device for outgoing modular profile doors. Intended for use with an ASSA lock case with 50/70 mm backset. Ideal for emergency escape doors in shopping malls, hotels, schools, hospitals, theaters, arenas etc. where panic can arise during evacuation.

Features

- Panic exit device with horizontal pushbar
- Certified and CE-approved according to the European Standard EN 1125, and the Construction Products Directive, 89/106/EEG
- Approved for installation on fire-resistant doors up to and including class E/EI60
- Available in various lengths for various door module dimensions
 - 1125 M8 For door leaf width: 680-830 mm
 - 1125 M9-10 For door leaf width: 830-1 030 mm
 - 1125 M11-14 For door leaf width: 1030-1400 mm
- All visible parts made of satin brushed stainless steel
- Available in left or right-opening versions
- Fits the ASSA 725, 4625, 4825, 5625, 5825, 6525 and 7625 cylinder kits

Function

- The door can always be opened from the inside using the panic exit device
- Microswitch function in the lock case (option) indicates use of the panic exit device
- Authorised passage by key from both the inside and the outside is always possible
- Installing a handle on the outside of the door allows re-entry

The ASSA 1125 fits the following ASSA lock cases:

- 761-50/70 mm
- 762-50/70 mm
- 767-50/70 mm
- 772-50/70 mm



ASSA 1125



Accessories 3325 and 3425 for panic exit devices ASSA 1125 and 1130

Application

Accessory for decorative and functional installation in combination with panic pushbar ASSA 1125/1130 and lock cases with backsets of 50/70 mm.

Features

- Material: Brass
- For installation with cylinder types: ASSA 725, 4625, 4825, 5625, 5825, 6525 or 7625
- Available in several decorative finishes

Function

- Accessory for decorative and functional mounting
- 3325: Decorative cylinder socket and round cylinder ring. Lever handle ASSA 6696 for the outside. The external handle on the door allows re-entry.
 - 3425: Decorative cylinder socket and round cylinder ring. Cover plate for outside lever handle space. After opening the door it returns to locked position and cannot be opened from the outside without a key.



3325



3425



Connect lock case for panic exit device ASSA 1125

Lock case 761-50, -70

- Lock case with interlocked cylinder latch bolt and lever handle latch bolt
- The outside lever handle allows re-entry when combined with the electric strike plate, which automatically switches to an unlocked position after indication from the fire alarm or evacuation alarm
- Lever handle latch bolt keeps the door closed in the event of fire
- Cylinder latch bolt, lockable into lock case with lock back key
- Can be combined with a electric strike in the ASSA 900-series
- Available with MJ microswitch, see microswitch functions at page 200
- Authorized opening with key via the cylinder
- Intended for use with panic exit device ASSA 1125



761-50

Lock case 762-50, -70

- Lock case with interlocked cylinder latch bolt and lever handle latch bolt
- The outside lever handle allows re-entry when combined with the electric strike plate, which automatically switches to an unlocked position after indication from the fire alarm or evacuation alarm
- Lever handle latch bolt keeps the door closed in case of fire
- Cylinder latch bolt not lockable into lock case
- Can be combined with a electric strike in the ASSA 900-series
- Available with MJ microswitch, see microswitch functions at page 200
- Authorized opening with key via the cylinder
- Intended for use with panic exit device ASSA 1125



762-50



Connect lock case for panic exit device ASSA 1125

Lock case 767-50, -70

- Lock case with interlocked cylinder latch bolt and lever handle latch bolt
- Re-entry is assured by not relocking the cylinder latch after opening. Reset by cylinder function.
- Lever handle latch bolt keeps the door closed in case of fire
- Can be combined with a electric strike in the ASSA 900-series
- Available with MI microswitch, see microswitch functions at page 200
- Authorized opening with key via the cylinder
- Intended for use with panic exit device ASSA 1125



767-50

Lock case 772-50, -70

- Lock case with interlocked cylinder latch bolt
- Cylinder latch bolt keeps the door closed in case of fire
- Cylinder latch bolt not lockable into lock case
- Can be combined with a electric strike in the ASSA 900-series
- Available with MJ microswitch, see microswitch functions at page 200
- Authorized opening with key via the cylinder
- Intended for use with panic exit device ASSA 1125



772-50



Panic exit device ASSA 1125:1

Application

Panic exit device used for the passive door leaf of outgoing modular profile double doors. Ideal for emergency exit doors in shopping malls, hotels, schools, hospitals, theaters, arenas etc. where panic can arise during evacuation.

Features

- Panic exit device with horizontal pushbar
- Certified and CE-approved according to the European Standard EN 1125 and Construction Products Directive 89/106/EEG
- Approved for installation on fire-resistant doors up to and including class E/EI 60
- Available in different lengths for different door module dimensions:
 - 1125 M8 For door leaf width; 680-830 mm
 - 1125 M9-10 For door leaf width; 830-1030 mm
 - 1125 M11-14 For door leaf width; 1030-1400 mm
- All visible parts made of satin brushed stainless steel
- Available in left or right-opening versions
- Operates by vertical rods and externally placed deadlocked latches
- The maximum height of door leaf is 2130 mm. With an extension set the maximum height of the door leaf extends to 3100 mm

Function

- The passive door leaf can be opened from the inside irrespective of the active door leaf by using the push bar
- Microswitch function indicates use of the panic exit device



1125:1



ASSA 2530 panic strike plate for passive panic exit device 1125:1 and 1130:1

Application

Strike plate for passive exit devices ASSA 1125:1 and ASSA 1130:1. Secures escape through passive door leaf in outward-opening double doors independent of the active door leaf. Intended for use with lock cases ASSA 761, 762, 767 and 772 in 35, 50 or 70 mm backset.

Always recommended when both door leaves in a double door are supplied with panic exit devices.

Features

- Made of steel for fireproof doors
- Fits both modular and narrow profile doors
- Available in left or right-opening versions for wood and metal doors.
- Available in 35, 50 or 70 mm backset

Function

When opening with the panic exit device on the passive door leaf, the lip on the strike plate is displaced. After closing, the strike plate returns to locked position.



2530-50 For metal doors

2530-50 For wood doors

Door guide ASSA 2010

Application

For dual doors in fire cell with door coordinator.

Features

- Material: Steel
- Jointed function with roll-wheel of steel

Function

- Mounted on upper side of passive door leaf on door in fire cell equipped with door coordinator
- Supports safe closing after exit because the active door leaf automatically opens when the passive leaf opens. This ensures that the door leaves closes in the right order and secures a fireproof enclosure.



2010



Panic exit device ASSA 1130

Application

Panic exit device for outgoing modular or narrow profile doors. Intended for use with an ASSA lock case with 35/50/70 mm backset. Ideal for emergency escape doors in shopping malls, hotels, schools, hospitals, theaters, arenas etc. where panic can arise during evacuation.

Features

- Panic exit device with horizontal pushbar
- Certified and CE-approved according to the European Standard EN 1125 and the Construction Products Directive, 89/106/EEG
- Approved for installation on fire-resistant doors up to and including class E/EI60
- Pushbar length 1150 mm (1350 mm optional)
- The pushbar can easily be cut to fit the actual width of the door leaf
- Pushbar and cover parts are made of satin brushed stainless steel
- Turnable for left and right-opening doors
- Can be combined with accessories from the ASSA S4 narrow profile range for the outside of the door

Function

- The door can always be opened from the inside by using the pushbar
- Microswitch function in the lock case (option) indicates use of the panic exit device
- Authorized passage by key from both the inside and the outside is always possible
- Installing an external handle on the door allows re-entry

The ASSA 1130 fits the following ASSA lock cases:

- 761-35/50/70
- 762-35/50/70
- 767-35/50/70
- 772-35/50/70



1130



Connect lock case for panic exit device ASSA 1130

Lock case 761-35, -50, -70

- Lock case with interlocked cylinder latch bolt and lever handle latch bolt
- The outside lever handle allows re-entry when combined with the electric strike plate, which automatically switches to an unlocked position after indication from the fire alarm or evacuation alarm
- Lever handle latch bolt keeps the door closed in case of fire
- Cylinder latch bolt, lockable into lock case with lock-back key
- Can be combined with a electric strike in the ASSA 900-series
- Available with MJ microswitch, see microswitch functions at page 200
- Authorized opening with key via the cylinder
- Intended for use with panic exit device ASSA 1130



761-35

761-50

Lock case 762-35, -50, -70

- Lock case with interlocked cylinder latch bolt and lever handle latch bolt
- The outside lever handle allows re-entry when combined with the electric strike plate, which automatically switches to an unlocked position after indication from the fire alarm or evacuation alarm
- Lever handle latch bolt keeps the door closed in case of fire
- Cylinder latch bolt not lockable into lock case
- Can be combined with a electric strike in the ASSA 900-series
- Available with MJ microswitch, see microswitch functions at page 200
- Authorized opening with key via the cylinder
- Intended for use with panic exit device ASSA 1130



762-50

762-70



Connect lock case for panic exit device ASSA 1130

Lock case 767-35, -50, -70

- Lock case with interlocked cylinder latch bolt and lever handle latch bolt
- Re-entry is assured by not relocking the cylinder latch after opening. Reset by cylinder function.
- Lever handle latch bolt keeps the door closed in case of fire
- Can be combined with a electric strike in the ASSA 900-series
- Available with MI microswitch, see microswitch functions at page 200
- Authorized opening with key via the cylinder
- Intended for use with panic exit device ASSA 1130



Lock case 772-35, -50, -70

- Lock case with interlocked cylinder latch bolt
- Cylinder latch bolt keeps the door closed in case of fire
- Cylinder latch bolt not lockable into lock case
- Can be combined with a electric strike in the ASSA 900-series
- Available with MJ microswitch, see microswitch functions at page 200
- Authorized opening with key via the cylinder
- Intended for use with panic exit device ASSA 1130



Panic exit device ASSA 1130:1

Application

Panic exit device used for passive door leaf of out-going modular or narrow profile double doors. Ideal for emergency escape doors in shopping malls, hotels, schools, hospitals, theaters, arenas etc. where panic can arise during evacuation.

Features

- Panic exit device with horizontal pushbar
- Certified and CE-approved according to the European Standard EN 1125 and the Construction Products Directive, 89/106/EEG
- Approved for installation on fire-resistant doors up to and including class E/EI60
- Pushbar length for 1150 mm (option 1350 mm)
- The pushbar can easily be cut to fit the actual width of the door leaf
- Pushbar and cover parts are made of satin brushed stainless steel
- Turnable for left and right-opening doors
- Operates by vertical rods and externally placed latches
- Maximum height of door leaf is 2150 mm. With an extension set, the maximum height of the door leaf extends to 3200 mm

Function

- The passive door leaf can be opened from the inside irrespective of the active door leaf by using the pushbar
- Microswitch function indicates use of the panic exit device

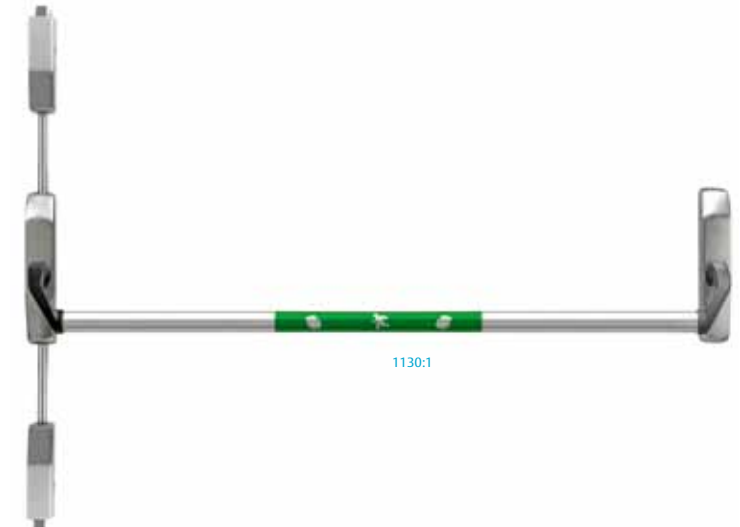



1150 Panic device

ASSA 1150-series

Application

Panic exit device for outgoing modular or narrow profile doors. Ideal for emergency escape doors in shopping malls, hotels, schools, hospitals, theaters, arenas etc. where panic can arise during evacuation.

Features

- Certified and CE marked in accordance with the requirements of European Standard EN 1125
- Panic device with integral horizontal bar for both active and passive door leaf
- Pullman latch in steel with interlocking
 - 1150 and 1150:1 are approved for use in fire doors
- 1151, 1151:1 can be put in unlocked position
- Available in two lengths: 900 mm and 1200 mm
- Extension kit for passive door at the door height >2100 mm
- Push bar can be easily cut to fit the current door dimensions
- Push bar and covers are made of powder coated aluminum
- Available in reversible left or right version

Function

- The door can always be opened from inside by the panic bar
- Can be supplemented with external lockable or non-lockable handle



1160 Panic device

ASSA 1160-series

Application

Panic exit device for outgoing modular or narrow profile doors. Ideal for emergency escape doors in shopping malls, hotels, schools, hospitals, theaters, arenas etc. where panic can arise during evacuation.

Features

- Certified and CE marked in accordance with the requirements of European Standard EN 1125
- Panic device with exposed horizontal bar for both active and passive door leaf
- Pullman latch in steel with interlocking
 - 1160 and 1160:1 are approved for use in fire doors
- 1161 and 1161:1 can be put in unlocked position
- Available in length 1200 mm
- Extension kit for passive door at the door height >2100 mm
- Push bar can be easily cut to fit the current door dimensions
- Push bar made of powder coated steel and covers in powder-coated aluminum
- Available in reversible left or right version

Function

- The door can always be opened from inside by the panic bar
- Can be supplemented with external lockable or non-lockable handle



Emergency exit device ASSA 179

Application

ASSA 179 series is intended for hinged modular doors in escape routes where no special exit routines are set. The lock is operated by a one-hand grip that provides a safe exit. The 179 series offers several types of lock cases that provide functional solutions for different demands, for example the need for re-entry in case of fire and smoke in the escape route.

Features

- Emergency exit device ASSA 179 is certified and CE-approved according to the European Standard EN 179 and the Construction Products Directive, 89/106/EEC, and is also approved for installation on fire-resistant doors up to and including class EI 60 (711-50/70 not included)
- The lock case is available with a built-in microswitch which indicates use of the emergency exit handle, and indication for locked/unlocked deadbolt alternative deadlocked latch
- Finish: Prion, nickel, chrome and satin chrome

Function

- The door can always be opened from the inside using the emergency exit handle
- Depending on the lock case model, re-entry is possible using an outside lever handle
- The lock case models can be used in combination with electric strike plates for integration in access control systems
- Authorized opening with a key is always possible from both inside and outside without affecting the alarm system
- Available with security sealing thread
- The 3 mm distance plate, 179, is recommended for doors with a C measurement less than 22 mm

The 179A fits the following ASSA lock cases:

- 710-50/70
- 721-50/70
- 722-50/70
- 727-50/70

The 179B fits the following ASSA lock cases:

- 711-50/70
- 732-50/70

The 179C fit the following ABLOY motor lock case:

- EL874

The 179D fit the following ABLOY motor lock case:

- EL875

The 179E-2 fit the following ABLOY solenoid lock case:

- EL580



Connect lock case for emergency exit device ASSA 179

Lock case 710-50/70

- Lock case with hook bolt and lever handle latch bolt
- The outside lever handle allows re-entry
- Lever handle latch bolt keeps the door closed in the event of fire
- Can be combined with the STEP 18/28E electric strike plate
- Available with ME microswitch, see microswitch functions at page 200
- Authorized opening with key via the cylinder
- Intended for use with accessory 179A



710-50

Lock case 711-50/70

- Lock case with hook bolt
- No door holding in the event of fire
- Can be combined with the STEP 18 electric strike plate
- Available with ME microswitch, see microswitch functions at page 200
- Authorized opening with key via the cylinder
- Intended for use with accessory 179B



711-50

Lock case 721-50/70

- Lock case with interlocked cylinder latch bolt and lever handle latch bolt
- The outside lever handle allows re-entry when combined with the electric strike plate, which automatically switches to an unlocked position after indication from the fire alarm or evacuation alarm
- Lever handle latch bolt keeps the door closed in case of fire
- Cylinder latch bolt, lockable into lock case with lockback key
- Can be combined with a electric strike in the ASSA 900-series
- Available with MG microswitch, see microswitch functions at page 200
- Authorized opening with key via the cylinder
- Intended for use with accessory 179A



721-50



Connect lock case for emergency exit device ASSA 179

Lock case 722-50/70

- Lock case with interlocked cylinder latch bolt and lever handle latch bolt
- The outside lever handle allows re-entry when combined with the electric strike plate, which automatically switches to an unlocked position after indication from the fire alarm or evacuation alarm
- Lever handle latch bolt keeps the door closed in case of fire
- Cylinder latch bolt not lockable into lock case
- Can be combined with a electric strike in the ASSA 900-series
- Available with MG microswitch, see microswitch functions at page 200
- Authorized opening with key via the cylinder
- Intended for use with accessory 179A



722-50

Lock case 727-50/70

- Lock case with interlocked cylinder latch bolt and lever handle latch bolt
- Re-entry is assured by not relocking the cylinder latch after opening. Reset by cylinder function.
- Lever handle latch bolt keeps the door closed in case of fire
- Can be combined with a electric strike in the ASSA 900-series
- Available with MK microswitch, see microswitch functions at page 200
- Authorized opening with key via the cylinder
- Intended for use with accessory 179A



727-50

Lock case 732-50/70

- Lock case with interlocked cylinder latch bolt
- Cylinder latch bolt keeps the door closed in case of fire
- Cylinder latch bolt not lockable into lock case
- Can be combined with a electric strike in the ASSA 900-series
- Available with MG microswitch, see microswitch functions at page 200
- Authorized opening with key via the cylinder
- Intended for use with accessory 179B



732-50



Emergency exit device ASSA 179 S4

Application

The ASSA 179 S4 series is intended for hinged narrow-profile doors in escape routes where no special exit routines are set. The lock is operated by a one-hand grip, ensuring provides a quick exit. The 179 S4 series offers several types of lock cases that provide functional solutions for different demands, for example the need for re-entry in case of fire and smoke in the escape route.

Features

- Emergency exit device ASSA 179 S4 is certified and CE-approved according to the European Standard EN 179 and the Construction Products Directive, 89/106/EEG, and is also approved for installation on fire-resistant doors up to and including class EI 60 (711-35 not included)
- The lock case is available with a built-in microswitch which indicates use of the emergency exit handle, and indication for locked/unlocked deadbolt alternative deadlocked latch
- Available in bright chrome or satin chrome

Function

- The door can always be opened from the inside using the emergency exit handle
- Depending on lock case model, regain of entry is possible by outside lever handle
- The lock case models can be used in combination with electric strike plates for integration in access control systems
- Authorized opening with a key is always possible from both inside and outside without affecting the alarm system
- Available with security sealing thread
- The 3 mm distance plate S3/S4 is recommended for doors with a C measurement less than 22 mm

The 179A S4 fits the following ASSA lock cases:

- 710-35
- 721-35
- 722-35
- 727-35

The 179B S4 fits the following ASSA lock cases:

- 711-35
- 732-35



179A S4



179A S4 DC



179A-2 S4



179B S4



179B S4 DC



179B-2 S4



Connect lock cases for emergency exit device ASSA 179 S4

Lock case 710-35

- Lock case with hook bolt and lever handle latch bolt
- The outside lever handle allows re-entry
- Lever handle latch bolt keeps the door closed in case of fire
- Can be combined with the STEP 18/28E electric strike plates
- Available with ME microswitch, see microswitch functions at page 200
- Authorized opening with key via the cylinder
- Intended for use with accessory 179A S4



710-35

Lock case 711-35

- Lock case with hook bolt
- The outside lever handle allows re-entry
- Can be combined with the STEP 18 electric strike plate
- Available with ME microswitch, see microswitch functions at page 200
- Authorized opening with key via the cylinder
- Intended for use with accessory 179B S4



711-35

Lock case 721-35

- Lock case with interlocked cylinder latch bolt and lever handle latch bolt
- The outside lever handle allows re-entry when combined with the electric strike plate, which automatically switches to an unlocked position after indication from the fire alarm or evacuation alarm
- The outside lever handle allows re-entry
- Cylinder latch bolt, lockable into lock case with lockback key
- Can be combined with a electric strike in the ASSA 900-series
- Available with MG microswitch, see microswitch functions at page 200
- Authorized opening with key via the cylinder
- Intended for use with accessory 179A S4



721-35



Connect lock cases for emergency exit device ASSA 179 S4

Lock case 722-35

- Lock case with interlocked cylinder latch bolt and lever handle latch bolt
- The outside lever handle allows re-entry when combined with the electric strike plate, which automatically switches to an unlocked position after indication from the fire alarm or evacuation alarm
- The outside lever handle allows re-entry
- Cylinder latch bolt not lockable into lock case
- Can be combined with a electric strike in the ASSA 900-series
- Available with MG microswitch, see microswitch functions at page 200
- Authorized opening with key via the cylinder
- Intended for use with accessory 179A S4



722-35

Lock case 727-35

- Lock case with interlocked cylinder latch bolt and lever handle latch bolt
- Re-entry is assured by not relocking the cylinder latch after opening. Reset by cylinder function.
- The outside lever handle allows re-entry
- Can be combined with a electric strike in the ASSA 900-series
- Available with MK microswitch, see microswitch functions at page 200
- Authorized opening with key via the cylinder
- Intended for use with accessory 179A S4



727-35

Lock case 732-35

- Lock case with interlocked cylinder latch bolt
- The outside lever handle allows re-entry
- Cylinder latch bolt, lockable into lock case with lock-back key
- Can be combined with a electric strike in the ASSA 900-series
- Available with MG microswitch, see microswitch functions at page 200
- Authorized opening with key via the cylinder
- Intended for use with accessory 179B S4



732-35



LOCK CASES

ASSA provides the widest range of lock cases and strike plates. Our lock cases satisfy all your safety, comfort and emergency-evacuation requirements. They are designed to be installed in fire doors and comply with current standards and CE certification requirements.

The products are compatible with the most common types of mortice and door solutions available on the market. The range includes hook bolt locks, approved locks, split spindle locks, emergency escape locks, night latches (single and double) and adjustable security strike plates. Most of the locks can be ordered with built-in microswitches for electronically controlled doors and access control.





Modular lock with round cylinder/thumbturn

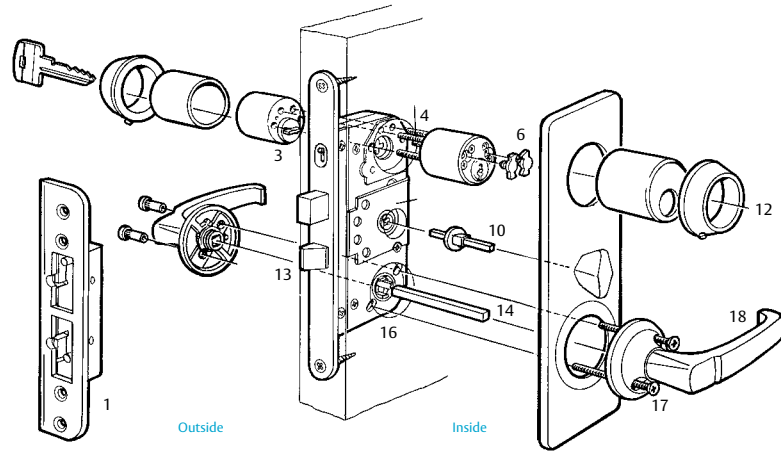

Narrow profile locks with SCD security accessories

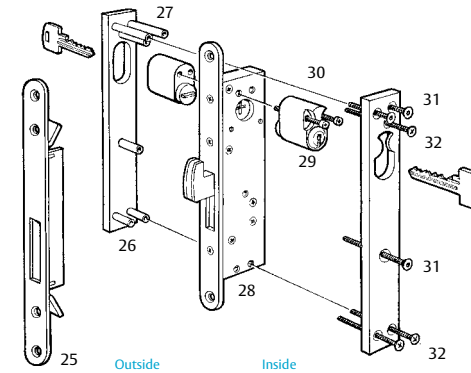

Round cylinder with thumbturn cylinder

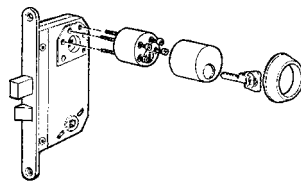

Modular lock with oval double cylinder (DC)

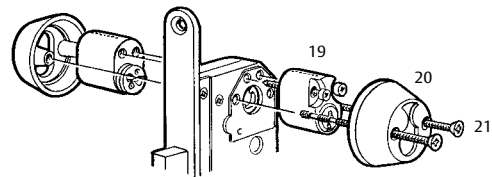

Oval single cylinder and thumbturn

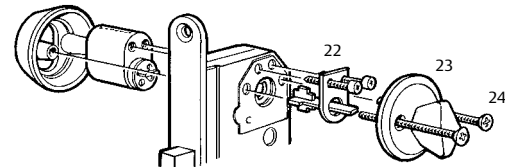

Narrow profile locks with standard accessories

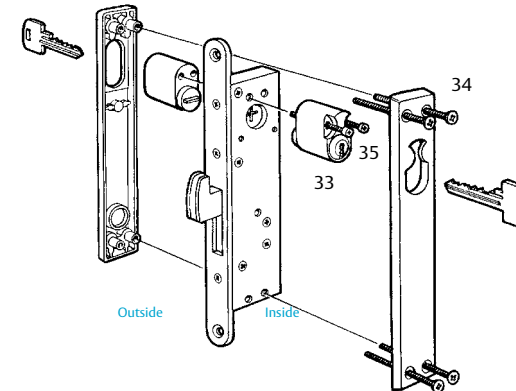

1. Security strike plates
2. Barrel nut
3. Extension piece
4. High resistance screw
5. Cylinder
6. Cylinder plug
7. Cylinder
8. Deadbolt
9. Manipulator protection
10. Thumbturn follower
11. Thumbturn plate
12. Cylinder ring
13. Lever handle latch bolt
14. Lever handle follower
15. Forend
16. Lock case
17. Lever handle screw
18. Lever handle

19. Cylinder
20. Cylinder ring
21. Cylinder screw

22. Thumbturn tailpiece
23. Thumbturn
24. Thumbturn screw

25. Security strike plates
26. Cylinder plate
27. Nipple
28. Lock case
29. Cylinder
30. Cylinder screw
31. High resistance screw
32. One-way screw









33. Cylinder
34. Plate screw
35. Cylinder screw













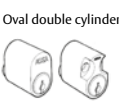
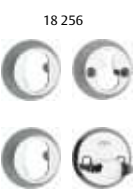









Accessories, modular locks

Choose your lock accessories in accordance with existing design, security and functional requirements. The following matrices display products related to commonly used mechanical lock units.

Products marked in red fulfil the requirements of EN 12209 security grade 5.

Sash lock	Cylinder type	Cylinder accessories	Reinforcement accessories	Security strike plate	Lever handle
 8765	 Round double cylinder	 3211	 4292	 1887 1-4	 6616
		 3212		 1887-5	 6640

Sash lock	Night latch	Cylinder type	Cylinder accessories	Cover plate	Strike plate	Lever handle
 565	 560	 Oval double cylinder	 18 256	 4291	 2864-1	 1949
		 Oval cylinder outside	 256		 2860-5	







Sash lock 2000	Cylinder type	Cylinder accessories	Reinforcement accessories/ Cover plate	Security strike plate	Lever handle
 2000	 Round double cylinder	 3212	 4292	 1887 1-4	 1918
			 4295	 1887-5	 1956
					 6638
					 6647







Accessories, extra locks/narrow profile locks







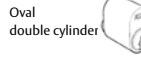

Choose your lock accessories in accordance with existing design, security and functional requirements. The following matrices display products related to commonly found mechanical lock units.

Products marked in red fulfil the requirements of EN 12209 security grade 5.

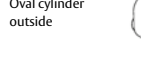
Deadlock	Cylinder type	Cylinder accessories	Reinforcement accessories	Security strike plate
 8788	 Round double cylinder	 3211	 4290	 1888-1
		 3212		 1888-5

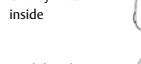
Cylinder sash lock	Cylinder type	Cylinder accessories	Cover plate	Strike plate
 585	 Oval double cylinder	 18 256	 4289	 2864-1
	 Oval cylinder outside	 256		

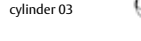









Narrow profile lock, hook bolt	Cylinder type	Security accessories	Security strike plate
 13 787	 Oval double cylinder	 4559	 1887-9
	 Oval cylinder outside	 4659	
	 Oval cylinder inside	 4759	
	 Oval thumbturn cylinder 03		











Accessories, narrow profile locks

Choose your lock accessories in accordance with existing design, security and functional requirements.

The following matrices display products related to commonly found mechanical lock units.

Cylinder sash lock	Cylinder type	Cylinder accessories	Strike plate
 1385	Oval double cylinder 	 44459	 2885
 13 585	Oval cylinder outside 	 44859	
 1380	Oval cylinder inside 	 44159	

Double sash lock	Cylinder type	Cylinder accessories	Strike plate
 1362	Oval double cylinder 	 55459	 2864-1
	Oval cylinder outside 	 55859	
	Oval cylinder inside 	 55159	









Lever handle sash lock	Cylinder accessories	Strike plate
 1398	 55059	 2885

























Accessories, Connect

Choose your lock accessories in accordance with existing design, security and functional requirements. The following matrices display products related to commonly found mechanical lock units.

Products marked in red fulfil the requirements of 12209 security grade 5.

Sash lock	Cylinder type	Cylinder accessories	Reinforcement accessories	Security strike plate	Lever handle
 410-50	Round double cylinder 	 3212	 4292	 1487 1-4	 6616
		 3211		 1489-11	 6640

Sash lock	Night latch	Cylinder type	Cylinder accessories	Cover plate	Strike plate	Lever handle
 310-50	 220-50	Oval double cylinder 	 18 256	 4291	 1264 1-4	 1905
		Oval cylinder outside 	 256		 1264 5-7	 1949









Sash lock 2002	Cylinder type	Cylinder accessories	Reinforcement accessories/ Cover plate	Security strike plate	Lever handle	
 2002-50	Round double cylinder 	 3212	 4292	 4295	 1487 1-4	 1918
				 1489-11	 1956	
					 6638	
					 6647	











Accessories, Connect narrow profile locks

Choose your lock accessories in accordance with existing design, security and functional requirements. The following matrices display products related to commonly found mechanical lock units.

Products marked in red fulfil the requirements of EN 12209 security grade 5.

Narrow profile lock, two-step bolt	Cylinder type	Security accessories	Security strike plate
 410-35	Oval double cylinder 	 5559E	 1487-9
	Oval cylinder outside 	 5659E	
	Oval cylinder inside 	 5759E	
	Oval thumbturn cylinder 03 		







Narrow profile lock, hook bolt	Cylinder type	Security accessories	Security strike plate
 411-35	Oval double cylinder 	 4559E	 1487-9
	Oval cylinder outside 	 4659E	
	Oval cylinder inside 	 4759E	
	Oval thumbturn cylinder 03 		









Accessories, narrow profile locks



Choose your lock accessories in accordance with existing design, security and functional requirements.

The following matrices display products related to commonly found mechanical lock units.

Cylinder sash lock	Cylinder type	Cylinder accessories	Strike plate
 230-35	Oval double cylinder 	 44459E	 1264
	Oval cylinder outside 	 44859E	
	Oval cylinder inside 		

Double sash lock	Cylinder type	Cylinder accessories	Strike plate
 220-35	Oval double cylinder 	 55459	 1264
	Oval cylinder outside 	 55859	
	Oval cylinder inside 	 55159	

Lever handle sash lock	Cylinder accessories	Strike plate
 212-35	 55059	 1264



Strike plate matrix, Connect

The matrix below should be seen as a guideline when choosing which type of strike plate to choose. Door frame design, type and dimensions must all be accounted for in order to guarantee a smooth and safe correlation between the lock case and the strike plate.

A security strike plate is always recommended when a higher level of resistance to forced entry is desired.

- = ASSA recommends
- = Alternative strike plate

Lock case	Security strike plate					Strike plate		
	1487-1, 5	1487-8	1487-9	1487-11, 13	1489-11, 12	1264	1266	2887
212, 220, 221, 222, 223, 230, 231, 232	■					●		
310	■					●		
311			■			●		●
313							●	
340	■					●		
410, 411, 415	●		●	●	●			
2002	●			●	●			
620, 621, 622, 624, 640	■					●		
710, 711	●		●	●	●			
721, 722, 727, 732	■					●		
761, 762, 767, 772	■							
810, 811-50/70	●							
811-35		●						
880, 881, 884, 885	■					●		

Strike plate matrix, modular locks

The matrix below should be considered as a guide in the selection of strike plate type.

Door frame design, type and dimensions must all be accounted for in order to guarantee a smooth and safe correlation between the lock case and the strike plate.

A security strike plate is always recommended when a higher level of resistance to forced entry is desired.

- = ASSA recommends
- = For use with dead latch striker 1893
- = Alternative strike plate

		Security strike plate					Strike plate											
		1887-1-5	1887-9	1888	1889-11, -12	1824	2865	2860	2863	2862	2864	2866	2885	2888	2887	2876	2892	
Modular locks	560, 562, 564, 1560	●					●	●	●	●	●							
	5584, 5585, 6580, 6585, 8561, 8562	●					●	●	●	●	●		●					
	1498, 6498						●	●	●	●	●		●					
	565, 2565	■					●	●	●	●	●							
	566											●						
	587	●																
	2587	●	■													●		
	2000, 8765, 8768	●				●												
	9788	●			■	●												
	7787	●				●												
	9787	●	■			●												
	Narrow profile locks	1362	●					●	●	●	●	●						
1380, 1385, 13585, 1361		●					●	●	●	●	●		●					
1398		●					●	●	●	●	●		●					
13787		■	●															
Extra locks	8788	■		●										■				
	585, 2580	■					●	●	●	●	●		●					
Cabinet locks	576, 577																●	
	1592, 2592																	●



Microswitch functions, Connect

Microswitch functions	
MA	Alarm circuit and alarm by-pass
Lock case 310, 311, 410, 411, 640	Two microswitches Sw 1 active when hook bolt is withdrawn. Sw 2 active when hook bolt is thrown and deadlocked.
MB	Alarm circuit and alarm by-pass
Lock case 2002	Two microswitches Sw 1 active when hook bolt is thrown and deadlocked. Sw 2 active when thumbturn is disabled by snib.
MC	Deadlocking and cylinder/turn and handle
Lock case 620, 621, 622, 624, 636	Three microswitches Sw 1 active when latch is deadlocked. Sw 2 active when cylinder, turn or handle* is used. Sw 3 active when handle* is used. * Only the inside handle on the split-spindle variants.
ME	Alarm circuit and escape function
Lock case 710, 711	Two microswitches Sw 1 active when hook bolt is thrown and deadlocked. Sw 2 active when the handle of the emergency exit is used.
MF	Deadlocking and cylinder/turn
Lock case 220, 221, 222, 230, 231, 232	Two microswitches Sw 1 active when latch is deadlocked. Sw 2 active when cylinder or turn is used.
MG /MJ	Deadlocking and cylinder/turn and escape function
Lock case 721, 722, 732/761, 762, 772	Three microswitches Sw 1 active when latch is deadlocked. Sw 2 active when cylinder or turn is used. Sw 3 active when the handle of the emergency exit is used.
MK/MI	Deadlocking/Lockback and escape function
Lock case 727/767	Three microswitches Sw 1 active when latch is deadlocked. Sw 2 active when cylinder latch is locked back. Sw 3 active when the handle of the emergency exit is used.

Microswitch functions, modular locks

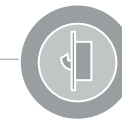

Application	Microswitch function	Lock case	Narrow profile	Extra
Alarm by-pass and indication, Model M2.	Two microswitches. One has a bistable function and is depressed when bolt is in withdrawn position. Changes when bolt leaves withdrawn position. The other has a momentary function. Indicates use of exit. Is depressed and changes in operation. Returns when thumbturn is released.	8768		
Alarm by-pass and alarm circuit, Model M3.	Bistable function. Two microswitches. One is depressed at unthrown bolt. The other is pushed in at thrown and deadlocked bolt.	8765, 9788 7787, 9787		8788
Alarm circuit, Model M4.	Bistable function. Microswitch depressed at thrown bolt. Changes when bolt leaves extended position.		13787	
Indication, Model M6.	Momentary function. Microswitch depressed and changed when opening with key or thumbturn.	560, 562, 564 1560, 5584 5585, 6580 6585		
Indication, Model M7.	Momentary function. Microswitch indicates movements of the emergency exit accessory. Microswitch depressed and changed when emergency exit accessory is used. Returns when thumbturn is released.	8768 8561, 8562	1361	
Indication, Model M8.	Momentary function. Microswitch indicates use of exit, key or thumbturn. Is depressed and changed in operation.	8561, 8562		
Indication, Model M9.	Momentary function. Microswitch indicates position of the cylinder latch. Is depressed and changed in operation.	560, 562, 564 1560, 5584 5585, 6585 8561, 8562		
Indication, Model M13.	Bistable function. Two microswitches. One is depressed at unthrown bolt. The second is depressed when thumbturn is disabled.	2000		



Microswitch functions, Connect

MA									
Hook bolt thrown - hook bolt withdrawn									
Lock case	Contact 1 Blue - White - Red			Contact 2 Green - Black - Yellow			Contact 3 Brown - Orange - Grey		
310, 311, 410, 411, 640	Hook bolt thrown	Blue	Hook bolt thrown (deadlocked)	Hook Bolt withdrawn	Green	Hook bolt withdrawn		Brown	
		White	Common		Black	Common		Orange	
		Red	Hook bolt withdrawn (not deadlocked)		Yellow	Hook bolt not withdrawn		Gray	
MB									
Hook bolt thrown - away secure									
Lock case	Contact 1 Blue - White - Red			Contact 2 Green - Black - Yellow			Contact 3 Brown - Orange - Grey		
2002	Hook bolt thrown	Blue	Hook bolt thrown (deadlocked)	Away secure snib	Green	Away secure		Brown	
		White	Common		Black	Common		Orange	
		Red	Hook bolt withdrawn (not deadlocked)		Yellow	Not away secure		Gray	
MC									
Deadlocking - cylinder/thumbturn - lever handle									
Lock case	Contact 1 Blue - White - Red			Contact 2 Green - Black - Yellow			Contact 3 Brown - Orange - Grey		
620, 621, 622, 624, 636	Dead-locking	Blue	Deadlocked	Cylinder follower	Green	Cyl/thumbturn/handle in motion	Inside lever handle	Brown	Handle in motion
		White	Common		Black	Common		Orange	Common
		Red	Not deadlocked		Yellow	Cyl/thumbturn/handle at rest		Gray	Handle at rest
234, 235, 236	Dead-locking	Blue	Deadlocked	Cylinder follower	Green	Cyl/thumbturn/handle in motion	Lever handle	Brown	Handle in motion
		White	Common		Black	Common		Orange	Common
		Red	Not deadlocked		Yellow	Cyl/thumbturn/handle at rest		Gray	Handle at rest
ME									
Hook bolt thrown - escape function									
Lock case	Contact 1 Blue - White - Red			Contact 2 Green - Black - Yellow			Contact 3 Brown - Orange - Grey		
710, 711		Blue	Hook bolt thrown (deadlocked)		Green		Escape function	Brown	Emergency exit is used
		White	Common		Black			Orange	Common
		Red	Hook bolt withdrawn (not deadlocked)		Yellow			Gray	Emergency exit at rest
MF									
Deadlocking - cylinder/thumbturn									
Lock case	Contact 1 Blue - White - Red			Contact 2 Green - Black - Yellow			Contact 3 Brown - Orange - Grey		
220, 221, 222, 230, 231, 232	Dead-locking	Blue	Deadlocked	Cylinder follower	Green	Cyl/thumbturn/handle at rest	Escape function	Brown	
		White	Common		Black	Common		Orange	
		Red	Not deadlocked		Yellow	Cyl/thumbturn in motion		Gray	

Microswitch functions, Connect



MG									
Deadlocking - cylinder - escape function									
Lock case	Contact 1 Blue - White - Red			Contact 2 Green - Black - Yellow			Contact 3 Brown - Orange - Grey		
721, 722, 732	Dead-locking	Blue	Deadlocked	Cylinder follower	Green	Cylinder at rest	Escape function	Brown	Emergency exit is used
		White	Common		Black	Common		Orange	Common
		Red	Not deadlocked		Yellow	Cylinder in motion		Gray	Emergency exit at rest
MI									
Deadlocking - lock-back - escape function									
Lock case	Contact 1 Green - Red - Yellow			Contact 2 Green - Black - Yellow			Contact 3 Brown - Orange - Grey		
767	Dead-locking	Green	Deadlocked	Lock-back function	Green	Not locked back	Escape function	Brown	Emergency exit is used
		Red	Common		Black	Common		Orange	Common
		Yellow	Not deadlocked		Yellow	Locked back		Gray	Emergency exit at rest
MJ									
Deadlocking - cylinder - escape function									
Lock case	Contact 1 Green - Red - Yellow			Contact 2 Green - Black - Yellow			Contact 3 Brown - Orange - Grey		
761, 762, 772	Dead-locking	Green	Deadlocked	Cylinder follower	Green	Cylinder at rest	Escape function	Brown	Emergency exit is used
		Red	Common		Black	Common		Orange	Common
		Yellow	Not deadlocked		Yellow	Cylinder in motion		Gray	Emergency exit at rest
MK									
Deadlocking - lock-back - escape function									
Lock case	Contact 1 Blue - White - Red			Contact 2 Green - Black - Yellow			Contact 3 Brown - Orange - Grey		
727	Dead-locking	Blue	Deadlocked	Lock-back function	Green	Not locked back	Escape function	Brown	Emergency exit is used
		White	Common		Black	Common		Orange	Common
		Red	Not deadlocked		Yellow	Locked back		Gray	Emergency exit at rest



Entrance and perimeter protection

Lock case for entrance, perimeter protection and other important doors. Complies with EN 12209 security grade 5.

Lock case	Application	Exterior function	Inside function
ASSA 2002-50 2002-70	Lock case for entrance doors in residential buildings, such as houses, apartments, apartment buildings for the elderly or disabled, etc.	A 360° turn of the key revokes the deadlock, places the hook bolt in the thrown or withdrawn position and automatically re-engages the thumbturn function. Lever handle retracts the latch bolt.	A 95° turn of the thumbturn revokes the deadlock and places the hook bolt in the thrown or withdrawn position when enabled. The button in the faceplate blocks and disables the thumbturn function. Lever handle retracts the latch bolt.
ASSA 410-50 410-70 410-35	Lock case for entrance doors, archive, store rooms, office premises, industries, etc.	A 360° turn of the key revokes the deadlock and places the hook bolt in the thrown or withdrawn position.	A 360° turn of the key revokes the deadlock and places the hook bolt in the thrown or withdrawn position. Lever handle retracts the latch bolt.
ASSA 411-50 411-70 411-35	Lock case for entrance doors, and sliding and swing doors equipped with a pull handle or a push plate.	A 360° turn of the key revokes the deadlock and places the hook bolt in the thrown or withdrawn position.	A 360° turn of the key revokes the deadlock and places the hook bolt in the thrown or withdrawn position.
ASSA 415-50	Lock case where two separate lock systems are able to open the same lock independently of each other.	The hook bolt retracts with a key through one of the two external cylinders.	The hook bolt retracts with a key through one of the two interior cylinders.



Entrance and interior doors

Lock case for entrance and interior doors where the requirements of burglary resistance are subordinate to the function. Complies with EN 12209 security grade 3.

Lock case	Application	Exterior function	Inside function
ASSA 310-50 310-70 310-35	Lock case for interior doors in offices, industries, toilet doors etc.	A 90° turn of the key revokes the deadlock and places the hook bolt in the thrown or withdrawn position. When the hook bolt is in the withdrawn position, the key operates the latch bolt at 95°. Lever handle retracts the latch bolt.	A 90° turn of key revokes the deadlock and places the hook bolt in thrown or withdrawn position. When the hook bolt is in the withdrawn position, the key operates the latch bolt at 95°. Lever handle retracts the latch bolt.
ASSA 311-50 311-70 311-35	Lock case for sliding and swing doors equipped with a pull handle or a push plate.	A 90° turn of the key revokes the deadlock and places the hook bolt in the thrown or withdrawn position.	A 90° turn of the key revokes the deadlock and places the hook bolt in the thrown or withdrawn position.
ASSA 313-50 313-70 313-35	Lock case for interior doors, push and swing doors, shops and entrance doors etc.	A 90° turn of the key revokes the deadlock and places the hook bolt in the thrown or withdrawn position. The doorknob is fixed.	A 90° turn of the thumbturn revokes the deadlock and places the hook bolt in the thrown or withdrawn position. The doorknob is fixed.



Entrance and interior doors

Lock case for entrance and interior doors where the requirements of burglary resistance subordinate the function.

Lock case	Application	Exterior function	Inside function
ASSA 220-50 220-70 220-35	Lock case for exterior and interior doors, entrance doors, technical areas etc.	A 90° turn of the key revokes the deadlock and retracts the latch bolt. Lever handle retracts the latch bolt.	A 90° turn of the thumbturn revokes the deadlock and retracts the latch bolt. Lever handle retracts the latch bolt. Cylinder latch is locked back with the snib.
ASSA 221-50 221-70 221-35	Lock case for exterior and interior doors, entrance doors, fire doors, technical areas etc.	A 90° turn of the key revokes the deadlock and retracts the latch bolt. Lever handle retracts the latch bolt.	A 90° turn of the thumbturn revokes the deadlock and retracts the latch bolt. Lever handle retracts the latch bolt. Cylinder latch is locked back with a token key.
ASSA 222-50 222-35	Lock case for exterior and interior doors, entrance doors, fire doors, technical areas etc.	A 90° turn of the key revokes the deadlock and retracts the latch bolt. Lever handle retracts the latch bolt.	A 90° turn of the thumbturn revokes the deadlock and retracts the latch bolt. Lever handle retracts the latch bolt. Cylinder latch cannot be locked back.
ASSA 223-50 223-35	Lock case for exterior and interior doors, entrance doors, fire doors, technical areas etc.	A 90° turn of the key revokes the deadlock and retracts the latch bolt. Lever handle retracts the latch bolt.	A 90° turn of the thumbturn revokes the deadlock and retracts the the latch bolt. Lever handle retracts latch bolt. The cylinder latch is locked back with a snib equipped with a locking nut. The snib can be secured in locked-back or normal position.



Entrance and interior doors

Lock case for entrance and interior doors where burglary resistance requirements subordinate function.

Lock case	Application	Exterior function	Inside function
ASSA 230-50 230-70 230-35	Lock case for entrance doors and gates with pull handles, door closers or door automatics.	A 90° turn of the key revokes the deadlock and retracts the latch bolt.	A 90° turn of the thumbturn revokes the deadlock and retracts the latch bolt. Cylinder latch is locked back with the snib.
ASSA 231-50 231-70 231-35	Lock case for entrance doors and gates with pull handles, door closers or door automatics.	A 90° turn of the key revokes the deadlock and retracts the latch bolt.	A 90° turn of the thumbturn revokes the deadlock and retracts the latch bolt. Cylinder latch is locked back with a token key.
ASSA 232-50 232-70 232-35	Lock case for entrance doors and gates with pull handles, door closers or door automatics.	A 90° turn of the key revokes the deadlock and retracts the latch bolt.	A 90° turn of the thumbturn revokes the deadlock and retracts the latch bolt.



Split spindle

Lock case for entrance and interior doors with a split spindle function.

Lock case	Application	Exterior function	Inside function
ASSA 620-50 620-70 620-35	Lock case for interior doors, class rooms, offices, technical areas, etc., where quick and convenient exiting is important.	A 90° turn of the key revokes the deadlock and retracts the latch bolt. Lever handle retracts the latch bolt.	Lever handle retracts both the latch bolt and the cylinder latch. Cylinder latch is locked back with the snib.
ASSA 621-50 621-70 621-35	Lock case for interior doors, class rooms, offices, technical areas, etc., where quick and convenient exiting is important.	A 90° turn of the key revokes the deadlock and retracts the latch bolt. Lever handle retracts the latch bolt.	Lever handle retracts both the latch bolt and the cylinder latch. Cylinder latch is locked back with a token key.
ASSA 622-50 622-70 622-35	Lock case for interior doors, class rooms, offices, technical areas, etc., where quick and convenient exiting is important.	A 90° turn of key revokes the deadlock and retracts the latch bolt. Lever handle retracts latch bolt.	Lever handle retracts both latch bolt and cylinder latch. Cylinder latch can not be locked back.
ASSA 624-50 624-70 624-35	Lock case for interior doors, class rooms, offices, technical areas, etc., where quick and convenient exiting is important.	A 90° turn of the key revokes the deadlock and retracts the latch bolt. Lever handle retracts the latch bolt.	Lever handle retracts both the latch bolt and the cylinder latch. Cylinder latch is locked back with the inside thumbturn.
ASSA 640-50 640-70 640-35	Lock case for interior doors, class rooms, offices, technical areas, hotel rooms, etc., with higher requirements of burglary resistance and where quick and convenient exiting is important.	A 90° turn of the key revokes the deadlock and retracts the hook bolt and the latch bolt. Lever handle retracts the latch bolt.	Lever handle retracts both the hook bolt and the latch bolt.



Entrance and perimeter protection

Lock case for entrance, perimeter protection and other important doors. Complies with EN 12209 security grade 5, to combine with LS 12209 security grade 5.

Lock case	Application	Exterior function	Inside function
ASSA 2000-50	Lock case for entrance doors in residential buildings, such as houses, apartments, apartment buildings for the elderly or disabled, etc.	A 360° turn of the key revokes the deadlock, places the bolt in the thrown or withdrawn position and automatically re-engages the thumbturn function. Lever handle retracts the latch bolt.	A 95° turn of the thumbturn revokes the deadlock and places the bolt in the thrown or withdrawn position when enabled. The button in the faceplate blocks and disables the thumbturn function. Lever handle retracts the latch bolt. Key operation as per the cylinder side.
ASSA 7787-50	Lock cases for entrance doors, archives, store rooms, office premises, industrial premises, etc.	A 360° turn of the key revokes the deadlock and places the hook bolt in the thrown or withdrawn position. Lever handle retracts the latch bolt.	A 360° turn of the key revokes the deadlock and places the hook bolt in the thrown or withdrawn position. Lever handle retracts the latch bolt.
ASSA 8765-50 8765-70	Lock cases for entrance doors, archive, store rooms, office premises, industrial premises, etc.	A 360° turn of the key revokes the deadlock and places the bolt in the thrown or withdrawn position.	A 360° turn of the key revokes the deadlock and places the bolt in the thrown or withdrawn position.
ASSA 9787-50	Lock case for entrance doors, and sliding and swing doors equipped with a pull handle or a push plate.	A 360° turn of the key revokes the deadlock and places the hook bolt in the thrown or withdrawn position.	A 360° turn of the key revokes the deadlock and places the hook bolt in the thrown or withdrawn position.
ASSA 9788-50 9788-70	Lock case for entrance doors, and sliding and swing doors equipped with a pull handle or a push plate.	A 360° turn of the key revokes the deadlock and places the bolt in the thrown or withdrawn position.	A 360° turn of the key revokes the deadlock and places the bolt in the thrown or withdrawn position.



Entrance and interior doors

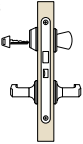
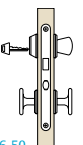
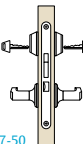
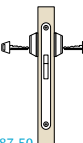
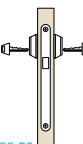

Lock case for entrance and interior doors where the requirements of burglary resistance are subordinate the function. Complies with EN 12209 security grade 3.

Lock case	Application	Exterior function	Inside function
ASSA 565-50 565-70	Lock case for interior doors in office and industrial premises, wash-room doors, etc.	A 90° turn of the key revokes the deadlock and places the bolt in the thrown or withdrawn position. When the bolt is in the withdrawn position, the key operates the latch bolt at 95°. Lever handle retracts the latch bolt.  565-50	A 90° turn of the thumbturn revokes the deadlock and places the bolt in the thrown or withdrawn position. When bolt is in withdrawn position thumbturn operates the latch bolt at 95°. Lever handle retracts the latch bolt.
ASSA 566-50	Lock case for interior doors, push and swing doors, shops and entrance doors, etc.	A 95° turn of the key revokes the deadlock and places the bolt in the thrown or withdrawn position. The doorknob is fixed.  566-50	A 95° turn of the thumbturn revokes the deadlock and places the bolt in the thrown or withdrawn position. The doorknob is fixed.
ASSA 587-50	Lock case for interior doors in industrial premises, shops, etc.	An 85° turn of the key revokes the deadlock and places the hook bolt in the thrown or withdrawn position. Lever handle retracts the latch bolt.  587-50	An 85° turn of the key revokes the deadlock and places the hook bolt in the thrown or withdrawn position. Lever handle retracts the latch bolt.
ASSA 2587-50	Lock case for entrance doors, and sliding and swing doors equipped with a pull handle or a push plate.	An 85° turn of the key revokes the deadlock and places the hook bolt in the thrown or withdrawn position.  2587-50	An 85° turn of the key revokes the deadlock and places the hook bolt in the thrown or withdrawn position.
ASSA 2588-50 2588-70	Lock case for entrance doors and swing doors equipped with a pull handle or a push plate.	A 90° turn of the key revokes the deadlock and places the bolt in the thrown or withdrawn position.  2588-50	A 90° turn of the key revokes the deadlock and places the bolt in the thrown or withdrawn position.

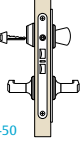

Entrance and interior doors

Lock case for entrance and interior doors where the requirements of burglary resistance subordinate function.

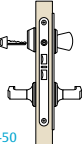
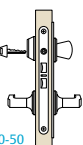
Lock case	Application	Exterior function	Inside function
ASSA 560-50 560-70	Lock case for exterior and interior doors, entrance doors to technical areas, etc.	A 75° turn of the key revokes the deadlock and retracts the latch bolt. Lever handle retracts the latch bolt.  560-50	A 75° turn of the thumbturn revokes the deadlock and retracts the latch bolt. Lever handle retracts the latch bolt. Cylinder latch is locked back with the snib.
ASSA 562-50	Lock case for exterior and interior doors, entrance doors to technical areas, etc.	A 75° turn of the key revokes the deadlock and retracts the latch bolt. Lever handle retracts the latch bolt.  562-50	A 75° turn of the thumbturn revokes the deadlock and retracts the latch bolt. Lever handle retracts the latch bolt. Cylinder latch is locked back with a token key.
ASSA 564-50	Lock case for exterior and interior doors, entrance doors to technical areas, etc.	A 75° turn of the key revokes the deadlock and retracts the latch bolt. Lever handle retracts the latch bolt.  564-50	A 75° turn of the thumbturn revokes the deadlock and retracts the latch bolt. Lever handle retracts the latch bolt. The cylinder latch is locked back with the snib, which is equipped with a locking nut. The snib can be secured in locked-back or normal position.
ASSA 1560-50 1560-70	Lock case for exterior and interior doors, entrance doors to technical areas, etc.	A 75° turn of the key revokes the deadlock and retracts the latch bolts. Lever handle retracts the latch bolt.  1560-50	A 75° turn of the thumbturn revokes the deadlock and retracts the latch bolt. Lever handle retracts the latch bolt. Cylinder latch cannot be locked back.





Lock cases

Lock cases

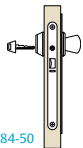
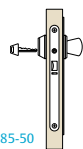

Entrance and interior doors





Lock case for entrance and interior doors where the requirements of burglary resistance subordinate function.

Lock case	Application	Exterior function		Inside function
ASSA 5584-50	Lock case for entrance doors and gates with pull handles, door closers or door automatics.	A 75° turn of the key revokes the deadlock and retracts the latch bolt.		A 75° turn of the thumbturn revokes the deadlock and retracts the latch bolt. Cylinder latch is locked back with the snib.
ASSA 5585-50 5585-70	Lock case for entrance doors and gates with pull handles, door closers or door automatics.	A 75° turn of the key revokes the deadlock and retracts the latch bolt.		A 75° turn of the thumbturn revokes the deadlock and retracts the latch bolt. Cylinder latch is locked back with a token key.
ASSA 6580-50 6580-70	Lock case for interior doors with pull handles, door closers or door automatics.	A 75° turn of the key retracts the latch bolt.		A 75° turn of the thumbturn retracts the latch bolt. Cylinder latch is locked back with a token key.
ASSA 6585-50	Lock case for entrance doors and gates with pull handles, door closers or door automatics.	A 75° turn of the key revokes the deadlock and retracts the latch bolt.		A 75° turn of the thumbturn revokes the deadlock and retracts the latch bolt.
ASSA 5761-50	Lock case where two separate lock systems are able to open the same lock independently of each other.	Cylinder latch retracts with a key through one of the two external cylinders.		Cylinder latch retracts with a key through one of the two external cylinders, or, if desired, a lever handle.



Split spindle

Lock case for entrance and interior doors with a split spindle function.

Lock case	Application	Exterior function		Inside function
ASSA 504-50	Lock case for interior doors, class rooms, offices, technical areas, etc., where quick and convenient exiting is important.	A 90° turn of the key revokes the deadlock and retracts the latch bolt. Lever handle retracts the latch bolt.		Lever handle retracts both latch bolt and the cylinder latch. Cylinder latch is locked back with the snib.
ASSA 506-50	Lock case for interior doors, class rooms, offices, technical areas, etc., where quick and convenient exiting is important.	A 90° turn of the key revokes the deadlock and retracts the latch bolt. Lever handle retracts the latch bolt.		Lever handle retracts both the latch bolt and the cylinder latch. Cylinder latch is locked back with a token key.
ASSA 509-50	Lock case for interior doors, class rooms, offices, technical areas, etc., where quick and convenient exiting is important.	A 90° turn of the key revokes the deadlock and retracts the latch bolt. Lever handle retracts the latch bolt.		Lever handle retracts both the latch bolt and the cylinder latch. Cylinder latch is locked back with the inside thumbturn.
ASSA 1520-50	Lock case for interior doors, class rooms, offices, technical areas, hotel rooms, etc., with higher burglary resistance requirements and where quick and convenient exiting is important.	A 90° turn of the key revokes the deadlock and retracts the bolt and the latch bolt. Lever handle retracts the latch bolt.		Lever handle retracts both the bolt and the latch bolt.



Narrow profile lock

Lock case for entrance, perimeter protection and other important doors with a narrow profile design. Complies with EN 12209 security grade 4.

Lock case	Application	Exterior function	Inside function
ASSA 13787	Lock case for entrance doors in shops, department stores, offices, etc.	A 360° turn of the key revokes the deadlock and places the hook bolt in the thrown or withdrawn position.	A 360° turn of the key revokes the deadlock and places the hook bolt in and thrown or withdrawn position.

13787-28

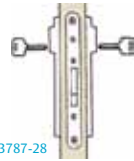

Narrow profile lock

Lock case for interior and entrance doors with a narrow profile design.

Lock case	Application	Exterior function	Inside function
ASSA 1362	Lock case for entrance doors and gates in shops, apartment blocks, etc.	A 90° turn of the key revokes the deadlock and retracts the latch bolt. Lever handle retracts the latch bolt.	A 90° turn of the thumbturn revokes the deadlock and retracts the latch bolt. Lever handle retracts the latch bolt. Cylinder latch is locked back with a token key.
ASSA 1380	Lock case for interior doors with pull handles, door closers or door automatics in shops, department stores, offices, apartment blocks, etc.	A 90° turn of the key retracts the latch bolt.	A 90° turn of the thumbturn retracts the latch bolt. Lever handle retracts the latch bolt. Cylinder latch is locked back with a token key.
ASSA 1385	Lock case for entrance doors and gates with pull handles, door closers or door automatics in shops, department stores, offices, apartment blocks, etc.	A 90° turn of the key revokes the deadlock and retracts the latch bolt.	A 90° turn of the thumbturn revokes the deadlock and retracts the latch bolt. Cylinder latch is locked back with a token key.
ASSA 13585	Lock case for entrance doors and gates with pull handles, door closers or door automatics in shops, department stores, offices, apartment blocks, etc.	A 90° turn of the key revokes the deadlock and retracts the latch bolt.	A 90° turn of the thumbturn revokes the deadlock and retracts the latch bolt. Cylinder latch cannot be locked back.

1362-28

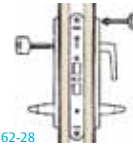

1380-28

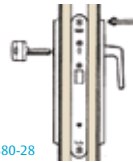

1385-28

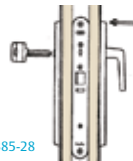

13585-28

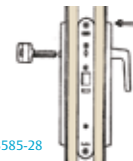



All Connect lock cases with a lever handle latch and/or no lockable cylinder latch are CE-marked and approved for installation in doors made of timber, aluminium and steel in fire grading E/EI15 - E/EI 60. CE-certificate 1162-CPD-0233.

Environment

This product is designed to have minimal impact on the environment over its lifecycle. It is recycled as scrap metal. Any microswitches are separated out and recycled as electronic waste.

Latch hook bolt lock 2002

Application

Lock case for entrance doors in the residential segment, such as houses, apartments, apartment buildings for the elderly and disabled, etc.

Features

- Available with backset 50 or 70 mm
- Meets the requirements of EN 12209 security grade 5
- CE-certified
- With lever latch and hook bolt
- Lock-back device for thumbturn in the forend
- Guided hook bolt of hardened steel
- The hook bolt interlocks door and frame
- Reinforced deadlocking
- Handing of lever latch is reversible
- Hardened steel lever latch for fire-rated doors
- Available with a built-in microswitch
- Used with ASSA security strike plate 1487-1-5 or 1489-11, -13
- Lock shield included

Function

- The hook bolt is operated with a key or thumb turn cylinder with built-in magnetic return mechanism
- When the snib is pressed down, the thumbturn function is blocked so that the lock cannot be opened without the key = away secure
- When the lock is opened with the key, the thumb turn function is automatically activated = home convenient
- The lever latch is retracted with the handle
- The 2002 series is designed to meet highest security requirements, for which a double cylinder is part of the specification. For this reason we do not recommend using the thumbturn.



2002-50



Latch hook bolt lock 410

Application

Lock case for entrance doors, archives, storage areas, offices, industrial buildings, etc.

Features

- Available with backset 35, 50 or 70 mm
- Meets the requirements of EN 12209 security grade 5
- CE-certified
- With lever latch and hook bolt
- Guided hook bolt of hardened steel
- Reinforced deadlocking
- Hook bolt interlocks the door and the frame
- Handing of lever latch is reversible
- Hardened steel lever latch for fire-rated doors
- Available with a built-in microswitch
- Used with ASSA security strike plate 1487-1-5 or 1489-11, -13
- Lock shield included

Function

- The hook bolt is operated with a key or the thumbturn cylinder with built-in magnetic return mechanism
- The lever latch is retracted with the handle
- Designed to meet highest security requirements where a double cylinder is part of the specification. For this reason ASSA do not recommend using the thumbturn.

Hook bolt lock 411

Application

Lock case for entrance doors, and sliding and swing doors equipped with a pull handle or a push plate.

Features

- Available with backset 35, 50 or 70 mm
- Meets the requirements of EN 12209 security grade 5
- Guided hook bolt of hardened steel
- Reinforced deadlocking
- Hook bolt interlocks the door and the frame
- Available with a built-in microswitch
- Used with ASSA security strike plate 1487-1-5 or 1489-11, -13
- Lock shield included

Function

- The hook bolt is operated with a key or the thumbturn cylinder with built-in magnetic return mechanism
- Designed to meet highest security requirements where a double cylinder is part of the specification. For this reason ASSA do not recommend using the thumbturn.



410-50

411-50



Two cylinder lock 415-50

Application
Lock case for entrance, basement and storage area doors with a pull handle or a push plate.

- Features**
- Available with backset 50 mm
 - With guided hook bolt of hardened steel
 - Compatible with ASSA accessories for round cylinders
 - Recommended pull handle: ASSA 5420
 - To be used with security strikes 1487-1-5 or 1489-11, -13

- Function**
- Outside/Inside
 - The hook bolt is retracted with the key using one of the two cylinders



415-50

Latch hook bolt lock 310

Application
Lock case for interior doors in industrial buildings, shops, etc.

- Features**
- Available with backset 35, 50 or 70 mm
 - With hook bolt and lever latch
 - Handing of the lever latch is reversible
 - Lever latch of hardened steel for fire-rated doors
 - Hook bolt interlocks the door and the frame
 - CE-certified
 - Used with ASSA strike plate 1264-1-8

- Function**
- Hook bolt is operated with the key or the thumb turn
 - Lever latch is retracted with the lever handle or the key



310-50

Hook bolt lock 311

Application
Lock case for interior doors in industrial buildings and shops, in sliding doors, swing doors, etc.

- Features**
- Available with backset 35, 50 or 70 mm
 - With hook bolt
 - Hook bolt interlocks the door and the frame

- Function**
- Hook bolt is operated with the key or the thumb turn
 - Used with ASSA strike plate 1264-1-8



311-50



Hook bolt lock 313

Application
Lock case for interior doors, sliding and swing doors, shops and entrance doors etc.

- Features**
- Available with backset 35, 50 or 70 mm
 - With hook bolt and adjustable roller latch
 - Hook bolt interlocks the door and the frame
 - Combined with pull handle or push plate
 - Used with ASSA strike plate 1266

- Function**
- Hook bolt is operated with the key or the thumb turn
 - Roller latch is depressed by the strike plate



313-50

Connect 340

Application
Lock case for ASSA Smartair, used for interior doors in industrial buildings, offices, conference rooms, etc.

- Features**
- Available with backset 35, 50 or 70 mm
 - Complies with EN 12209 security grade 3
 - CE-certified
 - With deadlocking lever latch and hook bolt
 - Reversible latch bolt
 - Latch bolt deadlocks automatically when it is extracted 14 mm and the deadlocking latch is depressed
 - Hardened steel latchbolt for fire-rated doors
 - Used in combination with ASSA strike 1264

- Function**
- Inside
 - Hook bolt and latch bolt retracted by lever latch
 - Hook bolt is operated with thumbturn
 - Outside
 - Handle is not in action
 - At approved opening, both latch bolt and hook bolt retracted with lever latch
 - Hook bolt is locked out by key



340-50



Double latch locks 220, 221, 222, 223

Application

Double latch locks. Lock cases for exterior and interior doors, entrance doors, technical areas, etc.

Features

- Available with backset 35, 50 or 70 mm
- With cylinder, deadlocking and lever latch
- Cylinder latch deadlocks automatically when it is extracted 14 mm and the deadlocking latch is depressed
- Available with a built-in microswitch
- Cylinder latch can be locked back
- Handing of the latches is reversible
- Hardened steel lever latch for fire-rated doors
- Can be combined with electric strikes
- Used in combination with ASSA strike 1264-1-8
- All lock cases in the 220 series are CE-certified

Function

- Cylinder, deadlocking and lever latch are retracted with the key or the thumbturn
- Lever latch is retracted with lever handle

The lock-back mechanism in the faceplate has the following functions:

- 220 Cylinder latch is locked back with a snib
- 221 Cylinder latch is locked back with a token key
- 222 Cylinder latch cannot be locked back
- 223 Cylinder latch is locked back with snib equipped with a locking nut. The snib can be secured in locked-back or normal position.



Cylinder latch locks 230, 231, 232

Application

Cylinder latch lock. Lock cases for entrance doors and gates with pull handles, door closers or door automatics.

Features

- Available with backset 35, 50 or 70 mm
- With cylinder and deadlocking latch
- Automatic deadlocking of cylinder latch at 14 mm extraction and depressed deadlocking latch
- Available with a built-in microswitch
- Cylinder latch can be locked back
- Handing of the cylinder latch is reversible
- Can be combined with electric strikes
- Connect 232 is CE-certified
- Used in combination with ASSA strike plate 1264-1-8
- Hardened steel cylinder latch

Function

- Cylinder and deadlocking latch are retracted with the key or the thumbturn

The lock-back mechanism in the faceplate has the following functions:

- 230 Cylinder latch is locked back with a snib
- 231 Cylinder latch is locked back with a token key
- 232 Cylinder latch cannot be locked back



Lock cases

Lock cases



Latch lock 212

Application

Lock case for doors where only lever function is desired.

Features

- Available with backset 35, 50 or 70 mm
- With lever latch
- Handing of the lever latch is reversible
- Steel lever latch for fire-rated doors

Function

- Lever latch is retracted with lever handle



212-50

Latch hook bolt lock 640 with split spindle function

Application

Latch hook lock 640 with split spindle function. Lock case for class rooms, hotels, technical areas, offices, etc. where high security demands and quick and convenient exiting are top priorities.

Features

- Available with backset 35, 50 or 70 mm
- Complies with EN 12209 security grade 3
- With deadlocking lever latch and hook bolt
- Latch bolt deadlocks automatically when it is extracted 14 mm and the deadlocking latch is depressed
- Handing of the lever latch is reversible
- Can be mounted with or without outside handle
- Lever latch of hardened steel for fire-rated doors
- CE-certified
- Used in combination with ASSA security strike plate 1487-1-5

Function

- Outside
 - Deadbolt is operated with key
 - Lever latch is retracted with handle
- Inside
 - Deadbolt is operated with thumbturn
 - Lever latch and deadbolt are retracted with the lever handle



640-50



Double latch locks 620, 621, 622, 624 with split spindle function

Application

Double latch locks 620, 621, 622, 624 with split spindle function for interior doors, class rooms, offices, and technical areas etc. where quick and convenient exiting are important.

Features

- Available with backset 35, 50 or 70 mm
- With cylinder, deadlocking and lever latch
- Automatic deadlocking of cylinder latch at 14 mm extraction and depressed deadlocking latch
- Available with a built-in microswitch
- Cylinder latch can be locked in
- Handing of the latches is reversible
- Lever latch of hardened steel for fire-rated doors
- Can be combined with electric strikes
- CE-certified
- Complies with EN12209 security grade 2
- Can be combined with ASSA strike plate 1264-1-8

Function

- Outside
 - Cylinder, deadlocking and lever latch are retracted with the key
 - Lever latch is retracted with the lever handle
- Inside
 - Cylinder, deadlocking and lever latch are retracted with the lever handle

The lock-back mechanism in the faceplate has the following functions:

- 620 Cylinder latch is locked back with a snib
- 621 Cylinder latch is locked back with a token key
- 622 Cylinder latch cannot be locked back
- 624 Cylinder latch is locked back with the inside turn and thumbturn



620-35

621-35

622-35

624-35



All modular lock cases with lever handle latch and/ or no lockable cylinder latch are CE-marked and approved for installation in doors made of timber, aluminium and steel in fire grading E/EI 15 - E/EI 60. CE certificate 1162-CPD-0232.

Latch deadbolt lock 2000

Application

Lock case for entrance doors in residential segments, such as houses, apartments, apartment buildings for the elderly and disabled, etc.

Features

- Available with backset 50 mm
- Complies with EN 12209 security grade 5.
- With lever latch and deadbolt
- Blocking mechanism (snib) for thumbturn function in the faceplate
- Guided deadbolt of hardened steel
- Handing of the lever latch is reversible
- Lever latch of steel for fire-rated doors
- Available with a built-in microswitch
- Lock shield included
- CE-certified

Function

- Bolt is operated with the key or the thumbturn cylinder with built-in magnetic return mechanism
- When the snib is pressed down, the thumbturn function is blocked so that the lock cannot be opened without the key i.e. away secure
- When the lock is opened with the key, the thumbturn function is automatically activated i.e. home convenient
- Lock shield included
- Lever latch is retracted with the handle

Latch hook bolt lock 7787

Application

Lock case for entrance doors, archives, storage areas, offices, industrial buildings, etc.

Features

- Available with backset 50 mm
- Complies with EN 12209 security grade 5.
- With lever latch and hook bolt
- Guided hook bolt of hardened steel
- Hook bolt interlocks the door and the frame
- Handing of the lever latch is reversible
- Lever latch of steel for fire-rated doors
- Available with a built-in microswitch
- Lock shield included
- CE-certified

Function

- Hook bolt is operated with the key or the thumbturn cylinder with built-in magnetic return mechanism
- Lever latch is retracted with the handle



Environment

This product is designed to have minimal impact on the environment over its lifecycle. It is recycled as scrap metal. Any microswitches are separated out and recycled as electronic waste.



Latch deadbolt lock 8765

Application

Lock case for entrance doors, archives, storage areas, offices, industrial buildings, etc.

Features

- Available with backset 50 or 70 mm
- Complies with EN 12209 security grade 5
- With lever latch and deadbolt
- Guided deadbolt of hardened steel
- Handing of the lever latch is reversible
- Lever latch of steel for fire-rated doors
- Available with a built-in microswitch
- Lock shield included
- CE-certified

Function

- The deadbolt is operated with the key or the thumbturn cylinder with built-in magnetic return mechanism
- The lever latch is retracted with the handle



Hook bolt lock 9787

Application

Lock case for entrance doors, sliding and swing doors with a pull handle or a push plate.

Features

- Available with backset 50 mm
- Complies with EN 12209 security grade 5
- Guided hook bolt of hardened steel
- Hook bolt interlocks the door and the frame
- Available with a built-in microswitch

Function

- The hook bolt is operated with the key or the thumbturn cylinder with built-in magnetic return mechanism





Deadbolt locks 9788

Application

Lock case for entrance doors, sliding and swing doors with a pull handle or a push plate.

Features

- Available with backset 50 or 70 mm
- Complies with EN 12209 security grade 5
- Guided deadbolt of hardened steel
- Available with a built-in microswitch
- Lock shield included

Function

- The deadbolt is operated with the key or the thumbturn cylinder with built-in magnetic return mechanism



Latch deadbolt lock 565

Application

Lock case for exterior and interior doors, offices, industrial buildings, etc.

Features

- Available with backset 50 or 70 mm
- Complies with 12209 security grade 3
- With lever latch and deadbolt
- Handing of the lever latch is reversible
- Lock can be combined with a coordinated series of bathroom accessories
- CE-certified

Function

- The deadbolt is operated with the key or the thumbturn
- The lever latch is retracted with the handle, key or thumbturn



Roller latch lock with deadbolt 566

Application

Lock case for interior doors and swing doors, shop and entrance doors.

Features

- Available with backset 50 or 70 mm
- Complies with EN 12209 security grade 3
- With deadbolt and adjustable roller latch
- Combined with pull handle or push plate

Function

- The deadbolt is operated with the key or the thumbturn
- The roller latch is depressed by the strike plate



Hook bolt lock 587

Application

Lock case for interior doors in industrial buildings, shops, etc.

Features

- Available with backset 50 mm
- Complies with EN 12209 security grade 3
- With hook bolt and lever latch
- Hook bolt deadlocks automatically at 85° extraction
- Handing of the lever latch is reversible
- Lever latch of steel for fire-rated doors
- Hook bolt interlocks the door and the frame
- CE-certified

Function

- The hook bolt is operated with the key or the thumbturn
- The lever latch is retracted with handle





Hook bolt lock 2587

Application

Lock case for interior doors in industrial buildings, shops, sliding doors, swing doors, etc.

Features

- Available with backset 50 mm
- Complies with EN 12209 security grade 3
- With hook bolt
- Hook bolt interlocks the door and the frame

Function

The hook bolt is operated with key or thumbturn.



2587

3-point locks 2565, 6498

Application

Lock case for fire doors on boats and oil rigs.

Features

- Available with backset 50 or 70 mm
- With lever latch (6498)
- With deadbolt (2565)
- Handing of the lever latch with 16 mm extraction is reversible
- Lever latch of steel for fire-rated doors
- Can be connected with a linkage rod
- CE-certified

Function

- The deadbolt is operated with the key or the thumbturn
- The lever latch is retracted with the handle
- If the locks are connected according to the figure, all three locks will be operated through the 2565.



2565

6498

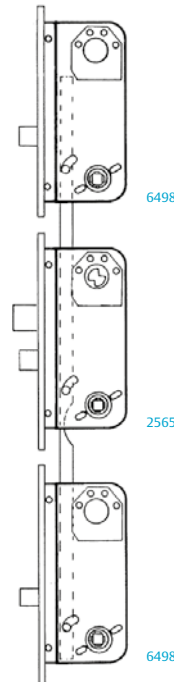

6498

2565

6498

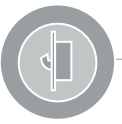

Deadbolt lock 2588

Application

Lock case for entrance doors, sliding and swing doors with a pull handle or a push plate.

Features

- Available with backset 50 mm
- Complies with EN 12209 security grade 3
- With deadbolt

Function

- The deadbolt is operated with the key or the thumbturn



2588



Double latch locks 560, 562, 564, 1560

Application

Lock case for exterior and interior doors, entrance doors, technical areas, etc.

Features

- Available with backset 50 or 70 mm
- With cylinder, deadlocking and lever latch
- Automatic deadlocking of cylinder latch at 14 mm extraction and depressed deadlocking latch
- Available with a built-in microswitch
- Cylinder latch can be locked back
- Handing of the latches is reversible
- Lever latch of steel for fire-rated doors
- Can be combined with electric strikes
- CE-certified

Function

- The cylinder, deadlocking and lever latch are retracted with the key or the thumbturn
- The lever latch is retracted with the handle

The lock-back mechanism in the faceplate has the following functions:

- 560 Cylinder latch is locked back with a snib
- 562 Cylinder latch is locked back with a token key
- 564 Cylinder latch is locked back with a snib equipped with a locking nut. The snib can be secured in locked-back or normal position
- 1560 Cylinder latch cannot be locked-back

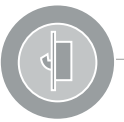

Cylinder latch locks 5584, 5585, 6580, 6585

Application

Lock case for entrance doors and gates with pull handles, door closers or door automatics.

Features

- Available with backset 50 or 70 mm
- With cylinder and deadlocking latch
- Automatic deadlocking of cylinder latch at 14 mm extraction and depressed deadlocking latch
- Available with a built-in microswitch
- Cylinder latch can be locked back
- Handing of the latches is reversible
- Can be combined with electric strikes

Function

- The cylinder and deadlocking latch are retracted with the key or the thumbturn

The lock-back mechanism in the faceplate has the following functions:

- 5584 Cylinder latch is locked back with snib
- 5585 Cylinder latch is locked back with a token key
- 6580 Without deadlocking function, the cylinder latch is locked back with a token key
- 6585 Cylinder latch cannot be locked back. CE-certified





Latch bolt locks 1498

Application

Lock case for doors where only lever handle function is desired.

Features

- Available with backset 50 or 70 mm
- With lever latch
- Handing of the lever latch is reversible
- Lever latch of steel for fire-rated doors
- CE-certified

Function

- The lever latch is retracted with the handle



Latch deadbolt lock 1520 with split spindle function

Application

Lock case for classrooms, hotel rooms, technical areas, offices, etc., with high burglary resistance requirements and where quick and convenient exiting is required.

Features

- Available with backset 50 or 70 mm
- Complies with EN 12209 security grade 3
- With deadlocking lever latch and bolt
- The lever latch deadlocks automatically when it is extracted 14 mm and the deadlocking latch is depressed
- Handing of the lever latch is reversible
- Can be mounted with or without outside handle
- CE-certified

Function

- Outside
 - The deadbolt is operated with the key
 - The lever latch is retracted with the handle
- Inside
 - The deadbolt is operated with the thumbturn
 - Lever latch and deadbolt are retracted with the lever handle



Double latch locks 504, 506, 509 with split spindle function

Application

Lock case for interior doors, offices, technical areas, etc. with high burglary resistance requirements and where quick and convenient exiting is required.

Features

- Available with backset 50 mm
- With cylinder, deadlocking and lever latch
- Cylinder latch deadlocks automatically when it is extracted 14 mm and the deadlocking latch is depressed
- The cylinder latch can be locked back
- Handing of the latches is reversible
- Lever latch of steel for fire-rated doors
- Can be combined with electric strikes
- CE-certified

Function

- Outside
 - Cylinder, deadlocking and lever latch are retracted with key
 - Lever latch is retracted with handle
- Inside
 - Cylinder, deadlocking and lever latch are retracted with the lever handle

Cylinder, deadlocking and lever latch are retracted with the lever handle

- 504 Cylinder latch is locked back with a snib
- 506 Cylinder latch is locked back with a token key
- 509 Cylinder latch is locked back with inside thumbturn





Double cylinder lock 5761

Application

Lock case for entrance, basement and storage area doors with a pull handle or a push plate.

Features

- Available with backset 50 mm
- With cylinder and deadlocking latch
- Automatic deadlocking of cylinder latch at 14 mm extraction and depressed deadlocking latch
- The cylinder latch can be locked back
- Handing of the latches is reversible
- Cylinder latch of steel for fire-rated doors
- Can be combined with ASSA accessory sets 5761-1 or 5761-3
- Can be combined with electric strikes

Function

- Outside
 - The cylinder latch is retracted with key using one of the two cylinders.
- Inside
 - The cylinder latch is retracted with the key using one of the cylinders (5761-3) or with the handle (5761-1).



5761



All narrow profile lock cases with lever handle latch and/or no lockable cylinder latch are approved for installation in doors made of timber, aluminium and steel in fire grading E/EI 15 - E/EI 60.

Hook bolt lock 13 787

Application

Lock case for entrance doors in shops, department stores, offices, etc. with narrow profile design. The lock is ideal for use in patio and balcony doors without an espagnolette.

Features

- Available with backset 28 mm
- Complies with EN 12209 security grade 4
- Guided hook bolt of hardened steel
- Hook bolt interlocks the door and the frame
- Available with a built-in microswitch

Function

- The hook bolt is operated with the key or the thumbturn



13 787

Double latch locks 1362

Application

Lock case for entrance doors in shops, offices, apartment buildings, etc. with narrow profile door design.

Features

- Available with backset 28 mm
- With cylinder, deadlocking and lever latch
- The cylinder latch deadlocks automatically when it is extracted 14 mm and the deadlocking latch is depressed
- The cylinder latch can be locked back
- Can be combined with electric strikes
- CE-certified

Function

- The cylinder and lever latch are retracted with the key or the thumbturn
- The lever latch is retracted with the handle
- The cylinder latch can be locked back with a token key



1362



Narrow profile locks

Cylinder latch locks 1380, 1385, 13 585

Application

Lock case for entrance doors in shops, department stores, offices, apartment buildings, etc. with narrow profile door design and with a pull handle and a door closer or door automatics.

Features

- Available with backset 28 mm
- With cylinder and deadlocking latch
- Cylinder latch deadlocks automatically when it is extracted 14 mm and the deadlocking latch is depressed
- Cylinder latch can be locked back
- Can be combined with electric strikes

Function

- The cylinder latch is retracted with the key or the thumbturn
 - 1380 Without deadlocking function. Cylinder latch is locked back with a token key.
 - 1385 Cylinder latch can be locked back with token key.
- - 13585 Cylinder latch cannot be locked back. CE-certified



1380

1385



13585



1398

Latch bolt locks 1398

Application

Lock case for interior doors and corridor doors with narrow profile design and when only handle function is desired.

Features

- Available with backset 28 mm
- With lever latch
- CE-certified

Function

- The lever latch is retracted with the handle

Auxiliary lock

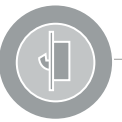

Auxiliary lock 8788

Application

Lock case for use as a supplementary lock in entrance doors, gates and swing doors.

Features

- Available with backset 50 mm
- Complies with EN 12209 security grade 5
- Guided deadbolt of hardened steel
- Available with a built-in microswitch
- Mortice lock that requires other door preparation than modular locks

Function

- The bolt is operated with the key or the thumb turn



8788

Cylinder latch locks 585, 2580

Application

Lock case for entrance doors and gates for retrofitting/aftermarket where modular locks cannot be installed.

Features

- Available with backset 50 mm
- With cylinder and deadlocking latch
- Cylinder latch can be locked back
- Can be combined with electric strikes
- Mortice lock that requires other door preparation than modular locks
 - 585 Cylinder latch deadlocks automatically when it is extracted 14 mm and the dead locking latch is depressed
 - 2580 Without deadlocking function

Function

- The cylinder latch is retracted with the key or the thumbturn
- The cylinder latch is locked back with a token key



585



2580



Surface-mounted locks

Latch lock 576

Application

Lock case for surface mounting in doors whose design does not allow mounting of modular locks.

Features

- With cylinder and deadlocking latch
- Reversible cylinder latch
- The cylinder latch deadlocks automatically when it is extracted 14 mm and the deadlocking latch is depressed
- The cylinder latch can be locked back

Function

- The cylinder latch is retracted with the key or the thumbturn
- The cylinder latch is locked back by depressing it in the lock case, and released with the thumbturn or the key



576

Deadbolt Lock 577

Application

Lock case for surface mounting in doors whose design does not allow mounting of modular locks.

Features

- With deadbolt
- The deadbolt is reinforced with hardened steel pins for increased protection against cutting

Function

- The bolt is operated with the key or the thumb turn



577

Cabinet locks



593, 1593, 2593, 3593

Application

Lock for cabinet doors, electric cabinets, etc.

Features

- Cabinet locks for construction cylinders
- Deadbolt equipped with an adjusting screw
- Deadbolt turn 90°
- Can be completed with an extension ring to suit other door thicknesses

Function

- The lock is operated with the key
- The key can only be removed in the locked position

Lock type	Door thickness, mm	Extension ring, mm
593	20 - 65	
1593	0 - 45	
2593	37 - 80	
3593	0 - 7	37
3593	7 - 12	30
3593	12 - 17	25
3593	17 - 22	20
3593	22 - 27	15
3593	27 - 32	10
3593	32 - 37	5



593



1593



2593, 3593

1592, 2592

Application

Locks for cabinet doors, hatches, etc.

Features

- For construction cylinders
- Can be fitted with an extension ring to suit other door thicknesses

Function

- Deadbolt or latch is operated with the key
- The key can be removed both in both the locked and unlocked position.
 - 1592 With latch
 - 2592 With deadbolt

Lock type	Door thickness, mm	Extension ring, mm
1592	20 - 60	
2592	20 - 60	
1592	10 - 20	10
2592	10 - 20	
1592	0 - 10	20
2592	0 - 10	



1592



2592



Blocking locks 530, 1530

Application

Lock for blocking electric main switches and fuse boxes. Prevents unauthorised persons from switching on the power and subsequently causing accidents.

Features

- Shackles of bright zinc steel
- For construction cylinders

Function

- The shackle is operated with key
 - 530 Single-secured
 - 1530 Multiple-secured: up to six persons can block the lock with another blocking lock or a padlock



530



1530

Medicine cabinet lock 1596

Application

Lock for medicine cabinets, refrigerators, etc.

Features

- For construction cylinders
- With latch and deadlocking latch
- An extension ring can be added when the door thickness is less than 22 mm
- The cylinder latch deadlocks automatically when it is extracted 10 mm and the deadlocking latch is depressed

Function

- The latch is retracted with the key
- The key can be removed in locked position only



1596



Security strike plates 1487

Application

For perimeter protection and other important doors, where security is of the essence.

Features

- Complies with EN 12209 security grade 5
- Mounted with high security screws to resist higher break force and for maximum resistance to attack.

Function

- For protection of the lock case deadbolt from physical attack and manipulation.
 - With edge-rolled front for low friction between strike plate and the latch.
- In model numbers 1487-1 – 1487-4, the lips in the security box are adjustable to ensure that the correct border pressure is achieved.



1487-1

1487-5

1487-9

Model	Width, (mm)	Lip, (mm)	Angle	Length, (mm)
1487-1	40	13,5		200
1487-2	40	16,5		200
1487-3	43,5	20		200
1487-4	45	21,5		200
1487-5	29,5	5,5	29,5	200
1487-9	25	5,5		245
1487-11	40	13,5-18,5		200
1487-12	43,5	17-22		200
1487-13	45	18,5-23,5		200



Security strike plates, Connect

Security strike plates 1489-11/1489-12

Application

For perimeter protection and other important doors, where security is of the essence.

Features

- Complies with EN 12209 security grade 5
- Mounted with high security screws to resist higher break force and for maximum resistance to attack.

Function

- For protection of the lock case deadbolt from physical attack and manipulation.
- With edge-rolled front for low friction between strike plate and the latch.
- Easily adjustable in steps of 1,5 mm



1489-11



1489-12

Model	Width, (mm)	Lip, (mm)	Angle	Length, (mm)
1489-11	40	12-18		200
1489-12	45	17-23		200

Standard strike plates, Connect

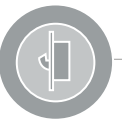

Standard strike plates 1264-1 – 1264-8

Application

For interior doors and residential premises where standard locking is required.

Features

- For limited break force
- Rounded leading edge for low friction between the strike plate and latch bolt

Function

- Keep the door in closed position through the latch bolt/deadbolt engagement
- 1264-1 – 1264-7 with single adjusting lip for adjustment of border pressure



1264-1



1264-5

Model	Width, (mm)	Lip, (mm)	Angle	Length, (mm)
1264-1	36	13.5		150
1264-2	36	16		150
1264-3	36	19		150
1264-4	40	23		150
1264-5	36	13		150
1264-6	36	16		150
1264-7	40	20		150
1264-8	24	5.5	22	155



Security strike plates 1887 and 1888

Application

For perimeter protection and other important doors, where security is essential.

Features

- Complies with EN 12209 security grade 5
- Mounted with high security screws to resist higher break force and for maximum resistance to attack

Function

- With edge rolled front for low friction between the strike plate and the latch
Ex. 1887-1 – 1887-4 have adjustable lips in the security box to achieve the right border pressure
- Plane security strike plates 1887-1 1887-5 for modular locks have adjustable screws to eliminate elasticity in the frame
- Plane security strike plates 1887-1 1887-4 can be supplemented with a tin plate 1895 for alternative lip width
- 1887-1 – 1887-4 can be complemented with a deadlocking bar 1893 for locks with a deadlocking latch



Model	Width, (mm)	Lip, (mm)	Angle	Length, (mm)
1824-1	32	5.5	8	225
1824-2	32	5.5	25	225
1824-3	32	7.5	27	225
1824-4	32	7.5	15	225
1824-5	40	14	8	225
1824-6	32	5.5	15	225
1824-7	32	5.5	20	225
1887-1	40	12.5		200
1887-2	40	15.5		200
1887-3	43.5	19		200
1887-4	45	20.5		200
1887-5	29.5	4.5	29.5	200
1888-1	30	7		150
1888-5	29	6	27	150
1887-9	25	5.5		245

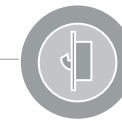

Security strike plates 1889-11/1889-12

Application

For perimeter protection and other important doors, where security is of the essence.

Features

- Complies with EN 12209 security grade 5.
- Mounted with high security screws to resist higher break force and for maximum resistance to attack.

Function

- For protection of the lock case deadbolt from physical attack and manipulation.
- With edge-rolled front for low friction between strike plate and the latch.
- Easily adjustable in steps of 1,5 mm.



Model	Width, (mm)	Lip, (mm)	Angle	Length, (mm)
1889-11	40	12-18		200
1889-12	45	17-23		200



Strike plate

2800, 2860, 2861, 2862, 2863, 2864, 2865, 2866, 2876, 2885, 2887, 2888, 2892

Application

For interior doors and residential premises where standard locking is required.

Features

- For limited break force
- Rounded leading edge for low friction between the strike plate and latch bolt

Function

- Keep the door in a closed position throughout the latch/deadbolt engagement
- 2864, 2865, 2860 and 2861 with single adjusting lip for adjustment of border pressure



Model	Width, (mm)	Lip, (mm)	Angle	Length, (mm)	Right/Left
2860-1	35	15.5	-	155	X
2860-2	41.5	22	-	155	X
2860-5	24	3.5	22	155	X
2861	40	21	-	135	
2862-1	35	15	-	125	
2862-2	35	21.5	-	125	
2862-3	32.5	14.5	-	213	
2862-6				125	
2863-5	22	4	8	215	
2863-6	22	4	22	215	
2864-1	35	15	-	125	
2864-2	32.5	12.5	-	125	
2865-1	40	12.5	-	200	
2865-2	40	15.5	-	200	
2885	36	17.5	-	83	
2887-1	25	-	-	125	
2887-2	40	-	-	132	
2888	22	-	-	83	



Strike plate

2866-1, 2866-2, 2876-1, 2876-5, 2892-5, 2892-6

Application

For interior doors and residential premises that do not require approved locking.

Features

- For limited break force
- Rounded leading edge for low friction between the strike plate and latch bolt

Function

- Keep the door in a closed position with latch or deadbolt operation



2866-1



2866-2



2876-1*



2876-5*



2892-5



2892-6

Model	Width, (mm)	Lip, (mm)	Angle	Length, (mm)	Right/Left
2866-1	33	14.5	-	127	X
2866-2	43	14.5	-	127	
2876-1*	60	9	-	70	
2876-5*	27.5	6	8	111	
2892-5	20	2	12.5	50	
2892-6	17		6	50	

* = For rim lock 576 and 577

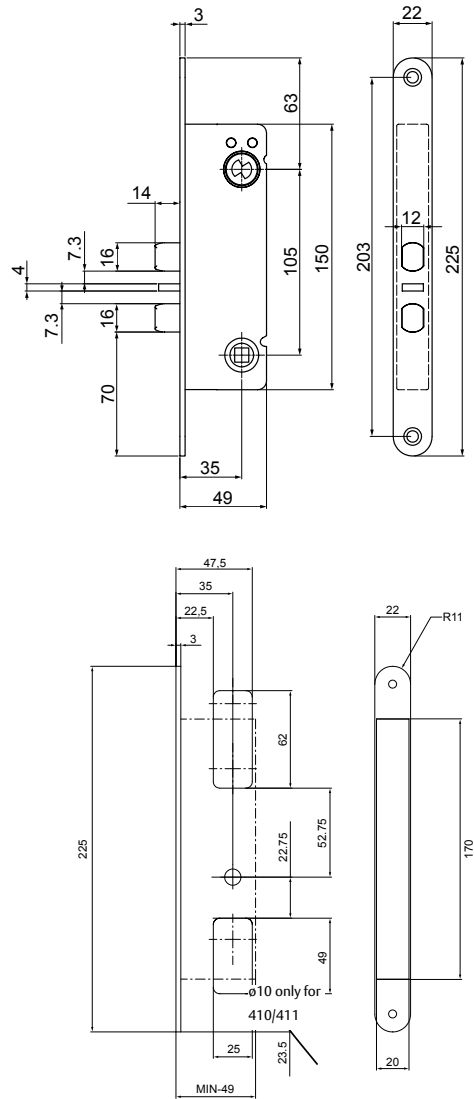

Dimensions in mm, not proportional

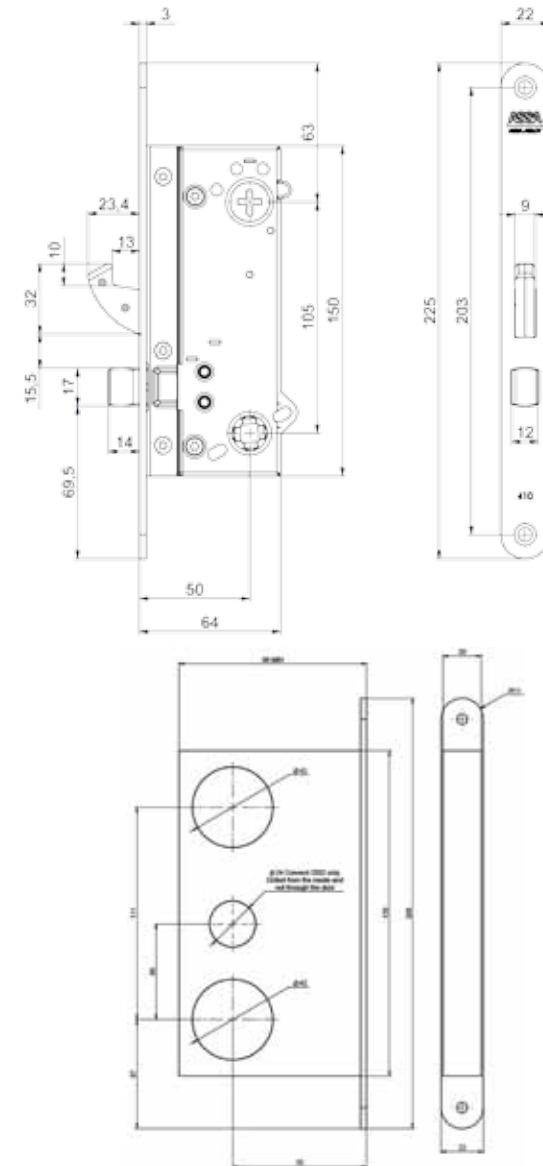

Dimension drawing, Connect 410-70, 410-70 MA

Dimension drawing, Connect 410-70, 410-70 MA

Dimensions in mm, not proportional

Lock cases

Lock cases

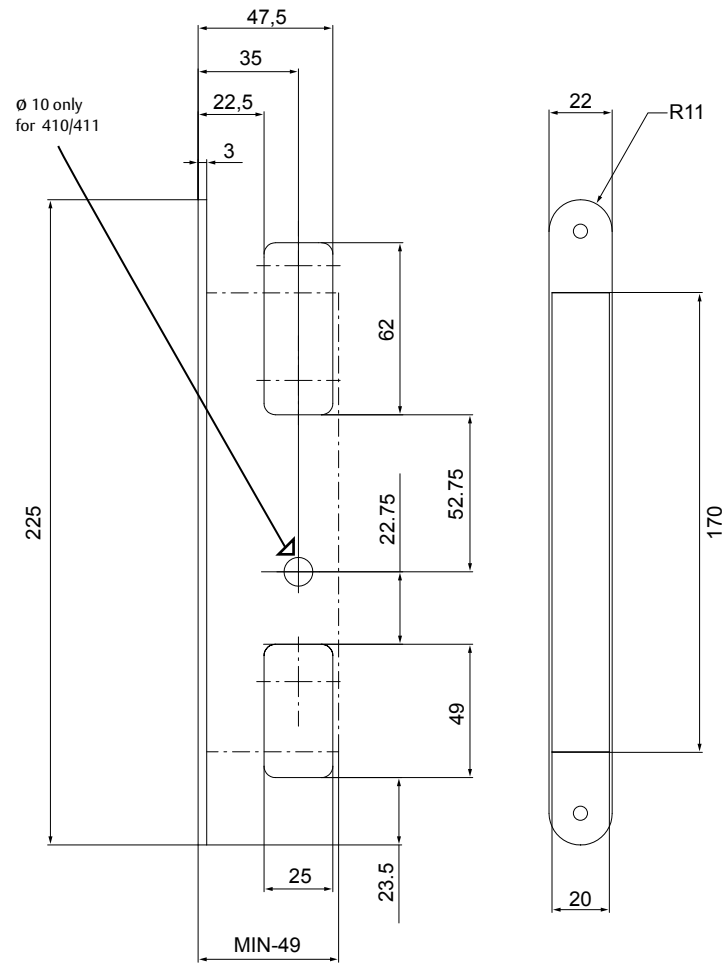

Dimensions in mm, not proportional

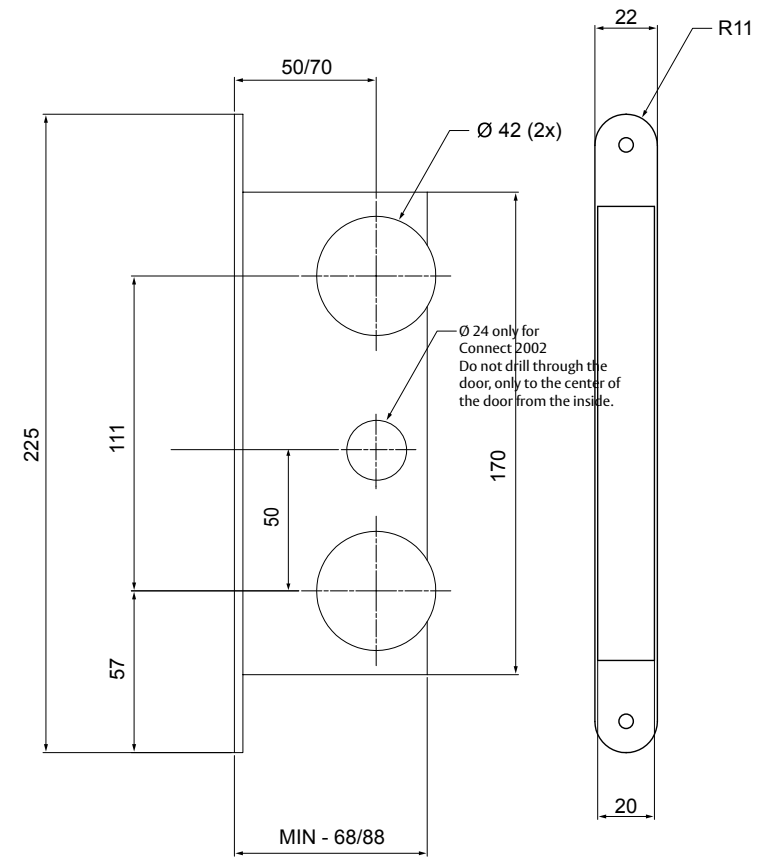

Dimensions in mm, not proportional

Lock cases

Lock cases

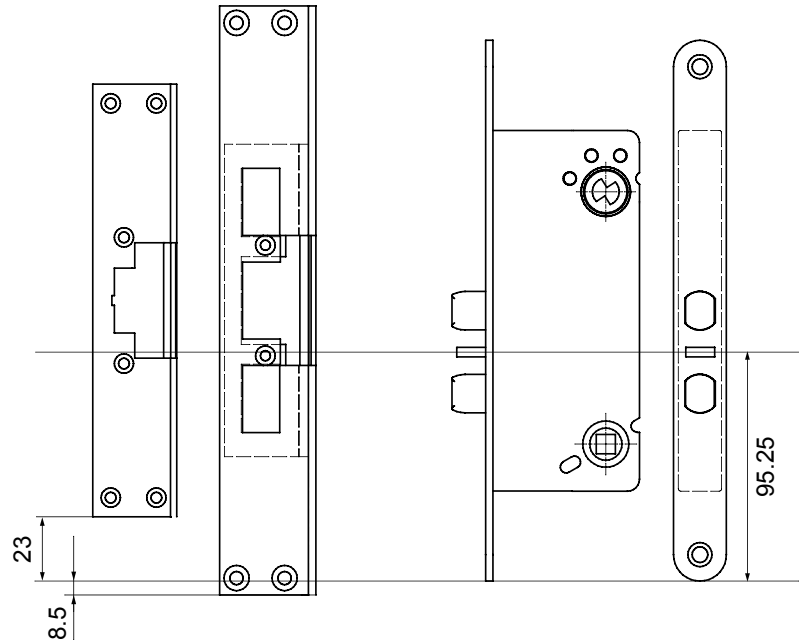

Dimensions in mm,
not proportional

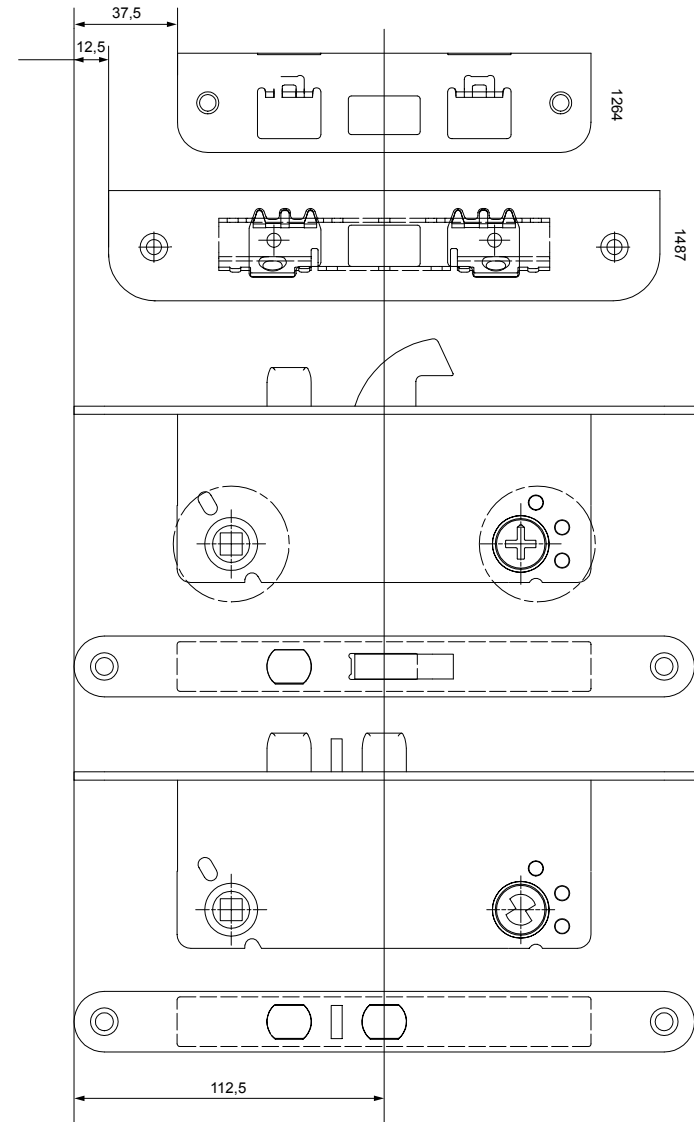

Dimensions in mm,
not proportional

Lock cases

Lock cases



Dimension drawings, modular locks

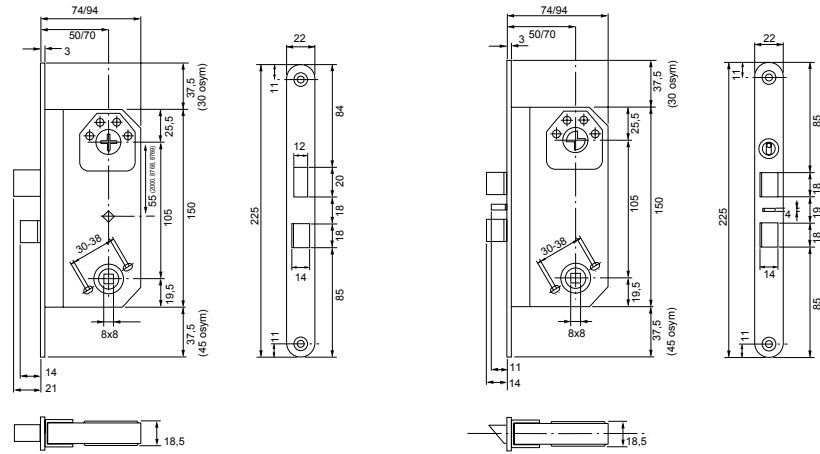

Dimensions in mm
not proportional

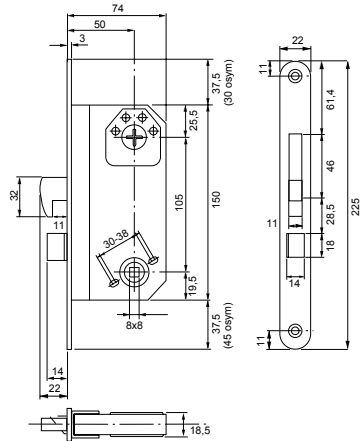

Dimensions in mm
not proportional

Dimension drawings, narrow profile locks

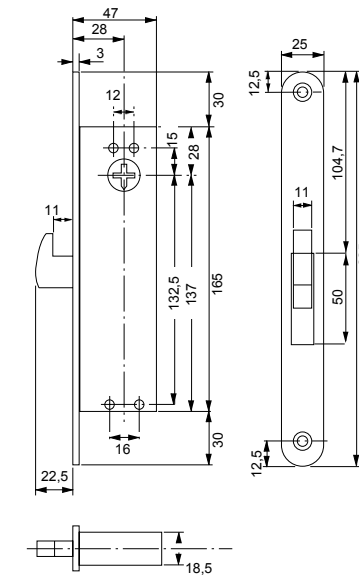
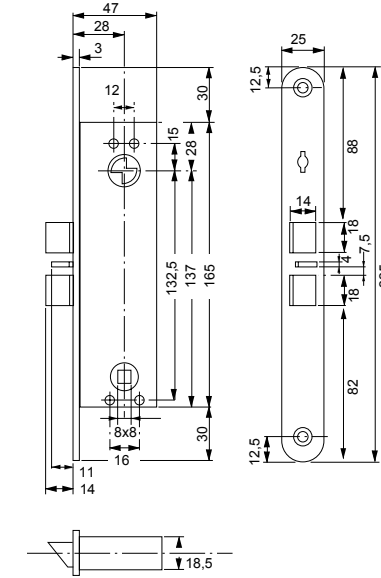
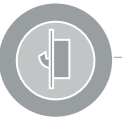

Dimensions in mm,
not proportional



Mortice, modular locks 50/70

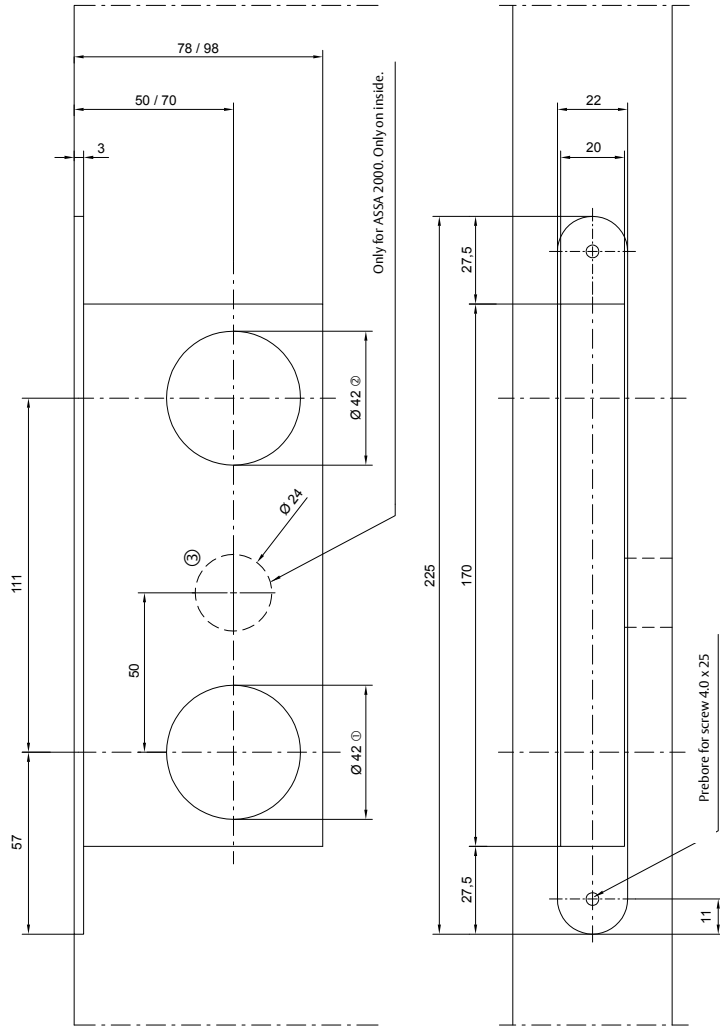

Dimensions in mm, not proportional

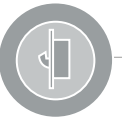

Mortice, narrow profile locks

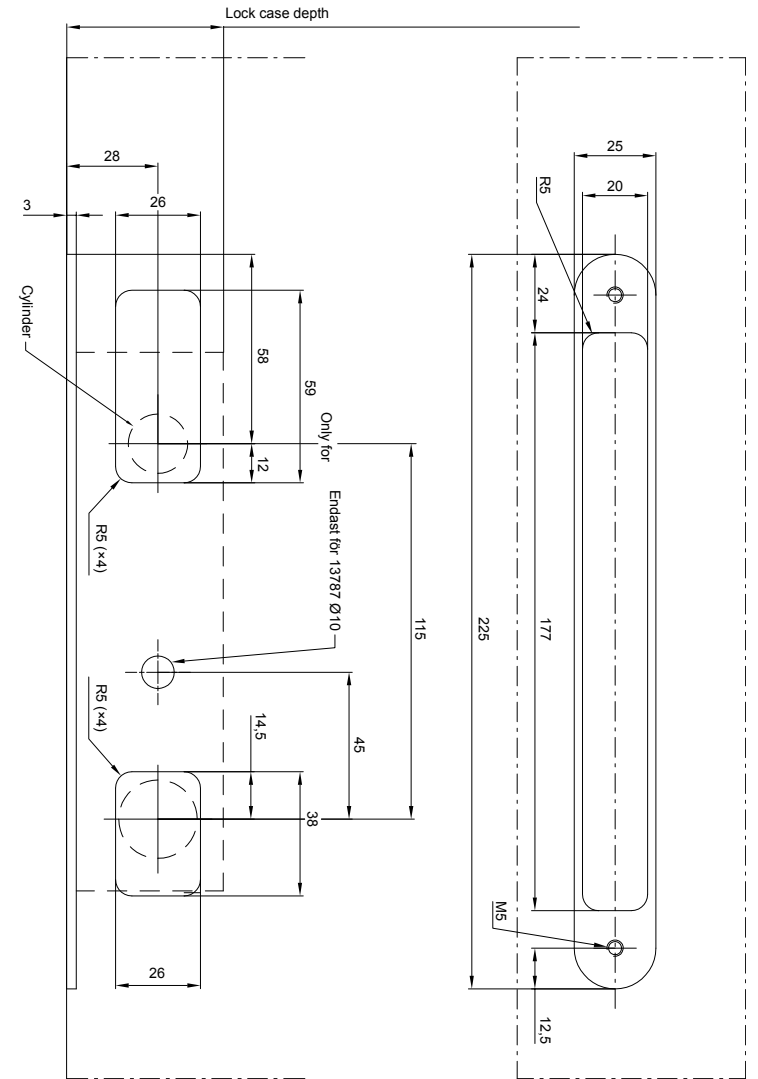

Dimensions in mm, not proportional

Lock cases

Lock cases



Mortice, strike plate 1487

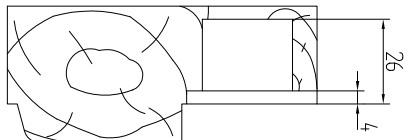
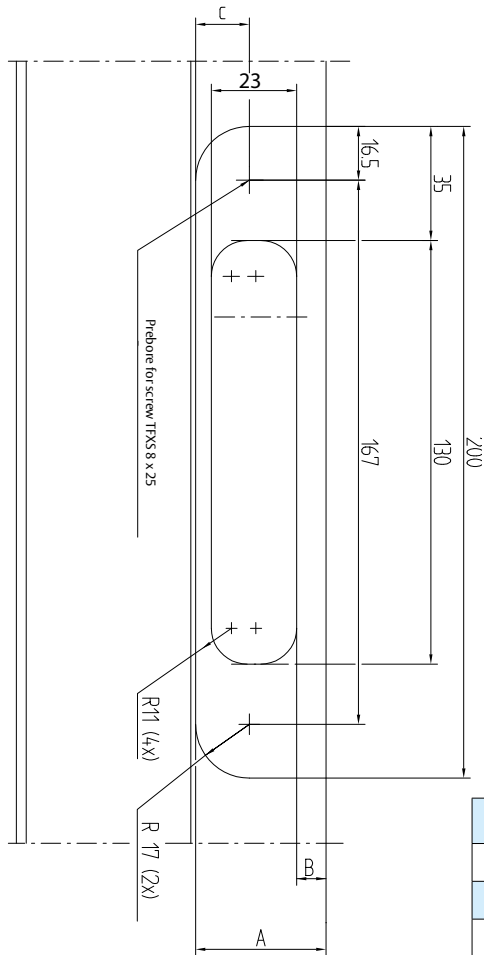

Strike plate	A, (mm)	B, (mm)	C, (mm)
1487-1	40	9.5	19.5
1487-2	40	12.5	16.5
1487-3	43.5	15.5	16.5
1487-4	45	17.5	16.5
1487-11	40		
1487-12	43.5		
1487-13	45		

Dimensions in mm, not proportional



Mortice, strike plate 1887

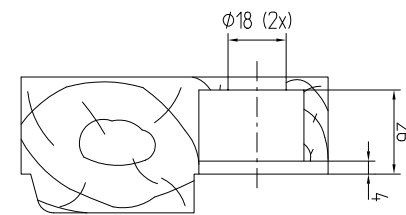
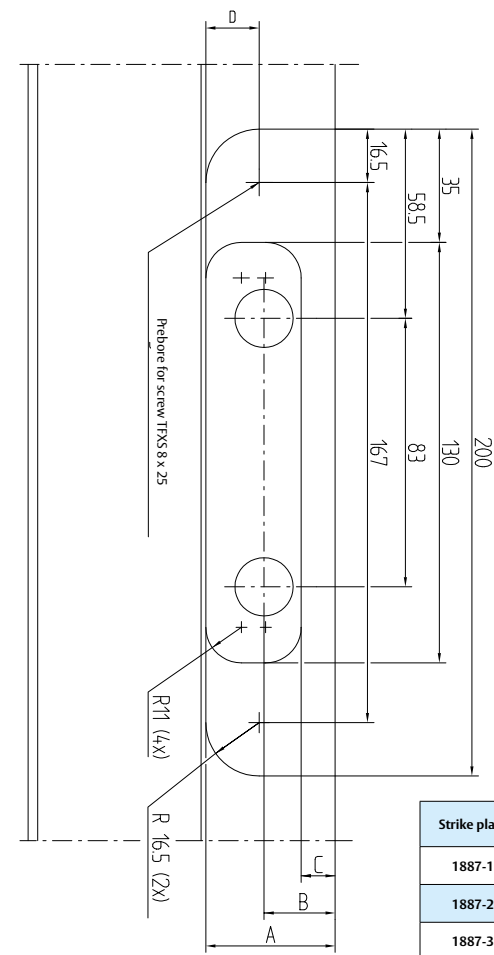

Strike plate	A, (mm)	B, (mm)	C, (mm)	D, (mm)
1887-1	40	19	7.5	19.5
1887-2	40	22	10.5	16.5
1887-3	43.5	25.5	14	16.5
1887-4	45	27	15.5	16.5

Dimensions in mm, not proportional

Lock cases

Lock cases



ELECTRO-MECHANICAL LOCKS



Flexible operational solution

Electric locks have a wide range of applications from medium-security internal doors to high-security perimeter doors. Electric locks offer the perfect combination of fast convenient access, safe exit, remote operation and, surveillance and last but not least, high-security.

Any type of electronic access control system, from a simple push button via timer switches and code locks to the most advanced access control or burglar alarm systems, can operate electric locks.

Secure, safe and convenient

The electric lock range stretches from high-security motor locks via convenient single-hand operated solenoid handle locks to cost-efficient electric strikes.





931-17

9487-2

ASSA 900, 910, 911, 920

Application

The ASSA electric strikes in the 900 series are ideal for doors with standard security requirements and are suitable for both perimeter security and interior applications in retail, commercial and industrial premises, as well as in entrances and common areas in apartment buildings.

Features

Designed for use in doors in combination with single or double action locks.

Function

ASSA Electric Strikes in the 900 series are available in 4 main types:

- Multifunction 900, 900M
 - 12-24V AC/DC
 - Easily selectable locked/unlocked function
- Locked function/fail secure 910, 910M, 910C
 - 12-24V AC/DC
 - Locked with power failure
- Unlocked function/fail safe 911, 911M, 911C
 - 12-24V AC/DC
 - Unlocked with power failure
- Fire-rated/fail secure 920, 920M, 920C
 - 12-24V AC/DC
 - Locked with power failure

ASSA 900 Multi

- Selectable locked/unlocked function
- Holding force 6.5 kN
- Lock case in zinc alloy
- Pivoting latch in steel
- Monitor contact (900M)

ASSA 910 fail secure (locked)

- Holding force 8 kN
- High impact and shockproof
- Lock case in zinc alloy
- Pivoting latch in steel
- Opens with normal pre load
- Monitor contact (910M), Hi-O (910C)

ASSA 911 fail safe (unlocked)

- Holding force 8 kN
- High impact and shockproof
- Lock case in zinc alloy
- Pivoting latch in steel
- Opens with normal pre load
- Monitor contact (911M), Hi-O (911C)

ASSA 920 Fire rated E/El 60 Fail secure

- Holding force 10 kN
- High impact and shockproof
- Lock case in steel
- Pivoting latch in steel
- Opens with normal pre load
- Lock contact (920M), Hi-O (920C)

Technical data

- ASSA electric strikes in 900-series feature:
- Built-in transient protection
 - Power supply 12-24VAC/VDC +/- 10%
 - Starting current at 24V 250mA operation 80mA
 - Starting current at 12V 500mA operation 160mA

Accessories

Accessories for the ASSA electric strikes in the 900-series include several faceplates intended for different door environments in wood/steel and aluminum.



Mounting poles

Steel frames

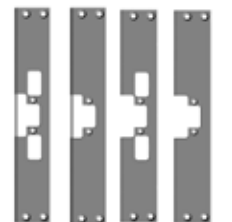

930 932 931-17 933-17
931-20 933-20
931-26 933-26

Wooden frames



930T 932T 9487-2
9487-3
9487-4

Sapa aluminium

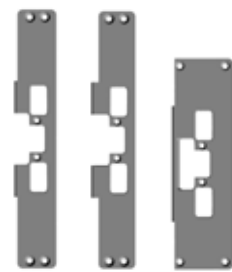

940 942 9487-10

Schuco aluminium

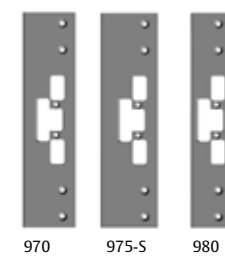

970 975-S 980

Wicona aluminium

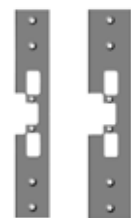

965-W 975-W

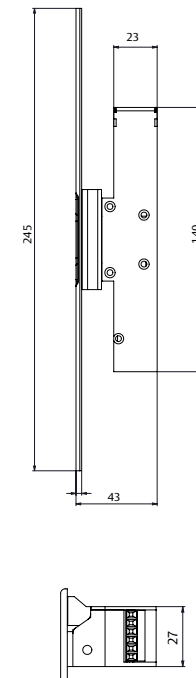

Height ratio for C-C offset different types of locks

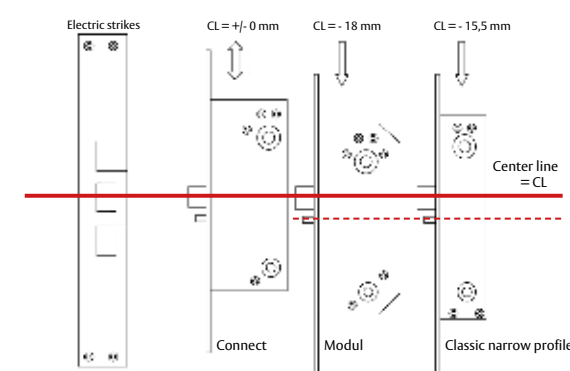



ASSA 131, 5131, 8131, 331, 5331, 8331

Application

ASSA high-security electric strikes provide extreme strength and durability, ideal for high-security and frequently used applications.

Suitable for security applications such as perimeter doors, entrance doors, gates and other applications in industry, office and trading premises.

ASSA high-security electric strikes with fail-locked operation are rated E/I60 for use in fire protective doors.

ASSA high-security electric strikes with fail-unlocked escape-safe operation guarantee operation even at a pre load of up to 5kN (500 kg), making them excellent in escape route applications and in air locks.

Function

ASSA high-security electric strikes provide two main options

- Fail secure operation (131, 5131, 8131)
 - Locked if power failure occurs
- Fail safe escape-safe operation (331, 5331, 8331)
 - Unlocked escape safe if power failure occurs

Features

- Very sturdy, can be locked and unlocked more than 1,000,000 times
- Pivoting latch and housing made of steel
- Operates in conjunction with dead-latched single latch locks

Fail-locked operation (131, 5131, 8131)

- Rated E/I60 for use in fire protective doors
- Will operate even at a pre load of up to 250N (25 kg)
- Extreme holding force 15 kN (1,500 kg)
- Extremely impact proof and shock proof
- Optional monitor contacts
 - Latch bolt engagement monitoring (5131)
 - Keeper deadlocking and latch bolt engagement monitoring (8131)

Fail-unlocked operation (331, 5331, 8331)

- Guaranteed operation even at a pre load of up to 5 kN (500 kg)
- Holding force 7.5 kN (750 kg)
- Required opening force when unlocked 40 N (4 kg)
- Optional monitor contacts
 - Latch bolt engagement monitoring (5331)
 - Keeper deadlocking and latch bolt engagement monitoring (8331)



Technical specification

ASSA electric strikes rated DC only. A protective diode (e.g. 1N4004) should be connected as close to the coil as possible. This is necessary to protect superior system from transients (peaks).

- Current / Voltage, fail-locked (131, 5131, 8131)
 - 300 mA @ 12 VDC ± 10 %
 - 160 mA @ 24 VDC ± 10 %
- Current / Voltage, fail-unlocked (331, 5331, 8331)
 - 490 mA @ 12 VDC ± 10 %
 - 230 mA @ 24 VDC ± 10 %
- Microswitches changeover NO/NC
 - Rated 1 A @ 30 VDC

Typical installation

To maintain characteristics of an ASSA electric strike, the strike should be fitted with a 3 mm ± 1mm gap between the faceplate of the strike and the front end of the lock case.

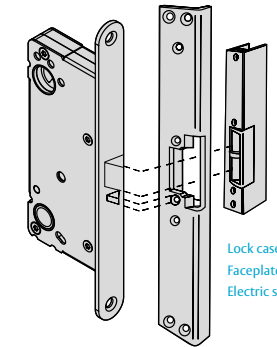

Lock case Connect 232-50
Faceplate 830
Electric strike 5131

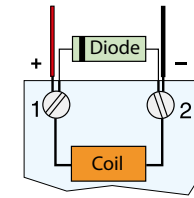

A protective diode should be connected; the stripe on the diode should be wired to + (all)

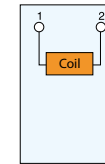

Electric strike (131, 331)

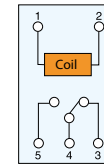

Electric strike with latch bolt monitoring contact (5131, 5331)

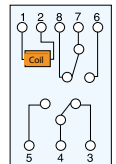

Electric strike with latch bolt and keeper monitoring contact (8131, 8331)

Accessories

A variety of Faceplates suited to ASSA high-security electric strikes is provided. Your choice of faceplate should be based on the materials and measurements of the door and frame as well as on the type of application required.

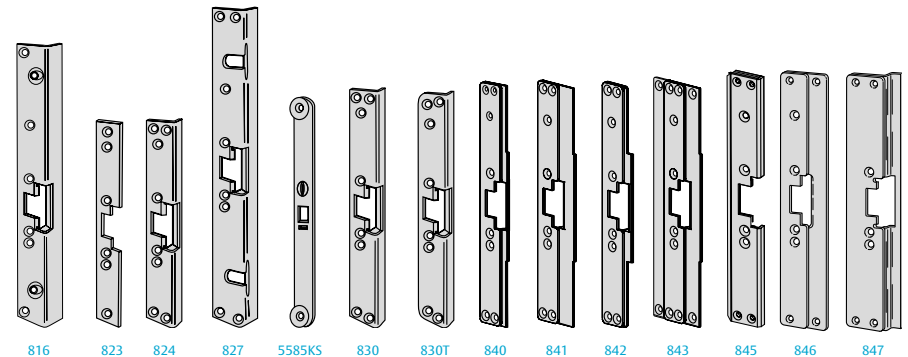

816 823 824 827 5585KS 830 830T 840 841 842 843 845 846 847



ASSA 816, 823, 824, 830, 830T

Application

ASSA faceplates for high-security electric strikes adapt the fitting and characteristics to the present application.

Function

Selection of a suitable electric strike and faceplate is determined by several factors. Consider security and fire protection as well as presence or an option of an automatic door opener. Door and frame design are crucial i.e. modular, i.e. with a or narrow style profile. Material is also an issue, e.g. wood, aluminium or steel. To select the right product you also have to know which type of mechanical lock that is provided to operate in conjunction with the electric strike, and the measurement from the door surface (on the hinge side) to the flat side of the latch (lip width).

Features

ASSA high-security electric strikes with fail-locked operation in conjunction with cylinder latch locks (without a back-lock feature) are approved according to European standards for use in fire protective doors grade EI/E60.

If you have any questions regarding lock/strike combination in a fire protective door, please contact ASSA or your local ASSA dealer.



Technical specifications

ASSA 816

- Wood frames
- Dead-latched cylinder latch locks
- Lip width 15 mm

ASSA 823

- Steel or wood frames
- Dead-latched cylinder latch locks
- Lip width 4 mm

ASSA 824

- Steel or wood frames
- Dead-latched cylinder latch locks
- Lip width 15 mm

ASSA 830, 830T*

- Steel or wood frames
- Dead-latched cylinder latch locks
- Lip width 15 mm

* T indicates faceplates with rounded corners

ASSA 840, 841, 842, 843, 845, 846, 847

- ASSA supplies a wide range of tailor-made faceplates for SAPA, Schüco and Wicona. For aluminium profile systems, see separate pages.

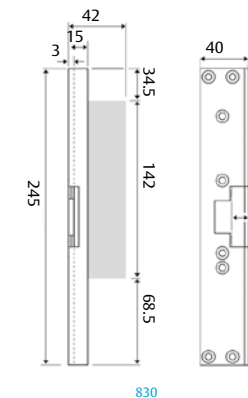
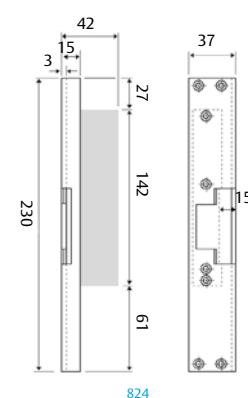
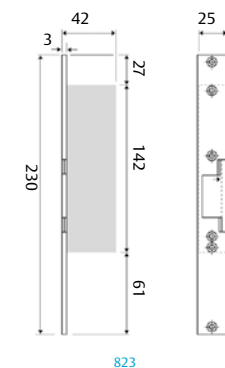
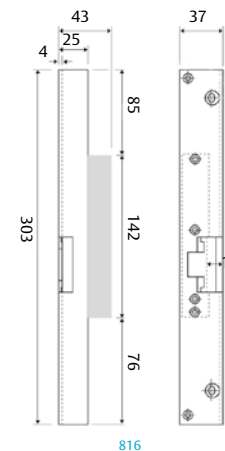

Dimensions in mm, not proportional

Electromechanical locks

Electromechanical locks



ASSA 585

Application

ASSA 585 standard-security electric strikes provide high strength and durability, ideal for frequently used applications. Suitable for perimeter doors, entrance doors, gates and other frequently used applications in industry, office and trading premises.

Function

ASSA 585 standard-security electric strikes provide three main options

- Universal operation
- Fail-locked/unlocked operation easily selectable on site
- 12-24 VDC

Features

- Durable, can be locked and unlocked more than 500,000 times
- Suited to fire protective doors in conjunction with a double latch lock and designated faceplate
- Keeper made of bronze and housing of zinc alloy
- Operates in conjunction with dead-latched single or double latch locks

Universal operation

- Provides fail-locked/unlocked operation, selectable on site
- Multi voltage 12 – 24 VDC
- Holding force 7 kN (700 kg)
- Impact proof and shock proof
- Monitor contact
- Latch bolt engagement monitoring
- ASSA universal operation provides built-in transient (peak) protection
- Current voltage, 340 mA – 185 mA @ 12 – 24 VAC/VDC ± 10 %

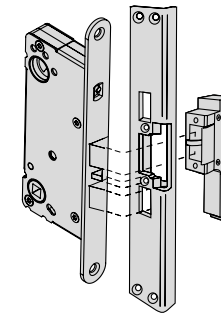

Lock case Connect 221-50
Faceplate 730
Electric strike 585

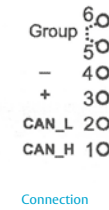

Universal operation

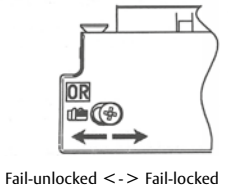

Typical installation

To maintain characteristics of a ASSA electric strike, the strike should be fitted with a 3 mm ± 1 mm gap between the faceplate of the strike and the front end of the lock case.

Accessories

A variety of faceplates suited to ASSA standard-security electric strikes is provided. Your choice of faceplate should be based on the materials and measurements of the door and frame as well as on the type of application required

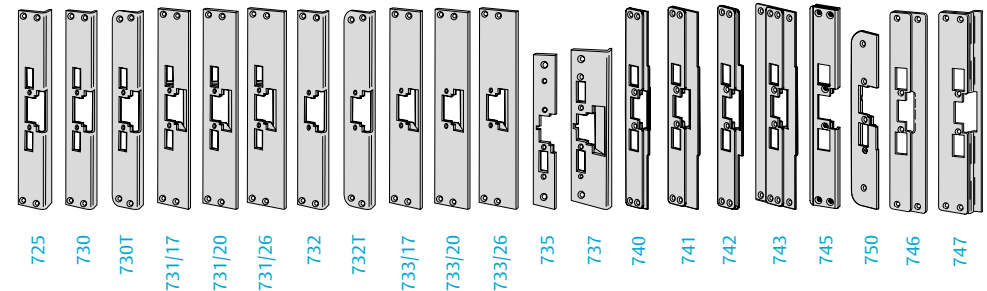



ASSA 75, 575, 70, 570, 71, 571

Application

ASSA standard-security electric strikes provide high strength and durability, ideal for frequently used applications. Suitable for perimeter doors, entrance doors, gates and other frequently used applications in industry, office and trading premises.

Function

ASSA standard-security electric strikes provides three main options

- Universal operation (75, 575)
 - Fail-locked/unlocked operation easily selectable on site
 - 12-24 VAC/VDC
- Fail-locked operation (70, 570)
 - Locked if power failure occurs
- Fail-unlocked operation (71, 571)
 - Unlocked if power failure occurs

Features

- Durable, can be locked and unlocked more than 500,000 times
- Suited to fire protective doors in conjunction with double latch lock and designated faceplate
- Keeper made of bronze and housing of zinc alloy
- Operates in conjunction with dead-latched single or double latch locks

Universal operation (75, 575)

- Provides fail-locked/unlocked operation, selectable on site

- Multi voltage 12 – 24 VAC/VDC
- Holding force 7 kN (700 kg)
- Impact and shock proof
- Optional monitor contact
 - Latch bolt engagement monitoring (575)

Fail-locked operation (70, 570)

- Holding force 7 kN (700 kg)
- Impact proof and shock proof
- Optional monitor contact
 - Latch bolt engagement monitoring (570)

Fail-unlocked operation (71, 571)

- Holding force 7 kN (700 kg)
- Impact proof and shock proof
- Optional monitor contact
 - Latch bolt engagement monitoring (571)

Technical specifications, Universal (75, 575)

ASSA universal operation provides built-in transient (peak) protection

- Current voltage, 340 mA–185 mA @ 12 – 24 VAC/VDC ± 10 %

Technical specifications, (70, 570, 71, 571)

ASSA electric strikes rated DC only. A protective diode (e.g. 1N4003) should be connected as close to the coil as possible. This is necessary to protect superior system from transients (peaks).

- Current voltage (70, 71, 570, 571)
 - 230 mA @ 12 VDC ± 10 %
 - 140 mA @ 24 VDC ± 10 %
- Microswitches changeover NO/NC
 - Rated 1 A @ 30 VDC



Typical installation

To maintain characteristics of a ASSA electric strike, the strike should be fitted with a 3 mm ± 1 mm gap between the faceplate of the strike and the front end of the lock case.

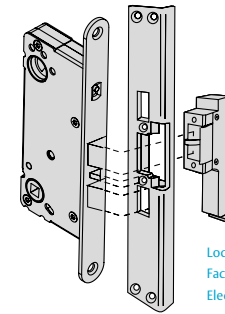

Lock case Connect 221-50
Faceplate 730
Electric strike 575

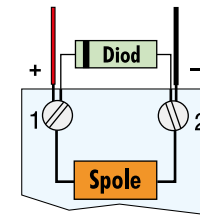

A protective diode should be connected; the stripe on the diode should be wired to + (NOT valid for Universal 75, 575)

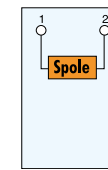

Electric strike (75, 70, 71)

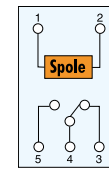

Electric strike with latch bolt monitor contact (575, 570, 571)

Accessories

A variety of faceplates suited to ASSA standard-security electric strikes is provided. Your choice of faceplate should be based on the materials and measurements of the door and frame as well as on the type of application required.

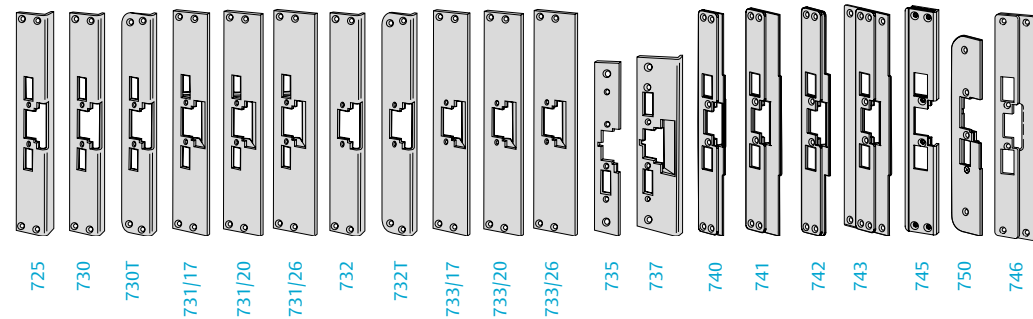



Faceplates

Application

ASSA faceplates for standard-security electric strikes adapt fitting and characteristics to the present application.

Function

Selection of a suitable electric strike and faceplate is determined by several factors. Consider security and fire protection as well as presence or the option of an automatic door opener. Door and frame design are crucial, i.e. modular or narrow style profile.

Material is also an issue, e.g. wood, aluminium or steel. To select the right product you also have to know which type of mechanical lock that is provided to operate in conjunction with the electric strike, and the measurement from the door surface (on the hinge side) to the flat side of the latch (lip width).

Features

Use in fire protective doors ASSA standard-security electric strikes in conjunction with double latch locks are approved according to European standards for use in fire protective doors grade EI/E60.

If you have any questions regarding lock/strike combination in a fire protective door, contact ASSA or your local ASSA dealer.

Technical specifications

ASSA 725

- Wood, steel or aluminium frame
- Dead-latched double latch locks
- Lip width 15 mm

ASSA 730, 730T*

- Wood, steel or aluminium frame
- Dead-latched double latch locks
- Lip width 15 mm

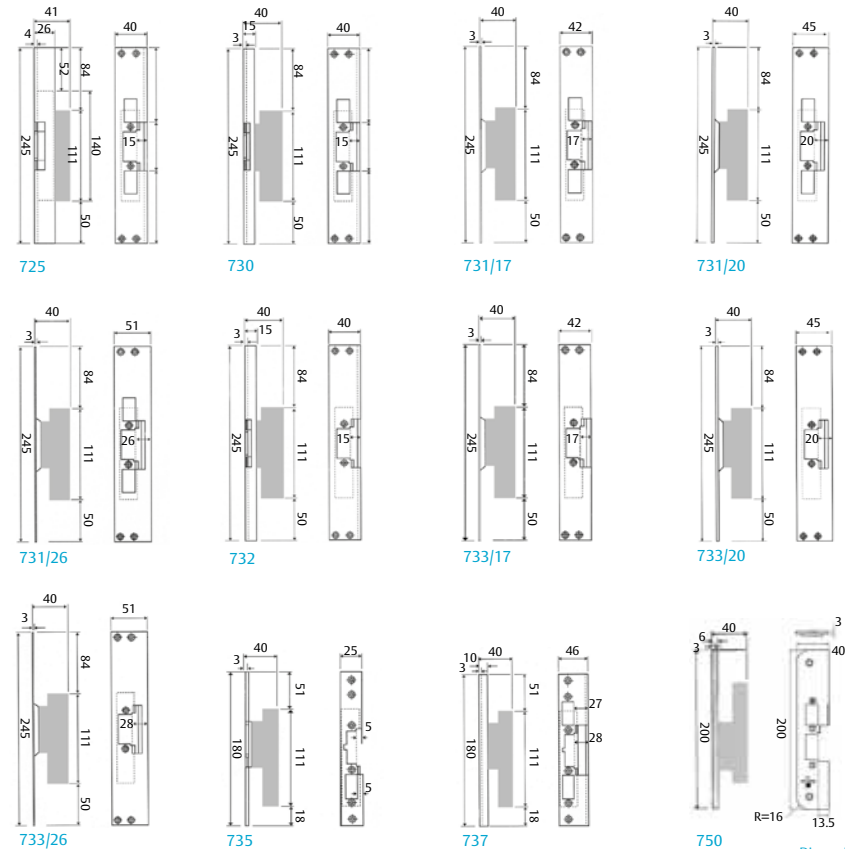

Dimensions in mm, not proportional

ASSA 731/17, 731/20, 731/26

- Wood, steel or aluminium frame
- Dead-latched double latch locks
- Lip width 17/20/26 mm

ASSA 732, 732T*

- Wood, steel or aluminium frame
- Dead-latched cylinder latch locks
- Lip width 15 mm

ASSA 733/17, 733/20, 733/26

- Wood, steel or aluminium frame
- Dead-latched cylinder latch locks
- Lip width 17/20/26 mm

ASSA 735

- Aluminium frame
- Dead-latched double latch locks
- Lip width 5 mm

ASSA 737

- Aluminium frame
- Dead-latched double latch locks
- Lip width 27 mm

ASSA 750

- Steel frame
- Dead-latched double latch locks
- Lip width 10.5 mm

ASSA 740, 741, 742, 743, 745, 746, 747

- ASSA supplies a wide range of tailor-made faceplates for SAPA, Schüco and Wicona. For aluminium profile systems, see separate pages.

* T indicates faceplates with rounded corners.



ASSA 14, 514, 114, 5114

Application

ASSA medium-security electric strikes provide medium strength and durability; suitable for medium-security applications such as internal doors in industry, office and trading premises

Function

ASSA medium-security electric strikes provide two main options

- Fail-locked operation (14, 514)
 - Locked if power failure occurs
- Fail-unlocked operation (114, 5114)
 - Unlocked if power failure occurs

Features

- Keeper made of steel and housing of zinc alloy
- NEVER use ASSA medium-security electric strikes in fire protective doors
- Operates in conjunction with dead-latched single or double latch locks

Fail-locked operation (14, 514)

- Holding force 4 kN (400 kg)
- Optional monitor contact
 - Latch bolt engagement monitoring (514)

Fail-unlocked operation (114, 5114)

- Holding force 4 kN (400 kg)
- Optional monitor contact
 - Latch bolt engagement monitoring (5114)

Technical specifications

ASSA electric strikes rated DC only. A protective diode (e.g. 1N4004) should be connected as close to the coil as possible. This is necessary to protect superior system from transients (peaks).

- Current/Voltage (14, 114, 514, 5114)
 - 190 mA @ 12 VDC ± 10 %
 - 110 mA @ 24 VDC ± 10 %
- Microswitches changeover NO/NC
 - Rated 1 A @ 30 VDC



Typical installation

To maintain the characteristics of a ASSA electric strike, the strike should be fitted with a 3 mm ± 1 mm gap between the faceplate of the strike and the front end of the lock case.

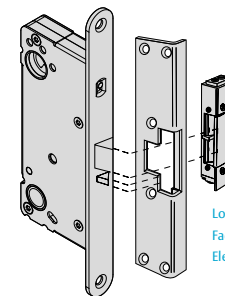

Lock case Connect 231-50
Faceplate 510
Electric strike 514

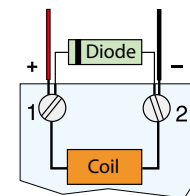

A protective diode should be connected; the stripe on the diode should be wired to +

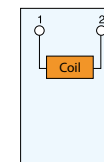

Electric strike (14, 114)

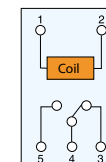

Electric strike with latch bolt monitor contact (514, 5114)

Accessories

A variety of faceplates suited to ASSA electric strikes is provided. Your choice of faceplate should be based on the materials and measurements of the door and frame as well as on the type of application required.

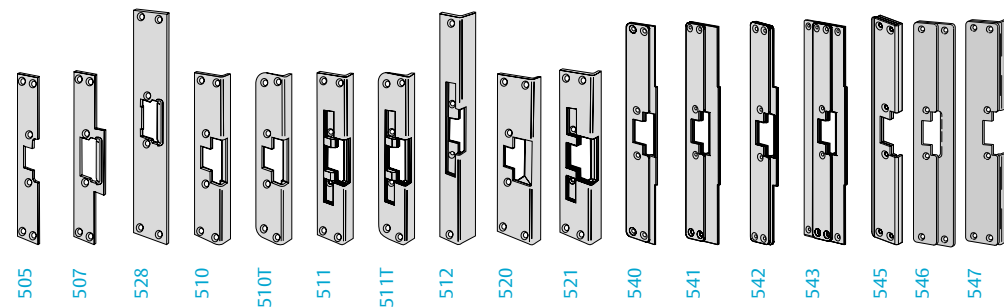



Faceplates for ASSA electric strikes, medium-security



ASSA 505, 507, 510, 510T, 511, 511T, 512, 520, 521, 528

Application

ASSA faceplates for medium-security electric strikes adapt fitting and characteristics to the present application.

Function

Selection of a suitable electric strike and faceplate is determined by several factors. Consider security and fire protection as well as presence or the option of an automatic door opener. Door and frame design are crucial, i.e. modular or narrow style profile.

Material is also an issue, e.g. wood, aluminium or steel. To select the right product you also have to know which type of mechanical lock that is provided to operate in conjunction with the electric strike and the measurement from the door surface (on the hinge side) to the flat side of the latch (lip width).

Features

NEVER use ASSA medium-security electric strikes in fire protective doors.

If you have any questions regarding lock/strike combination in a fire protective door, please contact ASSA or your local ASSA dealer.



Faceplates for ASSA electric strikes, medium-security

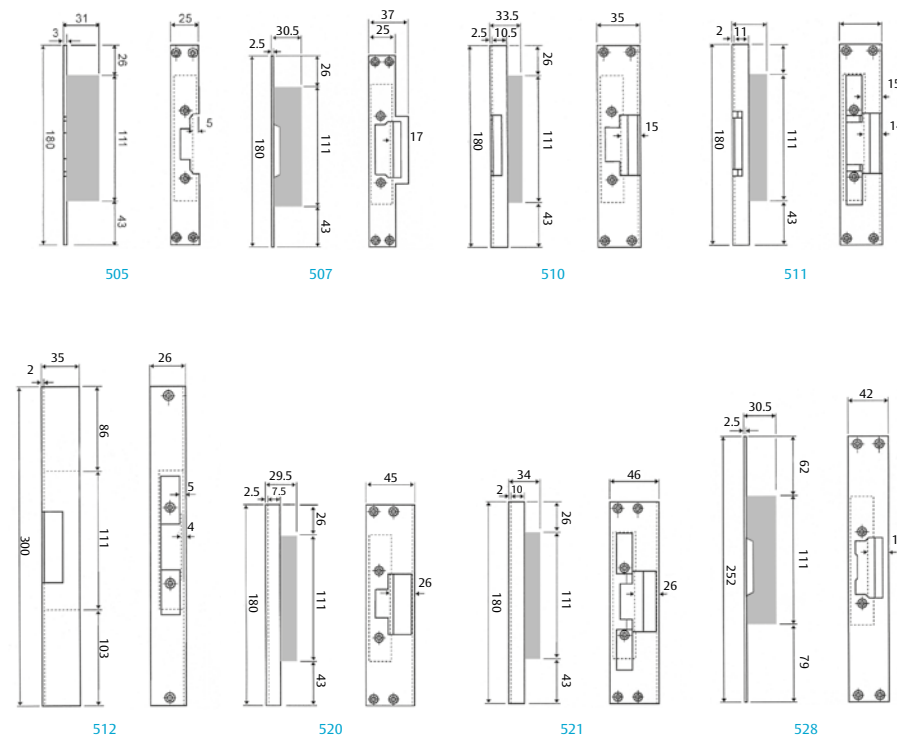

Dimensions in mm, not proportional

Technical specifications

ASSA 505

- Steel or aluminium frame
- Dead-latched double latch locks
- Lip width 5 mm

ASSA 507

- Wood, steel or aluminium frame
- Single latch locks
- Lip width 17 mm

ASSA 510, 510T*

- Wood, steel or aluminium frame
- Dead-latched single latch locks
- Lip width 15 mm

ASSA 511, 511T*

- Wood, steel or aluminium frame
- Dead-latched double latch locks
- Lip width 15 mm

ASSA 512

- Wood frame with thin rebated door
- Dead-latched double latch locks
- Lip width 5 mm

ASSA 520

- Aluminium frame
- Dead-latched single latch locks
- Lip width 26 mm

ASSA 521

- Aluminium frame
- Dead-latched double latch locks
- Lip width 26 mm

ASSA 528

- Wood frame
- Single latch locks
- Lip width 5 mm

*T indicates Faceplates with rounded corners.

ASSA 540, 541, 542, 543, 545, 546, 547

- ASSA supplies a wide range tailor-made faceplates for SAPA, Schüco and Wicona. For aluminium profile systems, see separate pages.



540/541 542 543 740 741 742 743 840/841 842 843

**ASSA 540, 541, 542, 543
ASSA 740, 741, 742, 743
ASSA 840, 841, 842, 843**

Application

ASSA electric strike faceplates are tailor-made for SapaFront aluminium profile systems and adapt fitting and characteristics to an ASSA-SapaFront standard preparation.

Function

Selection of a suitable electric strike and faceplate determined by several factors. Consider security and fire protection as well as presence or the option of an automatic door opener. ASSA offers ASSA electric strikes in three security levels:

ASSA high-security electric strikes

- Holding force 7.5 kN–15 kN (750-1,500 kg)
- Guaranteed with pre load of
- Fire approval certified for fail-locked operated versions
- Operates in conjunction with dead-latched single latch locks

ASSA standard-security electric strikes

- Holding force 7 kN (700 kg)
- Suited to fire protective doors in conjunction with double latch locks
- Operates in conjunction with dead-latched single and double latch locks

ASSA medium security electric strikes

- Medium strength 4 kN (400 kg)
- NEVER use ASSA medium-security electric strikes in fire protective doors
- Operates in conjunction with single latch locks

Features

- ASSA SapaFront faceplates are available for door and frame profiles according to the table below
- In SapaFront frames with an ASSA-SapaFront standard preparation, any electric strike security level can be installed without altering the preparation
- If an ASSA classic narrow profile lock (e.g. 1385) is fitted in a SapaFront installation; the lock must be fitted with 22 mm wide forend

Use in fire protective doors

ASSA high-security electric strikes with fail-locked operation in conjunction with cylinder latch locks (without back-lock feature) or ASSA standard-security electric strikes in conjunction with double latch locks are approved according to European standards for use in fire protective doors grade EI/E60. If you have any questions regarding lock/strike combination in a fire protective door occurs, please contact ASSA or your local ASSA dealer.

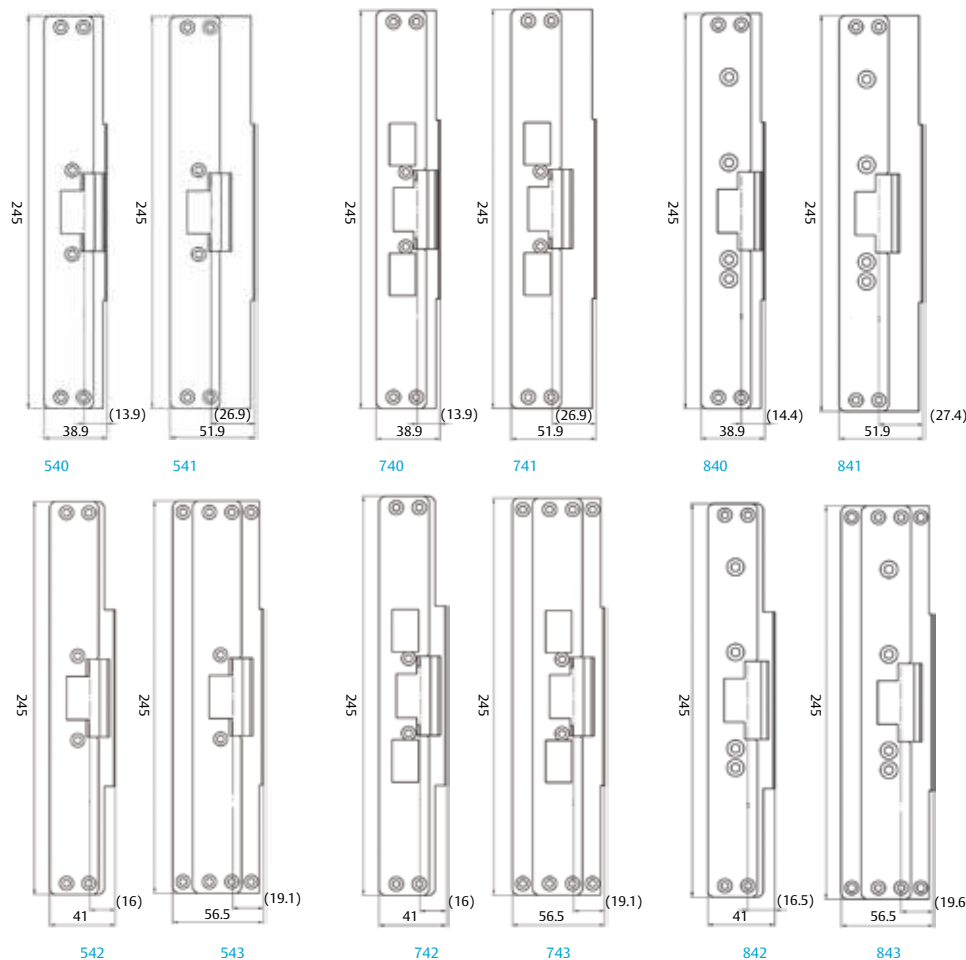

Dimensions in mm, not proportional





Faceplate 545

Faceplate 745

Faceplate 845

Strike plate 545

Faceplate ASSA 545, 745, 845
Strike plate ASSA 545

Application

ASSA electric strike faceplates and strike plate are tailor-made for the Royal S65 and Royal S50N Schüco aluminium profile systems and adapt fitting and characteristics to an ASSA-Schüco standard preparation.

Function

Selection of a suitable electric strike and faceplate is determined by several factors. Consider security and fire protection as well as presence or the option of an automatic door opener. ASSA offers ASSA electric strikes in three security levels:

ASSA high-security electric strikes

- Holding force 7.5 kN–15 kN (750-1,500 kg)
- Guaranteed with pre load of
- Fire approval certified for fail-locked operated versions
- Operates in conjunction with dead-latched single latch locks

ASSA standard-security electric strikes

- Holding force 7 kN (700 kg)
- Suited to fire protective doors in conjunction with double latch locks
- Operates in conjunction with dead-latched single and double latch locks

ASSA medium-security electric strikes

- Holding force 4 kN (400 kg)
- NEVER use ASSA medium-security electric strikes in fire protective doors
- Operates in conjunction with single latch locks

Features

- ASSA Schüco faceplates and strike plate are available for door and frame profiles Royal S65 and Royal S50N
- In Schüco frames with an ASSA-Schüco standard preparation, can any electric strike security level can be installed without altering the preparation
- ASSA strike plate 545 fits the same standard preparation.

Use in fire protective doors

ASSA high-security electric strikes with fail-locked operation in conjunction with cylinder latch locks (without a back-lock feature) or ASSA standard-security electric strikes in conjunction with double latch locks are approved according to European standards for use in fire protective doors grade EI/E60. If you have any questions regarding lock/strike combination in a fire protective door, please contact ASSA or your local ASSA dealer.

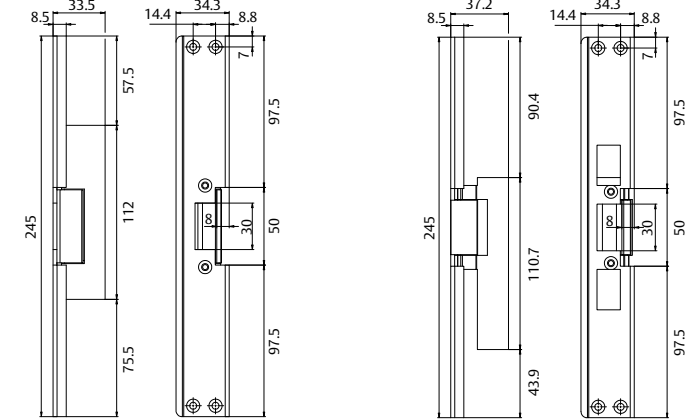

Faceplate 545

Faceplate 745

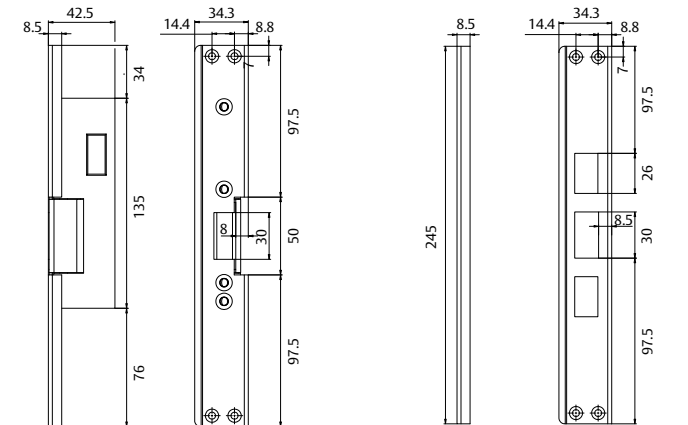

Faceplate 845

Strike plate 545

Dimensions in mm, not proportional



546 746 846 Strike plate 546 547 747 847 Strike plate 547

Faceplates ASSA 546, 746, 846, 547, 747, 847
Strike plates ASSA 546, 547

Application

ASSA electric strike faceplates and strike plate are tailor-made for the Wicona aluminium profile systems Wicstyle 65/65N and adapt fitting and characteristics to an ASSA-Wicona standard preparation.

Function

Selection of a suitable electric strike and faceplate is determined by several factors. Consider security and fire protection as well as presence or the option of an automatic door opener. ASSA offers ASSA electric strikes in three security levels:

ASSA high-security electric strikes

- Holding force 7.5 kN - 15 kN (750–1,500 kg)
- Guaranteed to open with pre load
- Fire approval certified for fail-locked operated versions
- Operates in conjunction with dead-latched single latch locks

ASSA standard-security electric strikes

- Holding force 7 kN (700 kg)
- Suited to fire protective doors in conjunction with double latch locks
- Operates in conjunction with dead-latched single and double latch locks

ASSA medium-security electric strikes

- Holding force 4 kN (400 kg)
- NEVER use ASSA medium-security electric strikes in fire protective doors
- Operates in conjunction with single latch locks

Features

- ASSA Wicona Faceplates and strike plates are available for door and frame profiles Wicstyle 65/65N according to the table below
- In Wicona frames with ASSA-Wicona standard preparations, any electric strike security level can be installed without altering the preparation
- ASSA strike plates 546 and 547 fit the same standard the preparation.

Use in fire protective doors

ASSA high-security electric strikes with fail-locked operation in conjunction with cylinder latch locks (without a back-lock feature) or ASSA standard-security electric strikes in conjunction with double latch locks are approved according to European standards for use in fire protective doors grade EI/E60. If you have any questions regarding lock/strike combination in a fire protective door occurs, contact ASSA or your local ASSA dealer.



	Outswing doors			Inswing doors		
Faceplate	546	746	846	547	747	847
Strike plate	546			547		

Dimensions in mm, not proportional

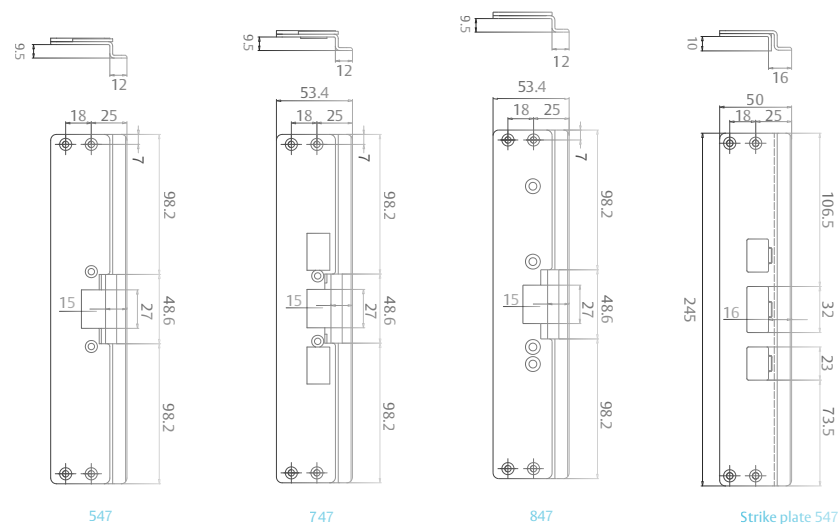
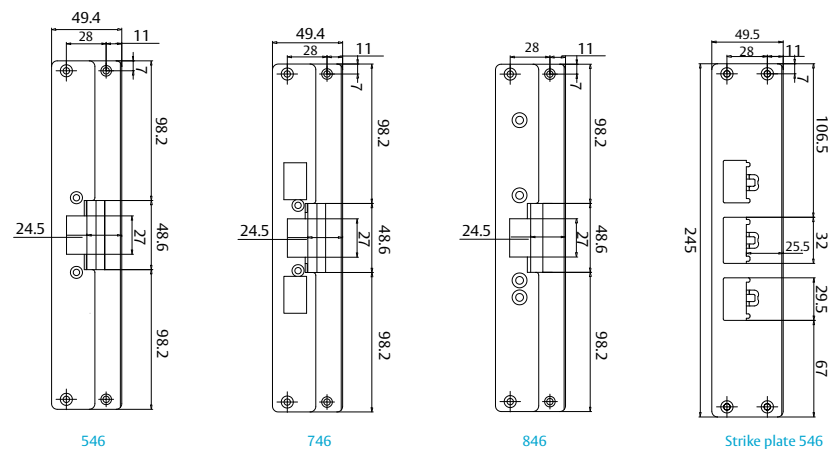



Solenoid Handle Locks



880, 881, 884, 885, 886

Application

ASSA Connect solenoid handle locks are particularly suitable for use in high traffic applications where both reliability and security are major considerations. Suitable for security applications such as perimeter doors, entrance doors, gates and other applications within industry, office and trading premises as well as entrance doors and common areas within residential premises.

ASSA Connect solenoid handle locks are suitable for installation in fire protective doors.

Function

ASSA Connect offers two main types of multi-functional solenoid handle locks.

- Basic (880, 881)
 - Exteriors and interior lever handle followers are electrically controlled.
- Optional mechanical hook bolt (881)
- Split (884, 885, 886)
 - Exterior lever handle split followers is electrically controlled.
 - Interior lever handle split follower retracts latch at all times.
- Optional mechanical hook bolt (885, 886)
- Optional single hand action exit (886)

Features

- Dead latched when door is closed.
- Mechanical override by key or thumbturn.
- Multifunctional
 - 12-24 Volt multivoltage (DC continuously rated).
 - Fail locked/unlocked easy selected on site.
 - Electrically / mechanically controlled side easy selected on site (884, 885).
- 4 monitoring microswitches.
 - Anti thrust bolt (all).
 - Deadbolt thrown (881, 885).
 - Deadbolt withdrawn (881, 885).
 - Inside lever handle (884, 885).
- Additional deadbolt, operated by key or thumbturn (881, 885).
- 50 or 70mm backset option.
- Connectors assembled to all wires to adapt with accompanying connecting cable 81 71 21.

Technical specifications

- Current/Voltage 130mA @ 12VDC +/- 10%
60mA @ 24VDC +/- 15%
- Microswitches Changeover NO/NC, rated 100mA @ 50VDC
- Current/Voltage 130mA @ 12VDC +/- 10%

Accessories

- ASSA Scandinavian cylinders oval or round type
- ASSA bolt through lever handles with built-in return spring
- All ASSA Connect security or standard strike plates
- Connecting cable 81 71 21 (supplied)
- Door loop EA280 / EA281

Solenoid Handle Locks

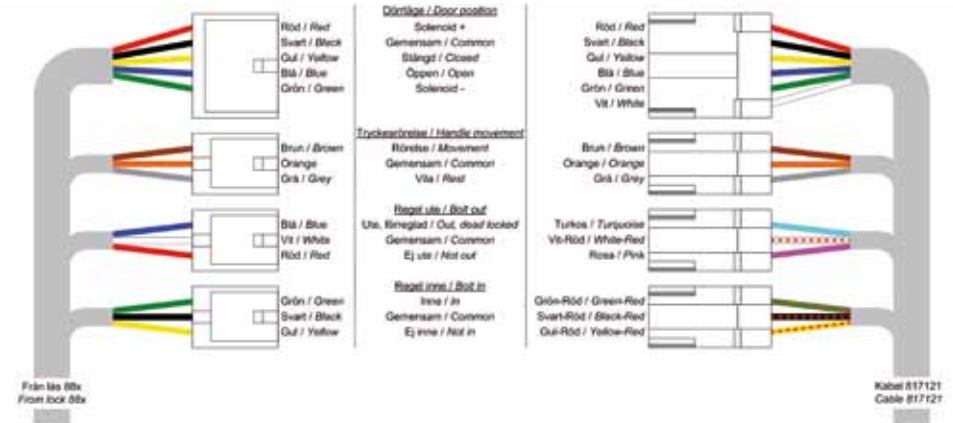
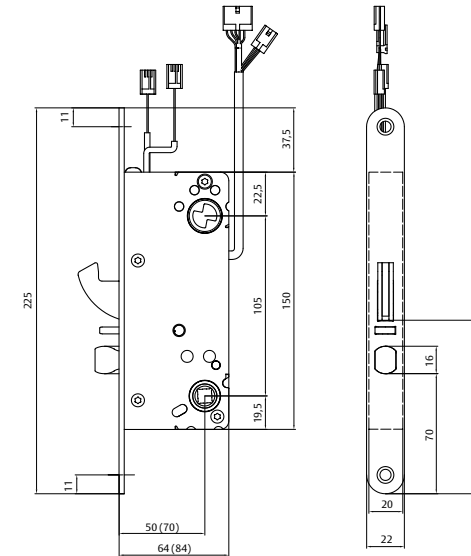

Type	Dead latched	Mech. hook bolt	Split follower	Single hand action exit	Replaces
ASSA Connect 880	X				8030
ASSA Connect 881	X	X			8025
ASSA Connect 884	X		X		8098
ASSA Connect 885	X	X	X		8065
ASSA Connect 886	X	X	X	X	8020



Maintenance, motor lock

Please follow the enclosed documents during installation, do not deviate from these instructions unless you have consulted ASSA and received approval to deviate from them.

Maintenance

- Every six months, apply a small amount of designated grease to latches and bolts. Doors that are used very frequently may need maintenance more often.
- Do NOT use spray lubricants; solvent may seriously harm electronics
- Electric parts need NO maintenance
- ASSA solenoid handle locks provide built-in transient (peak) protection
- To maintain the desired operation and security level of the installed unit, it is of great importance to check and adjust the entire door environment:
 - Lock case and strike plate
 - Lock accessories (lever handle, thumbturn etc.)
 - Hinges, framework and door threshold (sill)
 - Door closer

NBI

The warranty does not apply if the product is:

- Incorrectly assembled
- Opened by unauthorised personnel (broken seal)
- Fitted with accessories or parts not supplied by ASSA

If any uncertainty regarding installation, maintenance or warranty, please contact ASSA AB or your local supplier.



810C-50

811C-50



Hi-O TECHNOLOGY™

810C-50, 811C-50

Application

ASSA Connect 810C/811C-50(70) are motorized hook bolt locks. Motor locks are suitable in high-security applications in industry, office and trading premises.

A hook bolt lock is well suited to all types of doors including double and sliding doors.

In frequently used applications a complementary daytime lock, an ASSA Connect 884-50 solenoid handle lock, is recommended.

Function

The built-in motor operates the hook bolt.

ASSA Connect motor locks are supplied in two versions:

- 810C, with a handle latch is rated E/EI60 for approved installation in fire protective doors
- 811C, without a handle latch suits applications in sliding doors or where an automatic door opener is fitted.

ASSA Connect 810C/811C-50(70) are Hi-O units. Hi-O means that the units have a built-in processor and communicate with each other for plug-and-play installation, synchronisation of door operation, supervision of behaviour and to send diagnostic information.

When using an ASSA Connect 81xC in a non-Hi-O environment, each ASSA motor lock requires its own control unit (DAC564) as an interface to superior systems.

Features

- Superior speed gives minimum operating time, less than 1/3 sec
- Cylinder or thumb turn provides mechanical override in case of power loss or other malfunction
- 50 mm or 70 mm (81xC-50 and 81xC-70 respectively) backset option
- Built-in DMS (door monitoring switch)
- Provides the control unit free communication with other Hi-O units

The control unit DAC564:

- Interface towards non-Hi-O systems, e.g. access control or burglary alarm systems
- Provides Hi-O communication to the motor lock
- Requires control signals from systems to operate the motor lock
- Supplies systems with information about lock and door status
- Provides external DMS input; to replace or complement the internal DMS
- Operates a non-Hi-O daytime lock; to create a high-security and frequently used day/night combination
- Buzzer output, activated when faults occur.
- Connected to power supply
- Installed on the secure side, within 10 m from the motor lock
- Connected to an ARX access control system, a totally integrated and highly flexible system is provided



Accessories for electromechanical locks

Brackets ASSA 507/17, 507/22, 507/26, 510/511

Type	Length (mm)	Width (mm)	Wrap-around (mm)	Lip width (mm)
ASSA 507/17	400	45	20	17
ASSA 507/22	400	50	20	22
ASSA 507/26	400	55	20	26
ASSA 510/511	300	43	20	14

Strike plates ASSA

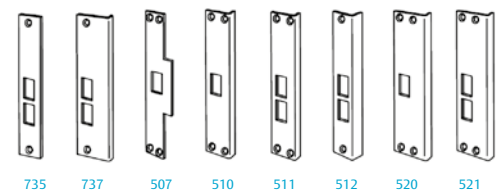
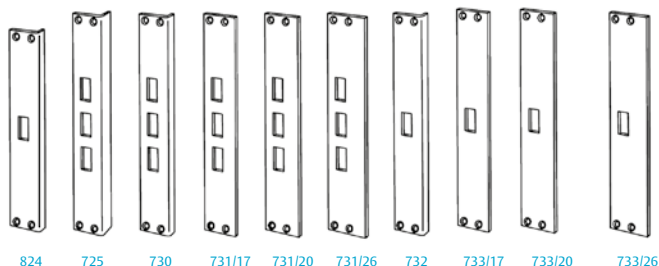

Blind faceplates ASSA

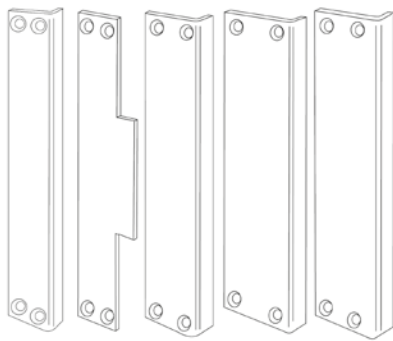

ASSA 824 ASSA 507 ASSA 510 ASSA 520 ASSA 521



Cable loop

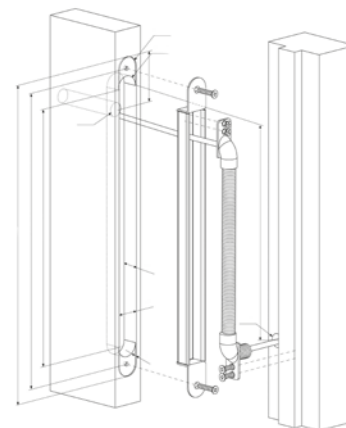

Cable loop EA280, EA281

Application

The EA280/EA281 recessed cable loops are for transferring cables from frames to doors; suitable for swing doors only.

Features

Install EA281 if the opening angle exceeds 120° or if the coil spring parallel dislocation exceeds 40 mm. Cable diameter max Ø 7.4 mm; flexible cable maintains performance.

Function

Cable loop installation; housing preparation in the upper part on the hinge side of the door, coil spring flange of the corresponding height on the frame, the cable must be pulled through before fastening. The preparation must be wide enough to allow the cable to flex under the housing and coil spring flange.

NB!

One cable in each door loop only.

ASSA 83

Application

Cable loops made of nickel-plated brass with white plastic fixings are for transferring cables from frames to doors; suitable for swing and slide doors. Supplied with plastic bushings to avoid abrasion. Cable diameter max Ø 6 mm; flexible cable maintains performance.

Function

Cable loop installation; in the upper part on the hinge side of the door and frame; before fastening, the cable must be pulled through.

Technical specifications

ASSA 83 Length: 400 mm
 ASSA 83/600 Length: 600 mm
 ASSA 83 is also available by the meter and plastic fixings and bushings are available individually.

NB!

One cable in each door loop only to avoid extensive wear.

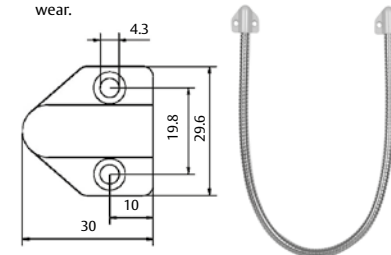

Dimensions in mm, not proportional



Door contact and connecting cables



Door contact ASSA 88

Application

ASSA 88 transfers power and electrical signals from frame to door.

Features

4-pole power transfer made of grey plastic with sprung balls.

Technical specifications

Distance Max 5 mm gap between door and frame
Current/Voltage 500 mA @ 24VAC/VDC

NB!

NOT recommended for motor lock applications. Were to loss of communication when door is opened.

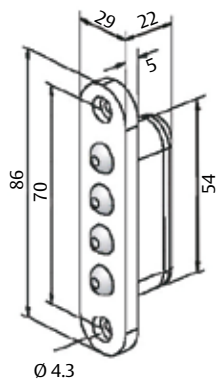

Dimensions in mm, not proportional

Connecting cables ASSA EA225, ASSA 81 71 21, 81 71 22

ASSA flexible cables are supplied with attached connectors to transfer signals and power from locks to superior systems.

Every electro-mechanical lock requires a designated cable, see the table below. ASSA cables are designed to withstand demanding environments, such as a door exposed to major differences in temperature.



Connecting cables to ASSA motor, solenoid handle and microswitch locks			
Cable type	Length	Designated for	Replaces
EA225	10 m	All ASSA motor locks	EA215
81 71 21	10 m	All ASSA solenoid handle locks	EA210, EA220
81 71 22	10 m	All Connect mechanical locks with built-in microswitch	



Bolt contacts



ASSA 82



ASSA 878



ASSA 876/877

ASSA 82, 876, 877, 878, 8400, 8410

Application

Bolt monitoring switches are designed to monitor a latch or bolt throw. Various uses e.g. fire protective and emergency exit doors; free/occupied monitoring in lavatories.

Features

- ASSA 82 Dead or latch bolts; throw 10–24 mm
Designated fixing, attached to security strike reinforcement box
- ASSA 876 Dead or latch bolts; throw 16–20 mm
Designated fixing, back of strike plate
- ASSA 877 Dead or latch bolts; throw 12–15 mm
Designated fixing, back of strike plate
- ASSA 878 Dead bolts; throw 5 mm–infinity
Designated fixing, back of strike plate

Technical specifications

- Microswitches Changeover NO/NC, rated 1A @ 24VAC/VDC, max 24W
- Waterproof ASSA 878 Insulation protection, IP54

Measurements				
Type	Height	Width	Depth	Misc.
ASSA 82				
ASSA 876	68 mm	18 mm	34 mm	-
ASSA 877	68 mm	18 mm	30 mm	-
ASSA 878	55 mm	11 mm	43 mm	Cable 4 m



Magnet contact



ASSA 41



ASSA 42/43

ASSA 41, 42, 43

Application

A magnet contact to monitor door position is attached to the door and frame.

Features

ASSA 41 surface-mounted magnetic contact
ASSA 42 biased high-security recessed magnetic contact
ASSA 43 recessed magnetic contact

Technical specifications

Loop type NO
Current/Voltage Rated 500 mA @ 48 VAC/VDC,
max 7.5 W

Measurements				
Type	Measurements	Drill size	Max gap	Connection
ASSA 41	L 64 × B 16 × H 13 mm		19 mm	Screw terminal
ASSA 42	L 40 × Ø 25 mm	Ø 19 mm	10 mm	2 m cable with tamper loop
ASSA 43	L 40 × Ø 25 mm	Ø 19 mm	22 mm	2 m cable with tamper loop



Heating tape, thermostat and protective diode



Heating tape



Thermostat



Protective diode

Heating tape

Application

Self-adhesive heating tape to connect to electric strikes, solenoid handle locks or motor locks to maintain operation in extreme environments.

Technical specifications

Voltage 12/24 VAC/VDC, 2.5 W
Measurements 30 mm x 90 mm,
200 mm connecting wires

Thermostat

Application

Bimetallic thermostat to regulate heating tape above.

Technical specifications

Voltage 12/24 VAC/VDC
Measurements 6 mm x 6 mm x 20 mm

Protective diode

Application

A protective diode protects superior systems from transients (peaks); transients may occur in electric strikes. A protective diode should be connected as close to the coil as possible.

Technical specifications

Type 1N4004



ACCESS CONTROL SYSTEMS

ASSA has many years of experience in developing systems. Our comprehensive product range of door environment solutions allows us to offer a complete solution with both physical security and access control.

Our access control product range includes everything from card and tag readers to, entry phones and central units to user-friendly software with integration capabilities. It also offers adaptability to customer needs for functionality, safety and cost position.

Our products and solutions available today range from simple installations to large, complex access control systems.

ASSA access control systems offer:

- Simple and cost-effective installation in close cooperation with our dealers and installers.
- A good long-term investment. The system can grow as your needs change.
- High security with ASSA products and integration with burglar alarm systems.
- High-quality user-friendly products to make life easier.





LCU9016II

The LCU9016II is a local controller unit in the ARX family that connects directly to the TCP/IP network. The LCU can control up to 16 doors/32 card readers.

The LCU9016II is based on the Linux operating system, has flash memory and can easily be adapted to many future requirements. The LCU9016II will integrate seamlessly in the network and take advantage of existing DNS and DHCP servers.

The LCU9016II is equipped with memory to handle over 100,000 cards and over 1000 schedules, day types and other settings. A separate log-event memory can store more than 30,000 log events.

The LCU9016II can work stand-alone in the event of a network failure. Card holders gain access to doors according to normal rules and log events are stored locally. When the network comes back on line the stored log events are automatically transmitted to the server.

All communication to the server uses PKI certification for authorization and SSL encryption for data protection, which is the same level of security used by Internet banks.

Indications

- Green LED indicators indicate voltage supply
- Blue LED indicator indicate program surveillance
- Green LED indicator indicate network activity
- Red LED indicator indicate communication with loop board

Accessories

- Loop board 4014LC, 4 doors
- Relay board 6416RC, 4 relays of which 3 are software controlled
- Transformer ST60S
- Battery backup



LCU9016II



Function

In the basic configuration the LCU is equipped with one loop board for four doors, each of which can have two card readers (one on each side of the door) and a button. The maximum configuration is 4 loop boards controlling 16 doors.

- Memory with battery backup
- Real time clock with calendar
- Event buffer with capacity to store >30,000 events
- Memory for 100,000 cards with individual PIN codes
- > 1 000 schedules
- Additional functions: Alarm arm/disarm, disabled (extra time for open door), officer function (authority to permanently unlock door)
- SNMP-based supervision

Data

- Power supply: 17-28 V AC or 17-40 V DC
- Temperature range: +5° C <> +40° C
- Weight: 3.0 kg
- Power consumption: 160-350 mA
- Program memory: 16 MB
- Data memory: 16 MB
- Relative humidity: 20-70 %

Article number

- Controller LCU9016II S559 016 2164 E58 762 67
- Loop board 4014LC S554 014 184 E58 760 23
- Relay board 6416RC S556 417 160 E58 760 24

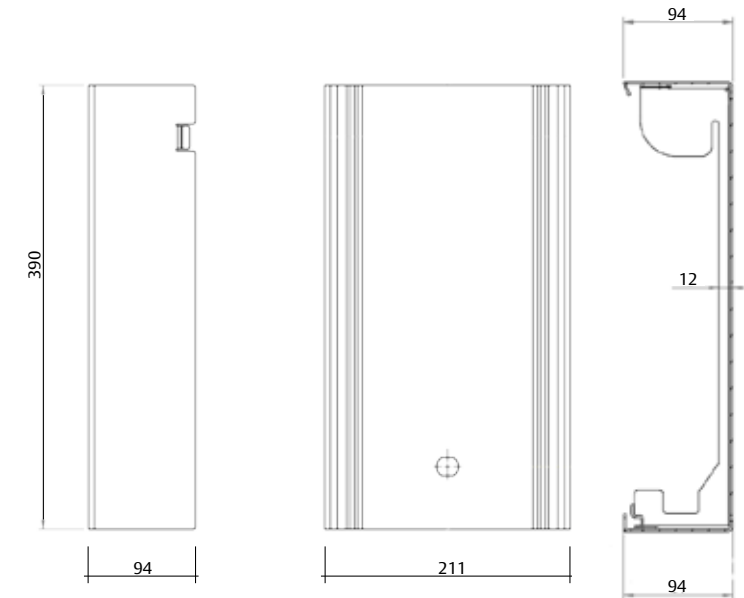
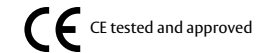

Dimension drawing LCU9016II



LCU9017II

The LCU9017II is a controller unit for the ARX system that is connected directly to an existing TCP/IP network. The controller unit is designed for entry phone ECP30 and ECP35, but also has room for loop boards for controlling door environments.

In the basic design the LCU9017II is equipped with a loop board (9019EM) for connection of two entry phones. The controller unit can be extended in two steps for up to 8 entry phones (with the aid of loop board 9018ES). Slots in the controller unit not used for the entry phones can be furnished with door loop board 4014LC.

The memory capacity can be expanded to allow for over 100,000 cards and practically an unlimited number of schedules, calendars, day types etc. More than 30,000 log events can be stored locally before they need to be transmitted to the ARX server.

The controller unit can work autonomously, i.e. it will work even if the network is down or if the server isn't running. Decisions about door openings are made by the controller unit. The firmware is stored in a flash memory and can be updated from the ARX server.

The security is the highest possible and it uses PKI certificates and SSL encryption. The security solution is patented and unique in the way the controller units are automatically configured at commissioning.

Indications

- Green LED indicators indicate voltage supply
- Blue LED indicator indicate program surveillance
- Green LED indicator indicate network activity
- Red LED indicator indicate communication with loop board

Accessories

- Loop board 4014LC for connection of up to 4 doors
- Loop board 9018ES for connection of up to two ECP30 or ECP35
- Relay board 6416RC, 4 relay outputs of which 3 are software controlled
- Transformer ST60S
- Power supply with battery backup
- Tamper switch 6000SK
- Key Alike 6000LL



LCU9017II

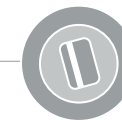

Function

- Log memory with battery backup
- Real time clock with calendar
- Event buffer > 30,000 events
- Time schedules > 1 000
- Caretaker function, disabled function and alarm manoeuvre can be controlled.

Data

- Feed voltage: 17 – 28 V AC or 17 – 40 V DC
- Program storage: 16 MB
- Data storage: 16 MB
- Weight: 3.0 kg
- Temperature range: +5°C to +40°C
- Relative humidity: 20-70%

Article number

- LCU9017II S559 017 2164 E58 762 68
- Loop board 4014LC S554 014 184 E58 760 23
- Loop board 9018ES S559 018 160 E58 760 95

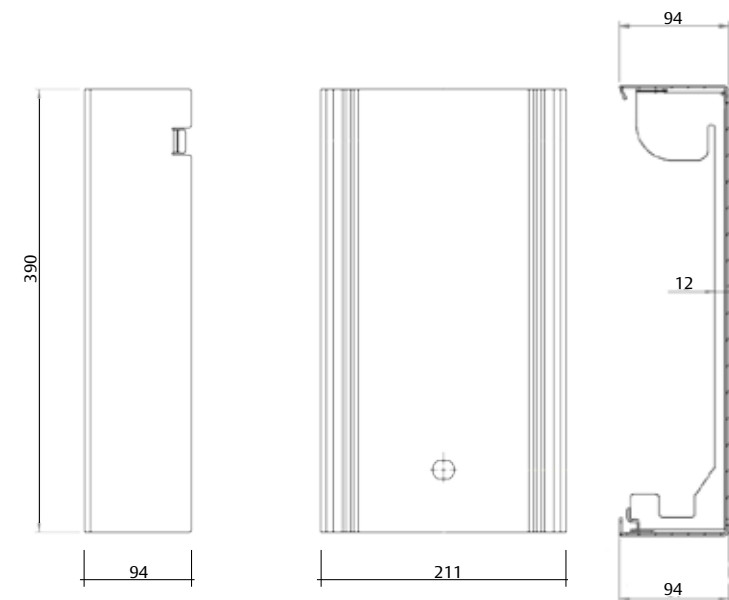
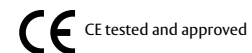



LCU9101

The LCU9101 is a controller for the ARX system that connects directly to an existing TCP/IP network. The LCU9101 manages readers for entry and exit and directly controlled motor locks from ASSA ABLOY's range.

The LCU9101 can be powered separately or via PoE (Power over Ethernet). PoE simplifies installation since no separate cables from the power supply need to be drawn up to the controller. With PoE the controller is powered via an Ethernet connection.

The basic model of the LCU9101 is equipped to manage one door environment including the reader's exit button, electric lock, or motor lock. A card reader or DBL is connected directly to the controller for the first door environment.

Expansion card 9101D3 can be connected to the LCU9101 controller. This card can manage three more door environments via DAC, DBL or PCR. That means a maximum of 4 door environments on one LCU9101.

As the next step to expand an LCU9101, one more expansion card can be connected to the 9101D3 – loop card 9101D3A. Up to 15 wireless door environments with Aperio online readers can be connected to this card, though a maximum of 16 total door environments.

Expansion cards can also be connected to the LCU9101 when additional relays are needed to control automatic doors, or if external Wiegand readers are to be connected to the controller.

Maximum security is achieved since the controller uses ASSA's patented communication solution with PKI certificates and SSL encryption.

The security solution is unique in the way the controllers are automatically configured during startup. After startup the controller can only communicate with the ARX server that has the same certificate, ensuring that no one can access the controller to manipulate the data.

The memory capacity is well developed. The controller can locally manage over 100,000 cards, 30,000 log events and essentially an unlimited number of schedules, calendars and day types.

The controller operates autonomously, which means that all decisions regarding operation modes and accesses are taken directly from the controller. Out in the door environment, the system works the same regardless of whether the server is running.



LCU9101

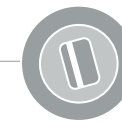

Indications

- Power OK
- Link-ACT
- 100M
- FDx
- WDG
- ARX connect
- Over load
- CL ACT
- Relay activated

Data

- Supply voltage: 17-35 V AC or 24-50 V DC
- PoE (Power over Ethernet): Yes (Refer to manual for choice of lock)
- Current consumption: 100mA at 24V DC
- Max load: 12V out 0.7 A
- Flash memory: 32 MB
- RAM memory: 32 MB
- Number of cards: 100,000
- Operating system: Linux
- Ethernet: 10/100 Mbit
- Weight: 200 g
- Volume: 0.0832 m³
- Temperature range: +5°C to +40°C (non-condensing)

Encapsulation

- Impact resistant PC/ABS plastics SIS166653
- Halogen/Halon free

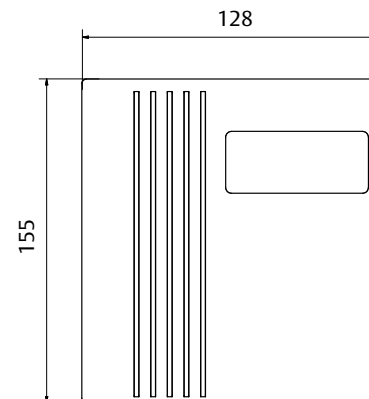
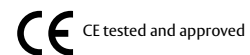

Dimension drawing LCU9101

Example of relay functions in LCU9101 (ADD ON with relay card)

- Time-controlled passage/Timed exit
- Buzzer
- Temporary alarm bypass
- Automatic doors
- Door position indicator
- Monitored mode (motor lock)
- Unlocked mode (motor lock)
- Locked mode (motor lock)
- Electric strikes
- Temporary alarm bypass remains active if door remains open/Temporary alarm bypass that does not fall when door is open too long
- Tamper alarm
- Permanent alarm bypass
- Audio indication of alarm bypass
- Balanced EXIT/SAB
- Balanced EXIT/ALARM
- Door opener for disabled persons/Handicap exit
- Exit/Entry
- Invalid card/code
- Reflect day/night mode without motor lock
- Day alarm: The relay remains energized with forced pull on door

Article number

- LCU9101 S559 101 185 E58 760 84
- 9101D3 S559 101 3160 E58 762 50
- 9101D3A S559 101 3161 E58 762 51
- 9101R4850 S559 185 160 E58 762 52
- Relay card 9101RC64 S559 164 160
- 500RW22 S556 652 2160 E58 700 87

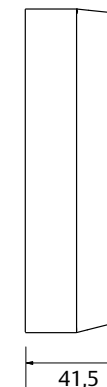



Upgrade to a modern system - reuse the materials you have already invested in

We invite you to update your existing RiTA access control system to the next generation of security systems, the ARX Access control system. You can read more about ARX Access control systems in our brochure, "ARX On-Line Access control systems," which is available from your dealer.

When you upgrade from RiTA to ARX, you can keep the existing products and cabling for the door environments. Scanners, locks and other door-related equipment work just as well in ARX as they do in RiTA. This is where the greatest savings are realized compared with replacing the entire system.

You can migrate users, cards and authorizations. An access control system contains a great deal of information, and your users, their cards and their authorizations can of course be exported from RiTA and imported into ARX.

If a customer does not wish to or cannot convert his entire installation at once, RiTA and ARX can be run together. The administrative tasks are handled in ARX, and the changes and additions are then transferred to RiTA automatically.

6300/6304

In addition to a new CPU card, the package for upgrading 6300 and 6304 central control units includes a connecting card with terminal blocks that are identical with the ones in the old control units. This makes the upgrade process very simple: disconnect the terminal blocks, unscrew the old card, install the new cards and connect the terminal blocks. The only new component that needs to be installed is a network cable for the CPU card.

If there is more than one central control unit in the same location, up to four connecting cards can be handled by a single CPU card.

Clients - Replace

Server - Replace

Substations - Upgrade

Door environments - keep

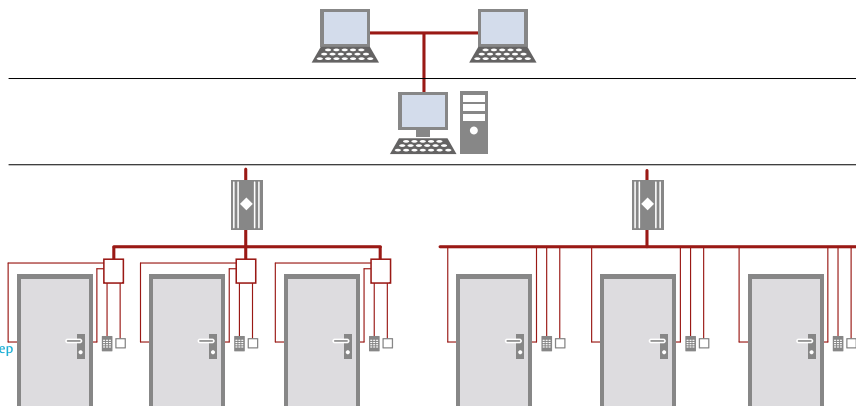

6416

With its separate DACs, the 6416 is more like an ARX central control unit, making it even easier to upgrade a 6416 to ARX. The upgrade package contains a new CPU card and the first loop card, with terminal blocks that are identical with the old ones. This makes the upgrade process extremely simple: disconnect the terminal blocks on the first loop card, unscrew the old CPU card and the first loop card, install the new cards, and connect the terminal blocks. The only new component that needs to be installed is a network cable for the CPU card.

Everything is included

The packages include everything needed to upgrade a substation: cables, screws and door licenses for ARX. There will be no unpleasant surprises.

Article number

- Upgrade package 9104 Master (includes 1 9016C CPU board, 1 DAC44, installation details and 4 door licenses) S55 6644 000 E58 700 49
- 9104 Slave (includes 1 DAC44, installation details and 4 door licenses) S55 6645 000 E58 700 50
- 6416 to 9016 4 DL (includes 1 9016 CPU board, 1 9014 base loop board and 4 door licenses) S55 661 6001 E 58 700 51
- 6416 to 9016 8 DL (includes 1 9016 CPU board, 1 9014 base loop board and 8 door licenses) S55 661 6002 E58 700 52
- 6416 to 9016 12 DL (includes 1 9016 CPU board, 1 9014 base loop board and 12 door licenses) S55 661 6003 E58 700 53
- 6416 to 9016 16 DL (includes 1 9016 CPU board, 1 9014 base loop board and 16 door licenses) S55 661 6004 E58 700 54

Upgrading 6300/6304

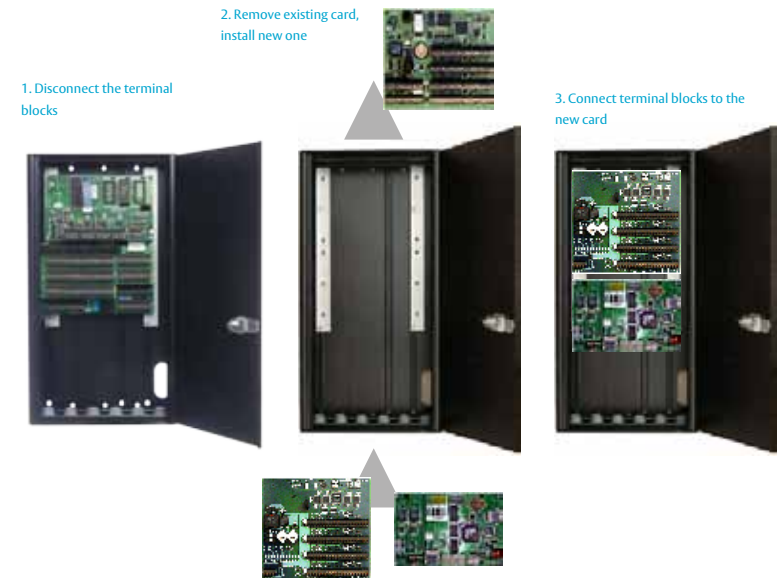

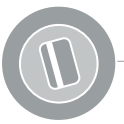

RX WEB – the most flexible web-based control systems on the market



RX WEB – fast, easy and cost-effective
RX WEB is a smooth and easy-to-use access control system for up to 16 doors, ideally for small or growing companies. You can easily manage the system from any computer in the network.

RX WEB is fast
You don't have to install any software, because it is already installed in the control unit, where the database is also stored. You also don't have to buy any licenses. This makes planning and installing RX WEB much faster than with many other access control systems. Connect the control unit to the network, log in to RX WEB control unit via an Internet browser, and you are ready to go.

RX WEB is easy
The software is intuitive and easy to learn, and you only need to connect via a Web browser. It cannot get any easier!

RX WEB is cost-effective
Many smaller companies have only a few doors, and it would be nice to find a cost-effective solution for a customized access control system. You can also connect up to 15 door environments with ASSA's wireless Aperio reader. You can use this in, e.g., a corridor with doors to office rooms.

RX WEB function
Once readers, exit buttons and electrical locks are installed and connected, you can connect the control unit to the network, where it is assigned an IP address. This is the address that you use to communicate with the hardware through your regular Internet browser.

The access control system has a calendar, which means that you can have different access rules depending on the day of the week. In other words, you can have different security levels for the doors, everything from unlocked to requiring a card and PIN code code for access, or only allowing access at certain times. The events are stored in a log, which can be displayed in real time.

The program allows you to select the appropriate security level for each door. You can also control alarms directly from the card reader using a valid card. A number of different reading technologies allow you to connect to the control unit, such as Magnet, EM prox, Mifare and Wiegand. You can also connect an automatic door opener to provide access for people with disabilities.

RX 9101 can be configured with several different combinations of loop cards, depending on the number of door environments, see the reverse.

RX9101

- Data**
- Supply voltage: 17–35V AC or 24–50V DC
 - PoE (Power over Ethernet): Yes (See manual for choice of lock)
 - Power consumption: 100mA at 24V DC
 - Max load 12V: out 0.7 A
 - Flash memory: 32 MB
 - RAM memory: 32 MB
 - Number cards: 100,000
 - Operating system: Linux
 - Ethernet: 10/100 Mbit
 - Weight: 200 g
 - Temperature range: +5°C to +40°C (non-condensing)

- Case**
- Impact resistant PC/ABS plastic

- Article number**
- Controller RX9101 S559 101 2085 E58 762 49
 - Loop card 9101D3 S559 101 3 160 E58 762 50
 - Loop card 9101D3A S559 101 3 161 E58 762 51
 - Loop card 9101R4850 S559 185 160 E58 762 52

- Note**
- For door environment No. 1 connect the reader, electrical lock and exit button, etc. directly to the control unit RX9101. DAC/PCR cannot be connected.
 - 9101D3A can only be connected to 9101D3.
 - On loop card 9101D3A and 9101R4850, connect Aperio reader via ComHub with RS485, not RadioDAC.
 - For door environment 2-4 on 9101D3, connect DAC/PCR/DBL.



RX9101

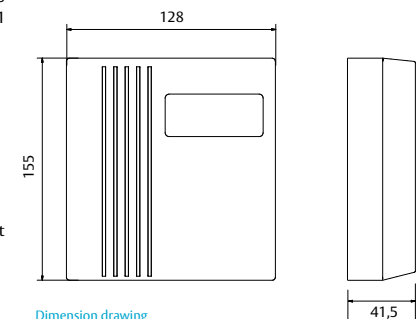

Dimension drawing

Controller	RX9101	RX9101	RX9101	RX9101
Loop card	-	9101D3	9101D3 9101D3A	- - 9101R4850
Number of door environments, wired	1	4 (1+3)	4 (1+3)	1
Number of door environments, Aperio (RS485)	-	-	12	15
Number of door environments, total	1	4	16	16

RX9101 can be configured many different ways depending on how many door environments the system needs.



RX9016II

RX WEB - the most flexible web based access system on the market

RX WEB is a flexible and easy to use access control system for up to 16 doors which is suitable for the smaller or growing company. Both the access control software and database are stored in the control unit so you don't have to install any PC software. The control unit is allocated its own IP address which means the system can be controlled from any computer on the network using its normal internet browser. If the company grows you can easily expand the system with extra control units and doors without having to change any of the existing door installations.

The access system has a calendar so access permissions can vary depending on the time and the day of the week. For example, a door may be unlocked for part of the day, then require a card read at other times, and a card read plus a PIN code during the night or at weekends. All events are saved in a log, which can be displayed in real time.

With the RX WEB system you will always be able to expand

Because system administration is performed via the network without any software installation in the computer, you can handle the system from any computer. The fact that all communication with RX is made via the existing network in the company minimises the cabling. An RX WEB system never limits you when you wish to expand the number of doors: it is always possible to grow to ARX without changing any hardware installation. Furthermore, most existing 4 000 systems are easy to transfer to an RX control unit, without changes to the door installations.

The program makes it easy to select an appropriate security level for each door, depending on the day and time. Intruder alarms can be enabled or disabled directly from the card reader using a valid card.

A number of different reader technologies can be connected to the control unit, such as Mag Stripe, Mifare and Wiegand. It is also possible to connect a door opener to facilitate access for the disabled.



RX9016II



Indications

- Green LED indicates supply voltage
- Blue LED indicates program surveillance
- Green LED indicates network activity
- Red LED indicates communication with loop board

Accessories

- Loop board 4014LC, for connection of up to 4 doors
- Relay board 6416RC, 4 relay outputs of which 3 are software controlled
- Transformer ST60S
- Battery backup
- Tamper Switch 6000SK
- Equal locking 6000LL

Data

- Power supply: 17 – 28 V AC or 17 – 28 V DC
- Program storage: 16 MB
- Data storage: 16 MB
- Weight: 3,0 kg
- Temperature range: +5°C to +40°C
- Relative humidity: 20 – 70%

Functions

- Log memory with battery backup
 - Real time watch with calendar
 - Event buffer > 30 000 events
 - Time schedules 16
- Unlocked door, caretaker function, disabled function and alarm manoeuvre can be controlled from connected readers.

Article number

- Controller RX9016II S558 916 2164 E58 762 69
- Loop board 4014LC S554 014 184 E58 760 23
- Relay board 6416RC S556 417 160 E58 760 24

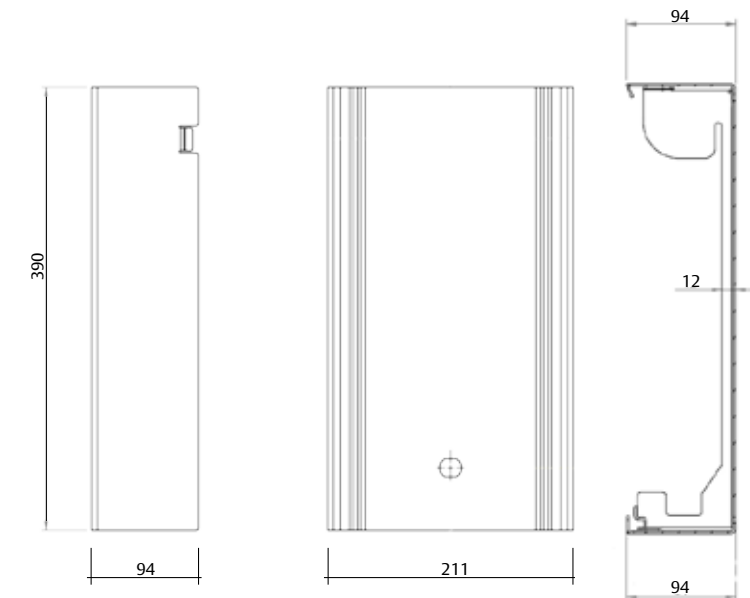
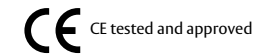

Dimension drawing



LCU6516II

The LCU6516II is a controller unit that can manage up to 16 door environments/32 card readers. It has a large memory capacity and can be adjusted for several different usage areas.

Each door is fitted with a DAC, to which you can connect a reader, lock, exit button, etc. This lets you create the same solution regardless of door type and equipment, and also makes it possible to add equipment to the door afterwards, such as a directly controlled motor lock.

The LCU6516II has a large memory as standard, which means that the software lets you manage up to 73,000 cards and 63 schedules, and store 250,000 characters in the log event buffer, resulting in 30,000 saved door transactions.

The controller units work autonomously. Having a system with distributed intelligence gives added security, because the entire system is not disabled if wires break in one of the control units.

The number of doors can be expanded with the easy installation of additional loop boards and a DAC.

This is what is called a "split installation", which means that all intelligence is on the locked side of the door, out of reach from sabotage of the outside. This provides very high security.

Function

In the basic design, the control unit is intended for four doors with one DAC per door, which in turn can be furnished with two readers and an exit button.

Fully equipped, it enables the connection of 16 doors.

- Memory with battery backup
- Real time clock with one-year calendar
- 30,000 events in the event buffer (250,000 characters in the buffer)
- 73,000 cards, locally with individual PINs
- 63 time schedules
- Elevator function as default
- Function: Alarm authority, disabled function, caretaker function and unlocking by card/tag reader.



LCU6516II



Function in combination with DAC:

Set unlocked mode, unlocking from reader without keypad, alarm card, disabled function, caretaker function, unconditional alarm activation, free control of alarm zones and alarm authorities, buy alarm time, pre-alarm at alarm activation, ABP as pulse, selection of what to be blocked at alarm, selectable alarm status, real time display of alarm status, two-card function, day/night function support, immediate unlocking or after first passage, function controlled relays in DAC, PIN code as common code and card number as common code.

Data

- Power supply: 17 – 24V AC/DC
- Weight: 3.0 kg
- Temperature range: +5° to +40° C

Controlled with

- PC with Windows software

Accessories

- Loop board 4014LC, 4 doors/boards for connection to DAC430II
- Relay board 9016RC, 4 relays of which 3 are software controlled
- Signal transducer CL-20
- Transformer ST60S
- Excess voltage limiting device Z-01, Z-02

Article number

- LCU6516II 5556 516 2164

CE CE tested and approved

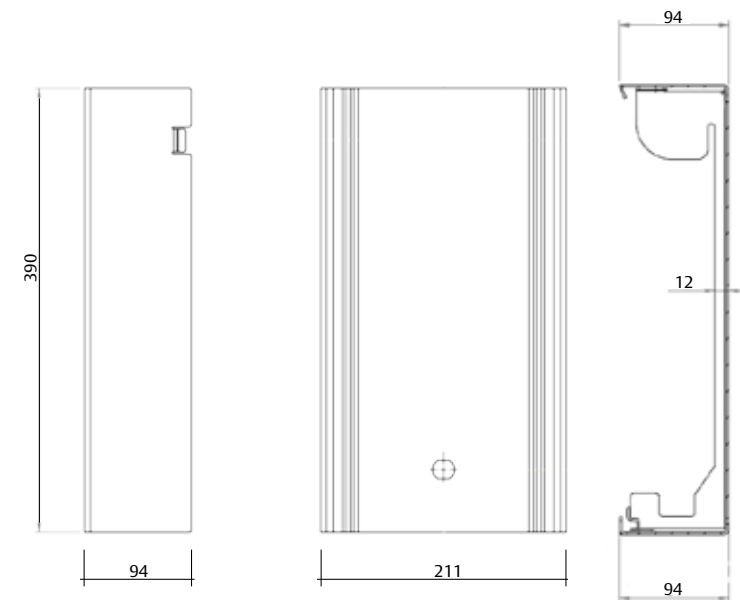

Dimension drawing LCU6516II



DAC430II

The DAC430II is a communication unit and an intelligent connection terminal block intended to be fitted at each door. An electric lock, a motor lock, a reader, an alarm and an exit button can be connected to each unit.

The DAC430II has built-in motor lock control functionality.

Casing

- Impact-resistant PC/ABS plastic
- Halogen/Halon free

Data

- Feed voltage: 12-24 V AC/DC
- Max current: 12 V DC 55 mA
24 V DC 40 mA
- Weight: 200 g
- Volume: 0.0832 m³
- Temperature range: +5°C to +40°C (non-condensing)

Relay functions DAC430II (with relay card)

- Time-controlled output
- Buzzer
- Temporary alarm bypass
- Door automation
- Door leaf position
- Monitored mode (motor lock)
- Unlocked mode (motor lock)
- Locked mode (motor lock)
- Electric strike plate
- Temporary alarm bypass that stays active when door is open too long
- Tamper
- Permanent alarm bypass
- Pre-alarm at alarm bypass
- Mirror blocking input in zone
- Balanced OUT/SAB
- Balanced OUT/ALARM
- Disabled output
- Unconditional buzzer output
- Follows day mode (motor lock)
- Door automation with IR/radar
- Out passage
- In passage
- Invalid card/code



DAC430II

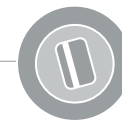

Accessories

- Relay board 400RC64 - Relay board with 6 programmable relays and 4 inputs
- Relay board 500RW22 - Relay board/interface with 2 relays and 2 inputs, Wiegand interface for two OEM readers, in/out

Article number

- DAC430II S556 640 2085 E58 701 11
- Relay board 400RC64 S556 651 160 E 58 760 12
- Relay board 500RW22 S556 652 2160 E 58 700 87

Compatible reader technologies

- EM4102, Mifare, CL/DATA (Magnetic) and Wiegand

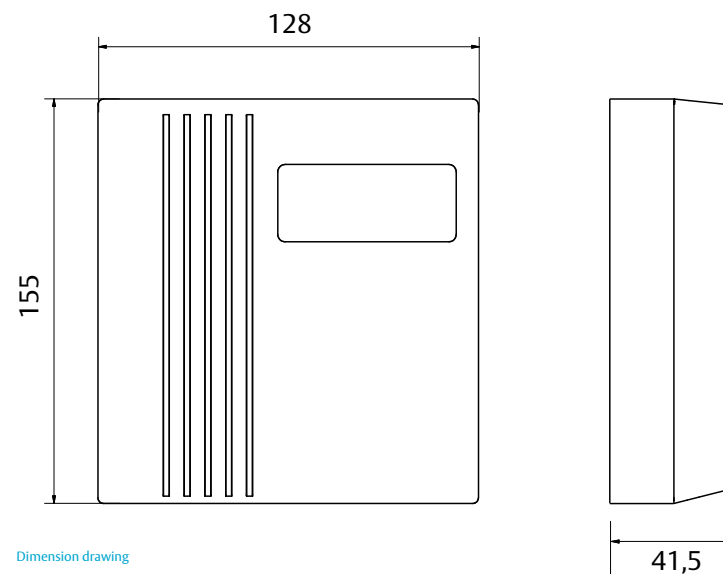
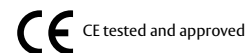

Dimension drawing



DAC530II

The DAC530II is a communication unit and an intelligent connection terminal block designed to be fitted next to each door environment. An electric lock, reader, exit button and so on are connected to each unit.

The DAC530II is a Hi-O unit that can be connected to a Hi-O bus, but it can also be used as a traditional DAC and connected to non-Hi-O units, such as a reader, electric lock and exit button.

Hi-O means that the units have a built-in processor and communicate with each other for plug-and-play installation. Hi-O enables intelligent supervision of door behavior, in real time.

The DAC530II has built-in function for Hi-O motor locks.

Casing

- Impact-resistant PC/ABS plastic
- Halogen/Halon free

Relay functions DAC530II (with relay card)

- Time-controlled exit
- Buzzer
- Temporary alarm bypass
- Automatic door controls
- Door leaf position
- Electric strike plate
- Temporary alarm bypass connection that falls if the door is open too long
- Sabotage
- Reflects blocking input in zone
- Prealarm for alarm by-pass
- Balanced UT/SAB
- Balanced UT/ALARM
- Disabled exit
- Unconditional buzzer output
- Door automatic controls with IR/Radar
- Exit
- Entry
- Invalid card/code
- Permanent alarm bypass connected via relay card

Data

- Voltage supply: 12 – 24 V AC/DC
- Maximum power consumption: 12 V DC 55 mA
24 V DC 40 mA
- Weight: 200 g
- Volume: 0.0832 m³
- Temperature range: +5°C to +40°C (non-condensing)
- Number of inputs: 2 (1 for exit button, 1 for door monitoring)
- Number of outputs: 2 (1 for alarm by-pass, 1 for electric lock control)



DAC530II



HI-O TECHNOLOGY™

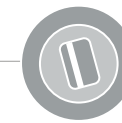

Compatible reader technologies

- EM4102, Mifare, CL/DATA (Magnetic) and Wigand

Accessories

- Relay card 400RC64 - Relay card with 4 inputs (3 double balanced, 1 as blocking input) and 6 outputs (4 is configurable, 1 for alarm control, 1 for schedule control)
- Relay card 500RW22 - Relay card/interface with 2 relays and 2 inputs, Weigand interface for two OEM readers, in/out

Article number

- DAC530II S556 6650 2085 E58 701 09
- Relay card 400RC64 S556 652 2160 E58 760 12
- Relay card 500RW22 S556 652 160 E58 700 87

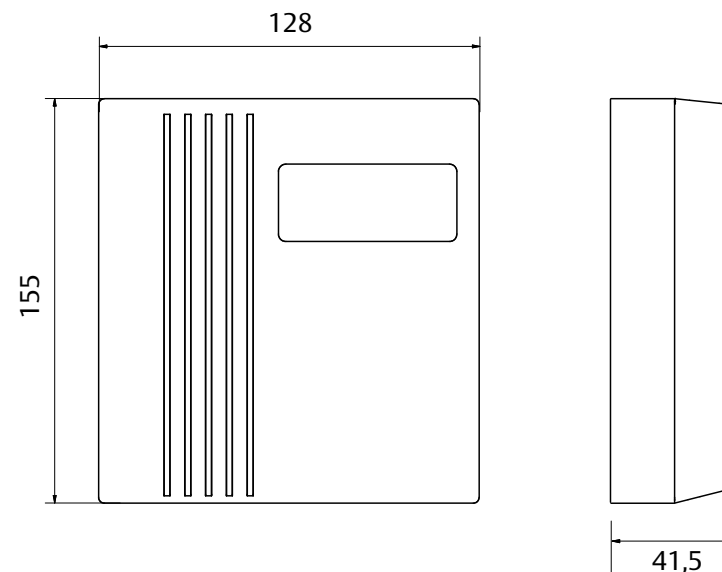
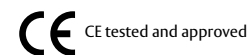



DAC564II

The DAC564II is a communication unit and an intelligent connection terminal block designed to be fitted next to each door environment. An electric lock, reader, exit button are connected to each unit.

The DAC564II is a Hi-O unit which can be connected to a Hi-O bus, however it can also be used as a traditional DAC and connected to non-Hi-O units, such as reader, electric lock and exit button.

Hi-O means that the units have a built in processor and communicate with each other for plug-and-play installation. Hi-O enables intelligent supervision of door behaviour, in real time.

DAC564II has a built-in motor lock controller for Hi-O motor locks.



DAC564II



HI-O TECHNOLOGY™

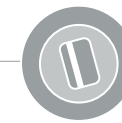

Enclosure

- Impact-resistant ABS plastic according to SIS 166653
- Halogen/Halon free

Relay functions DAC564II

- Time-controlled exit
- Buzzer
- Temporary alarm bypass
- Automatic door controls
- Door leaf position
- Electrical striking plate
- Temporary alarm bypass connection that falls if the door is open too long
- Sabotage
- Reflects blocking input in zone
- Pre alarm for alarm by-pass
- Balanced UT/SAB
- Balanced UT/ALARM
- Disabled exit
- Unconditional buzzer output
- Door automatic controls with IR/Radar
- Exit
- Entry
- Invalid card/code
- Permanent alarm bypass connected via relay card

Data

- Voltage supply: 12 – 24 V AC/DC
- Maximum power consumption: 12 V DC 55 mA
24 V DC 40 mA
- Weight: 200 g
- Volume: 0.0832 m³
- Temperature range: +5°C to +40°C (non-condensing)
- Number of inputs: 6 (3 double balanced, 1 for exit button, 1 for door monitoring, 1 for blocking input)
- Number of outputs : 8 (1 for alarm by-pass, 1 for electric lock control, 1 for schedule control)

Compatible reader technologies

- EM4102, Mifare, CL/DATA (Magnetic) and Wigand

Article number

- DAC564II 5556 656 2085 E58 701 10

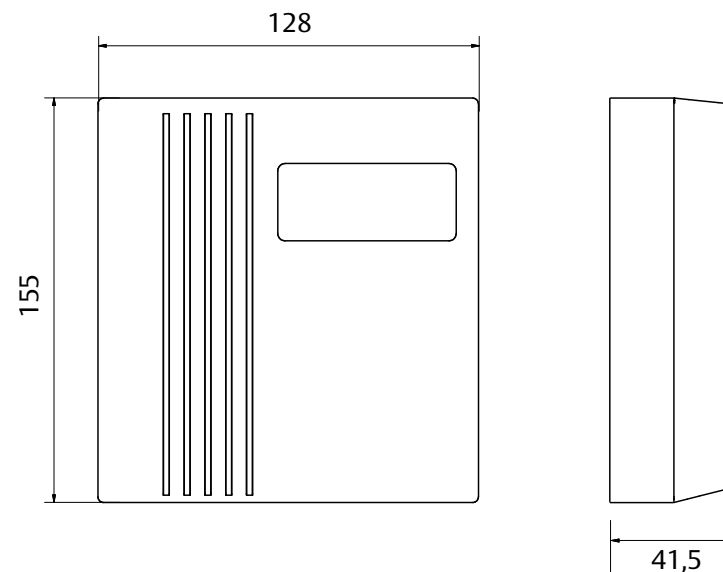
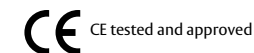

Dimension drawing



DBL340

The DBL340 is a compact door lock reader for proximity cards and tags. Because all the electronic circuitry is securely housed inside the strong metal case and only the antenna is on the outside, the reader is extremely tamper-resistant.

The DBL340 reader comprises the reader unit and an ABLOY EL980 electric lock with a split spindle. There is no need to drill extra holes in the door to mount the lock case or the reader, because the cabling can be routed either on the inside or outside of the door. When you order the reader, you can choose whichever style of door handle and lock cylinder that you prefer.

The DBL340 reader is primarily designed for use on interior doors to slow people down and stop them from running in the corridors, rather than for high security applications (there is no requirement for users to enter a personal code, for example).

Examples of such applications include locker rooms, warehouses, interior doors, basement stores and offices. All programming of the system is carried out using ARX, RX WEB or RiTA software, and all configuration data is stored in a central database.

There are many advantages to centrally controlled door lock readers. They are easy to manage because individual cards can be disabled instantly from the access control system to prevent them from gaining access. The access control system also maintains a log file containing all the most recent events and card transactions.

Installation is made easy because the DBL340 has a built-in door control unit (DAC) which communicates directly with the central unit of the access control system.

The DBL340 is environmentally friendly, with no PBB or PBDE in its circuits.



DBL340

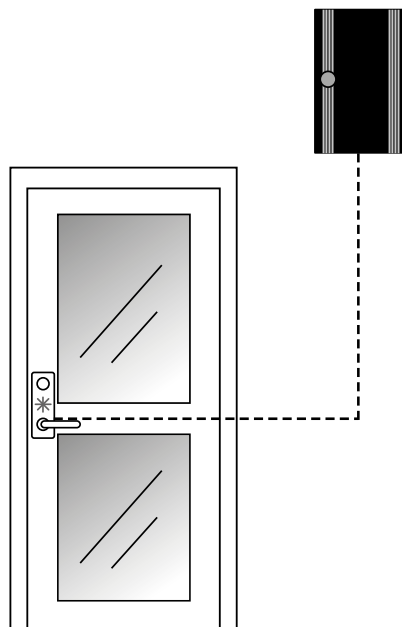

Indications

- Door unlocked/valid access—blue
- Door locked/invalid card—red

Data

- Supply voltage: 15-30V AC/DC
- Power consumption: at 24V, 30 mA
- Consumption when unlocked: at 24V, 150 mA
- Weight: 1.5 kg including lock case
- Temperature range: -20°C to +65°C
- Relative humidity: 20-70%
- Reader technology: EM4102
- IP54 compliant

Can be connected to

- Can be directly connected to the ARX, RX WEB or RiTA access control systems

Other features

- Reversible
- Right or left-opening
- Built-in tamper contact
- Moulded covers

Material

- Brushed chrome

Article number

- DBL340 with lock case S556 718 000 E58 762 28 (right/left-opening)

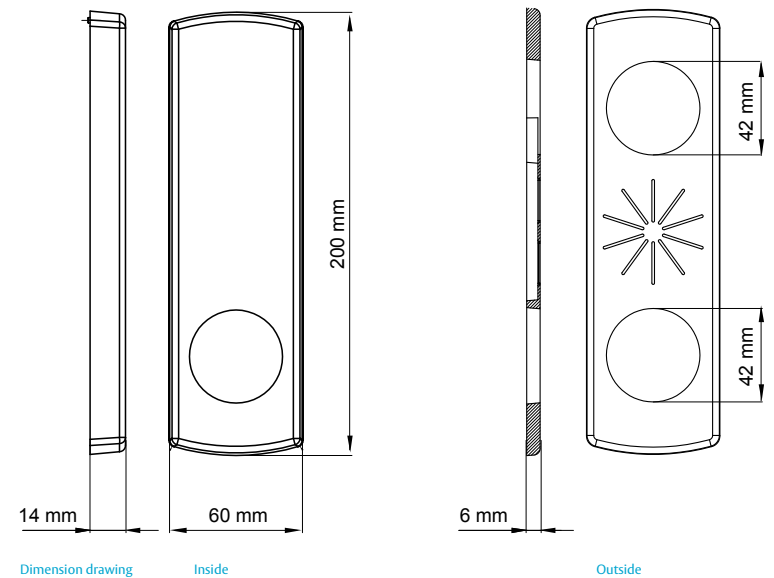
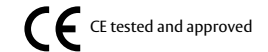



DBL342

The DBL342 is a compact door leaf reader for proximity cards and tags. The reader is safe from manipulation because all the intelligence is securely located on the inside and only the antenna is on the outside.

The DBL342 has a door-handle sensor – which the access control system interprets as a built-in Open button – and door position indication via the dead-bolt. It also has an input for an external Open button and an external door position indicator (for example a magnet contact).

The DBL342 reader consists of the reader unit and an ABLOY EL981 electric lock with a split spindle. There is no need to bore extra holes in the door to mount the lock case or the reader, because the wire can be placed on the inside or outside of the door. Select the door handle and lock cylinder of your choice to go with the unit.

The DBL342 is primarily used on interior doors intended more to keep people from running in the corridors than for high security (no personal code). Examples of such facilities include locker rooms, internal storage areas, interior doors, basement stores and offices. All programming of the system occurs via ARX, RX WEB or RiTA software, and all configuration data is stored in a central database.

There are many advantages to centrally controlled door leaf readers. They are easy to administrate because individual cards can be instantly deactivated in the system. The most recent events are stored in a log file in the system.

The DBL342 has a built-in door control unit (DAC), which makes installation easy because it connects directly to the central unit in the access control system.

The DBL342 is environment friendly, with no PBB or PBDE in its circuits.



DBL342

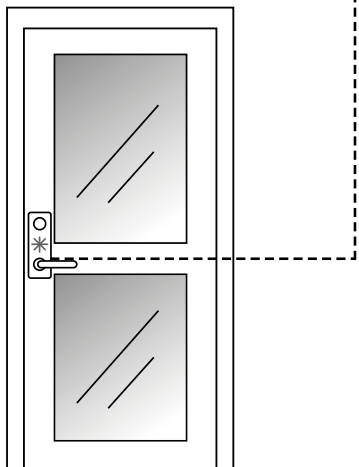
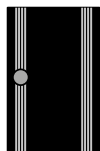

Indications

- Door unlocked/valid access – blue
- Door locked/invalid card – red

Entries/exits

- Door-handle sensor
- Door position indication via the dead locking latch
- Input for external Open button
- Input for external door position indicator (for example magnet contact)

Data

- Feed voltage: 15-30V AC/DC
- Power consumption: at 24V, 30 mA
- Consumption when unlocked: at 24V, 150 mA
- Weight: 1.5 kg including lock case
- Temperature range: -20°C to +65°C
- Relative humidity: 20-70%
- Reader technology: EM4102
- IP54 compliant

Can be connected to

- Can be directly connected to the ARX, RX WEB or RiTA access control systems

Other features

- Fail secure "locked" / Fail safe "unlocked"
- Right or left-opening
- Built-in sabotage contact
- Molded shells

Material

- Matte chrome
- PBB (Polybrominated biphenyl) and
- PBDE (Polybrominated diphenyl ether)-free circuit boards

Product numbers

- DBL342 with lock case S556 718 002 E58 762 29 (right/left-opening)

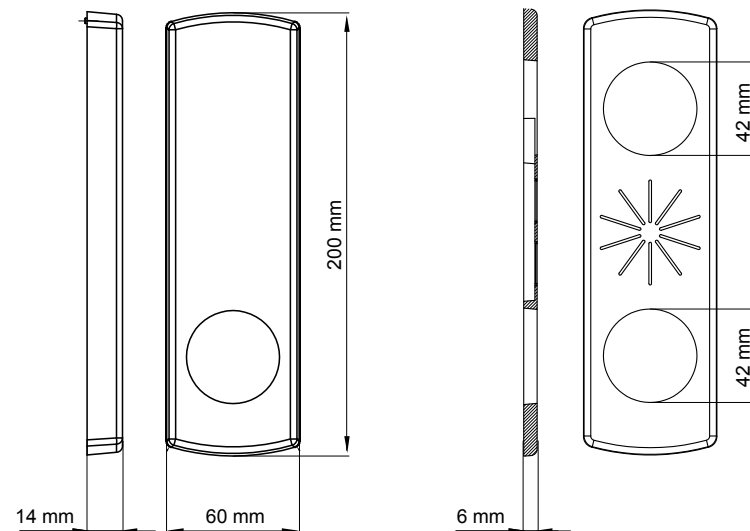
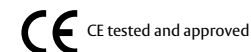

Dimension drawing



DBL350

The DBL350 is a compact door lock reader for Mifare cards and tags. Because all the electronic circuitry is securely housed inside the strong metal case and only the antenna is on the outside, the reader is extremely tamper-resistant.

The DBL350 reader comprises the reader unit and an ABLOY EL980 electric lock with a split spindle. There is no need to drill extra holes in the door to mount the lock case or the reader, because the cabling can be routed either on the inside or outside of the door. When you order the reader, you can choose whichever style of door handle and lock cylinder that you prefer.

The DBL350 reader is primarily designed for use on interior doors to slow people down and stop them from running in the corridors, rather than for high security applications (there is no requirement for users to enter a personal code, for example).

Examples of such applications include locker rooms, warehouses, interior doors, basement stores and offices. All programming of the system is carried out using ARX, RX WEB or RiTA software, and all configuration data is stored in a central database.

There are many advantages to centrally controlled door lock readers. They are easy to manage because individual cards can be disabled instantly from the access control system to prevent them from gaining access. The access control system also maintains a log file containing all the most recent events and card transactions.

Installation is made easy because the DBL350 has a built-in door control unit (DAC) which communicates directly with the central unit of the access control system.

The DBL350 is environmentally friendly, with no PBB or PBDE in its circuits.



DBL350

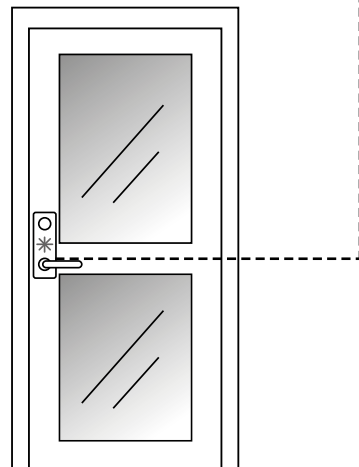
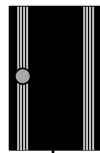

Indications

- Door unlocked/valid access - blue
- Door locked/invalid card - red

Data

- Supply voltage: 17,1 V AC/15-28V DC
- Power consumption: at 24V, 30 mA
- Consumption when unlocked: at 24V, 150 mA
- Weight: 1.5 kg including lock case
- Temperature range: -20°C to +65°C
- Relative humidity: 20-70%
- Reader technology: Mifare, CSN/sector reading
- IP54 compliant

Can be connected to

- Can be directly connected to the ARX, RX WEB or RiTA access control systems

Other features

- Reversible
- Right or left-opening
- Built-in tamper contact
- Moulded covers

Material

- Brushed chrome

Product numbers

- DBL350 with lock case (right/left-opening) S556 722 000

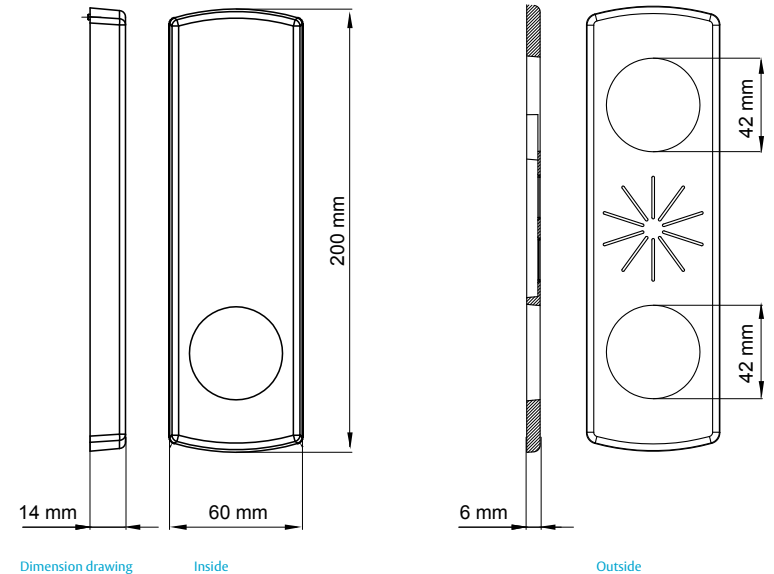
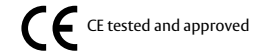



DBL352

The DBL352 is a compact door leaf reader for Mifare cards and tags. The reader is safe from manipulation because all the intelligence is securely located on the inside and only the antenna is on the outside.

The DBL352 has a door-handle sensor – which the access control system interprets as a built-in Open button – and door position indication via the dead-bolt. It also has an input for an external Open button and an external door position indicator (for example a magnet contact).

The DBL352 reader consists of the reader unit and an ABLOY EL981 electric lock with a split spindle. There is no need to bore extra holes in the door to mount the lock case or the reader, because the wire can be placed on the inside or outside of the door. Select the door handle and lock cylinder of your choice to go with the unit.

The DBL352 is primarily used on interior doors intended more to keep people from running in the corridors than for high security (no personal code). Examples of such facilities include locker rooms, internal storage areas, interior doors, basement stores and offices. All programming of the system occurs via ARX, RX WEB or RiTA software, and all configuration data is stored in a central database.

There are many advantages to centrally controlled door leaf readers. They are easy to administrate because individual cards can be instantly deactivated in the system. The most recent events are stored in a log file in the system.

The DBL352 has a built-in door control unit (DAC), which makes installation easy because it connects directly to the central unit in the access control system.

The DBL352 is environment friendly, with no PBB or PBDE in its circuits.



DBL352

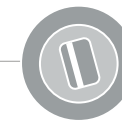
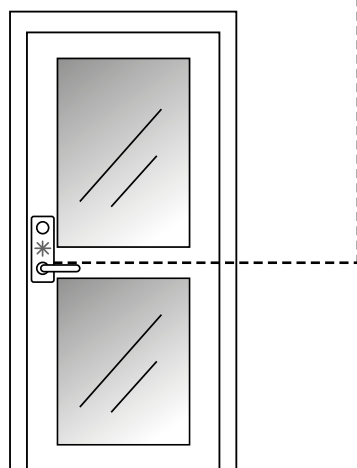
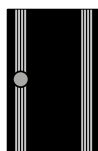

Indications

- Door unlocked/valid access - blue
- Door locked/invalid card - red

Entries/exits

- Door-handle sensor
- Door position indication via the dead locking latch
- Input for external Open button
- Input for external door position indicator (for example magnet contact)

Data

- Feed voltage: 17,1 V AC/15-28V DC
- Power consumption: at 24V, 30 mA
- Consumption when unlocked: at 24V, 150 mA
- Weight: 1.5 kg including lock case
- Temperature range: -20°C to +65°C
- Relative humidity: 20-70%
- Reader technology: Mifare, CSN/Sector reading
- IP54 compliant

Can be connected to

- Can be directly connected to the ARX, RX WEB or RiTA access control systems

Other features

- Fail secure "locked"/Fail safe "unlocked"
- Right or left-opening
- Built-in sabotage contact
- Molded shells

Material

- Matte chrome
- PBB (Polybrominated biphenyl) and
- PBDE (Polybrominated diphenyl ether)-free circuit boards

Product numbers

- DBL352 with lock case (right/left-opening) S556 722 002

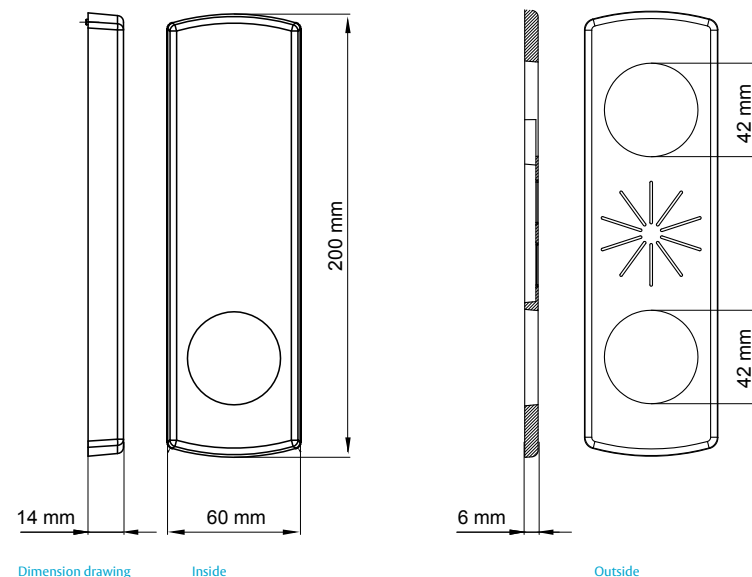
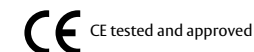



ECP30

The ECP30 is a user-friendly entry phone with an integrated proximity EM reader and code lock. No name signs are need because the entry phone has a lit display showing the names of the residents.

During limited hours, letter carriers, newspaper delivery staff and so on can access the building with a separate code.

The entry phone calls the telephone of the resident. If the visitor knows the apartment number, speed dial can also be used. When the resident picks up, the visitor sees a message in the display showing the floor, apartment number, etc.

The name list in the display and the speed-dial numbers can be scheduled independently of each other to make it possible to turn of the name list at night and then only accept direct calls.

The EPC30 is connected to control unit LCU9017II, which can handle up to eight entry phones. The control unit is a part of the ARX system and is connected to the public telephone net/work/local switch board with a SIP converter.

The entry phone is designed for compact installation, making the installation smooth and cost-effective. Split installation is also an option.

Material

- Silver

Data

- One door for each entry phone
- Feed voltage: 24 V AC/DC
- Power consumption at 24V DC:
 - Stand-by: 50-100 mA
 - Call connected: 500-750 mA
- Weight: 1.3 kg
- Temperature range: +70°C to -25°C
- Reader technology: EM4102

Function

- 1,600 numbers and names per control unit
- 200 numbers and names per entry phone
- 8 common codes
- Schedule-controlled name list in the display
- Speed-dial to the subscribers
- Answer message showing the visitor the floor level when the resident opens the door
- Door monitoring to ensure termination of opening time
- Alarm when door does not close properly



ECP30

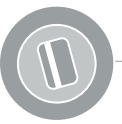

Other

- Key number 5 marked with a dot
- Braille-marked function keys
- Max call time (default 30 sec.)

Can be connected to

- By default, the LCU9017II can manage two ECP30 entry phones. LCU9017II can be extended to up to eight entry phones in steps of two connections with loop board 9018ES.

Article number

- Entry phone ECP30 S556 666 086 E58 760 96
Satin gray
- Controller LCU9017II S559 017 2164 E58 762 68
- Converter from IP (SIP) to standard telecommunication network ECP-IF01
S556 668 999 E 58 760 97
- Extension board 9018ES
for 2 entry phones S559 018 160



CE tested and approved

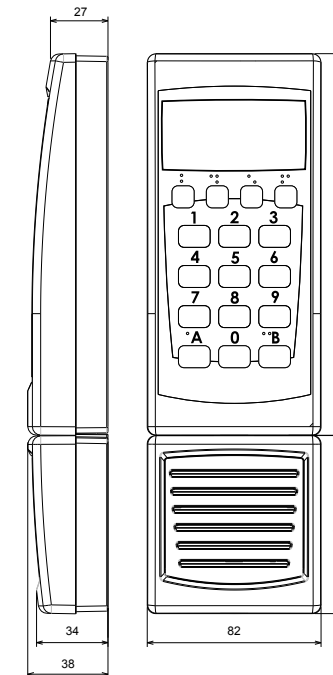

Dimension drawing



ECP35

The ECP35 is a user-friendly entry phone with an integrated Mifare reader and code lock. No name signs are needed because the entry phone has a lit display showing the names of the residents. During limited hours, letter carriers, newspaper delivery staff and so on can access the building with a separate code.

The entry phone calls the telephone of the resident. If the visitor knows the apartment number, speed dial can also be used. When the resident picks up, the visitor sees a message in the display showing the floor, apartment number, etc.

The name list in the display and the speed-dial numbers can be scheduled independently of each other to make it possible to turn of the name list at night and then only accept direct calls.

The ECP35 is connected to control unit LCU9017II, which can handle up to eight entry phones. The control unit is a part of the ARX system and is connected to the public telephone network/local switch board with a SIP converter.

The entry phone is designed for compact installation, making the installation smooth and cost-effective. Split installation is also an option.

Data

- One door for each entry phone
- Feed voltage: 24 V AC/DC
- Power consumption at 24V DC:
 - Stand-by: 50-100 mA
 - Call connected: 500-750 mA
- Weight: 1.3 kg
- Temperature range: +70°C to -25°C
- Reader technology: Mifare CSN/sector reading
- Reader distance: ASSA tagg 0.5- 1 cm
ASSA Card up to 2.5 cm

Function

- 1,600 numbers and names per control unit
- 200 numbers and names per entry phone
- 8 common codes
- Schedule-controlled name list in the display
- Speed-dial to the subscribers
- Answer message showing the visitor the floor level when the resident opens the door
- Door monitoring to ensure termination of opening time
- Alarm when door does not close properly



ECP35



Other

- Key number 5 marked with a dot
- Reader symbol above key number 2
- Braille-marked function keys
- Max call time (default 30 sec.)

Can be connected to

- By default, the LCU9017II can manage two ECP35 entry phones. LCU9017II can be extended to up to eight entry phones in steps of two connections with loop board 9018ES.

Article number

- Entry phone ECP35 Satin gray S556 669086
- Controller LCU9017II S559 017 2164
- Converter from IP (SIP) to standard telecommunication network ECP-IF01 S556 668 999 E 58 760 97
- Extension board 9018ES for 2 entry phones S559 018 160 84 180 34 82 27 38

 CE tested and approved

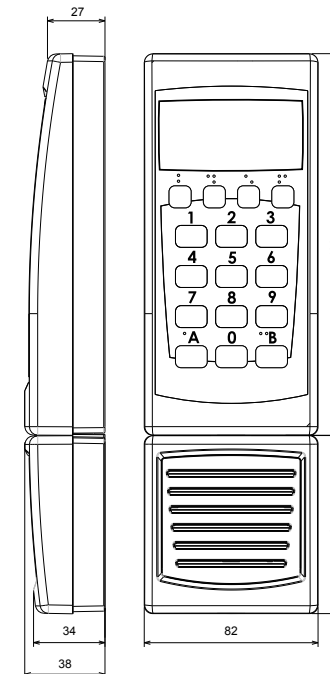

Dimension drawing



7585MF

ASSA 7585MF is a Mifare reader for encrypted sector reading, with built in Hi-O technology. Hi-O means that the units have a built in processor and communicate with each other for plug-and-play installation. Hi-O enables intelligent supervision of door behaviour, in real time.

The Mifare Technology gives a very high security since it uses customer unique encryption keys. With a Set-up card, unique for the site, the readers and credentials (cards and tags) of the system are linked together so only the credentials of the site can be used in the system. Copying and illegal manufacturing of credentials aren't possible, since neither encryption keys nor system numbers are known to unauthorized.

ASSA 7585MF gives a considerable higher security level than readers only reading a serial number (Mifare, EM4102 or magnetic stripe) since those credentials lack encryption and therefore are possible to copy.

ASSA 7585MF has the unique feature of reading Mifare sector data and serial number simultaneously. It is a good feature for customers having both sector encoded cards and cards with only serial number.

ASSA offers as standard Mifare cards and tags with a storage capacity of 1kBit in 16 optional programmable sectors. The reader can also handle cards with 4 kBit and 32 sectors. The Access system uses one sector to store system and card number. Other sectors can be used for other purposes, for example storage of finger print for biometry readers, or debit function for dining rooms and vending machines.

The reader is contactless with a reader range of 5 -7 cm. For easy handling the reader has back-lit symbols, green and red indication for alarm status, and symbols for "enter code" and "present card/tag". The keypad is back-lit and the buttons are made in durable stainless steel.

7585MF has a time-less design and comes in black or white. The reader is suitable both indoor and outdoor, since it meets the demands for IP54.



7585MF



HI-O TECHNOLOGY™



Indicators

- Card reader in operation/ready
- Door unlocked, sound and light
- Door code/code lock function
- Card/tag + PIN code entry
- Entry blocked
- Indicates alarm status for alarm-authorized card/tag
- Invalid card/tag, sound and light

Material

- Poly carbonate
- Halon/Halogen-free
- Cast bottom plate
- Meets the requirements for IP54

Data

- Voltage supply: 12 V DC
- Power consumption: 100 mA
- Weight: 0,4 kg
- Temperature range, reader: -25°C to +70°C
- Read technology: Mifare
- Communications: Hi-O or CL20
- Can be connected to: DAC400 and DAC500 Series

Accessories

- TMV01 for 35 degree mounting
- RST35/90 Rain protection
- 6170RS Rain protection, stainless steel

Can be connected to

- ARX, RX WEB and RITA systems

Miscellaneous

- Has an integral sabotage contact
- Meets the requirements for IP54
- Read distance 5-7 cm
- Fast reading
- Lockable enclosure
- Illuminated keypad

Article number

• 7585MF	Black	S557 585 084
• 7585MF	White	S557 585 085
• 7585MF	Silver	S557 585 086

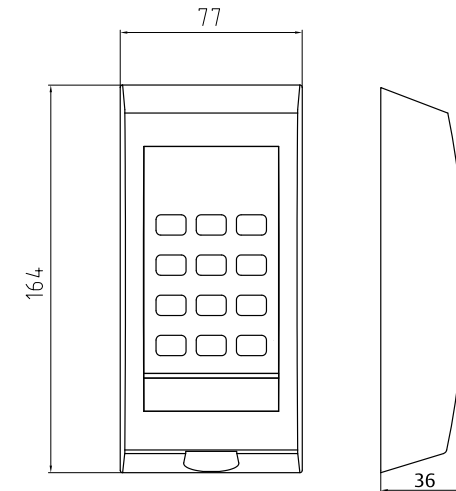
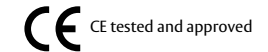

Dimension drawing



5485EM

The 5485EM is a proximity reader with built-in Hi-O technology. The reader is lockable, has an illuminated keypad and clearly marked symbols for easy use.

Hi-O means that the units have a built-in processor and communicate with each other for plug-and-play installation. Hi-O enables intelligent supervision of door behavior, in real time.

The buttons have a distinct tactile response. The 5485EM can also be used as an alarm bypass or code lock.

The 5485EM has clearly-lit symbols such as a green/red man, alarm status, "enter code" and "show code carrier".

The reader meets the requirements for IP54 and is therefore suitable for both indoor and outdoor use. It is used in environments such as garages and offices as well as public environments.



5485EM

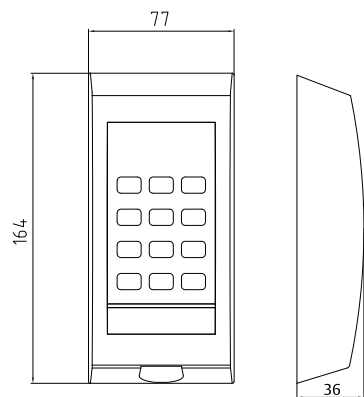

Dimension drawing



HI-O TECHNOLOGY™

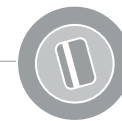

Indicators

- Card reader activated
- Door unlocked
- Door code/code lock function
- Card/tag + PIN code
- Entry blocked
- Indicates alarm status for alarm-authorized card/tag
- Invalid card/tag

Material

- White or black
- Halon/halogen-free
- Cast bottom plate
- Meets the requirements for IP54

Data

- Voltage supply: 12-24 V AC/DC
- Power consumption: 100 mA
- Weight: 0.4 kg
- Temperature range, reader: -25°C to +70°C
- Read technology: EM4102

Accessories

- RST35/90
- 6170RS Rain protection, stainless steel

Can be connected to

- ARX, RX WEB and RiTA systems

Miscellaneous

- Has an integral sabotage contact
- Meets the requirements for IP54
- Read distance 5-10 cm
- Fast reading
- Antenna test position
- Lockable enclosure
- Illuminated keypad

Article number

- 5485EM Black S555 485 084
- 5485EM White S555 485 085
- 5485EM Silver S555 485 086

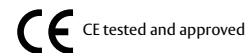



6485EM

The 6485EM is a proximity reader for the EM4102 with a backlit keypad. The buttons have a distinct touch response. The 6485EM can also be used as an alarm bypass facility or code lock.

The 6485EM has clear backlit symbols, such as a green/red man, alarm status, "enter code" and "present card/tag".

The reader meets the requirements for IP54 and is therefore suitable for indoor and outdoor use. It is suitable in environments such as garages and offices or public premises.

Indications

- Card reader activated/ready
- Door unlocked
- Common code/code lock function
- Card/tag + PIN code
- Blocked for access
- Shows alarm status for alarm authorized card/tag
- Invalid card/tag

Material

- Halon/halogene-free
- Cast base plate
- Meets the requirements for IP54

Data

- Feed voltage: 2 V DC
- Power consumption: 100 mA
- Weight: 0.4 kg
- Temperature range reader: -25°C to +70°C
- Reader technology: EM4102



6485EM

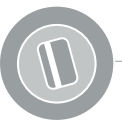

Accessories

- Rain cover 6160RS

Can be connected to

- ARX, RX WEB and RiTA systems

Other

- Built-in tamper switch
- Meets the requirements for IP54
- Read range 5-10 cm
- Fast reading
- Antenna test mode
- Lockable casing
- Backlit keypad

Article number

- Reader 6485EM Black S556 485 084
- Reader 6485EM White S556 485 085
- Reader 6485EM Silver S556 485 086

CE tested and approved

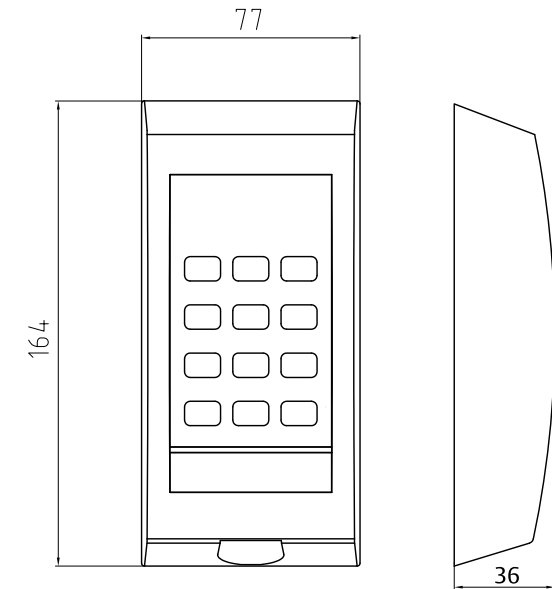

Dimension drawing



6480EM/6481EM

The 6480EM and 6481EM are proximity readers for EM4102 without keypad. The read range is between 5-10 cm.

The readers have a green indication for a valid credential and a red indication for an invalid credential. The green indication also lights up when the door is unlocked.

The readers meet the requirements for IP54 and are therefore suitable for indoor and outdoor use. They can be used in environments such as garages and offices, and also public premises.

The 6481EM has an impact-resistant metal cover, which makes it suitable for environments exposed to the elements.

Indications

- Door unlocked
- Invalid card

Data

- Feed voltage: 12 V DC
- Power consumption: 100 mA
- Reader technology: EM4102

Material 6480EM

- White PC plastic with black sticker
- Halon/halogene-free
- Meets the requirements for IP54

Material 6481EM

- Stainless steel
- Meets the requirements for IP54

Can be connected to

- ARX, RX WEB and RiTA systems

Other

- Built-in tamper switch
- Open and closed assembly
- Fits in standard electrical box
- Read range 5-10 cm
- Antenna test mode
- Green and red indicators

Article number

- Proximity reader 6480EM S556 480 085
- Proximity reader 6481EM S556 481 131 with impact-resistant cover



6480EM



6481EM

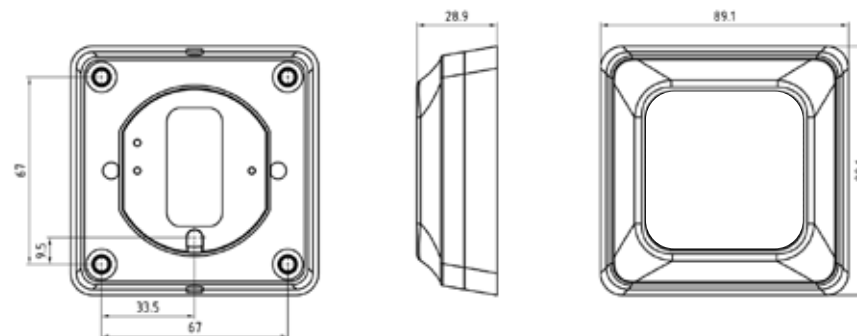

6480EM

Dimension drawing

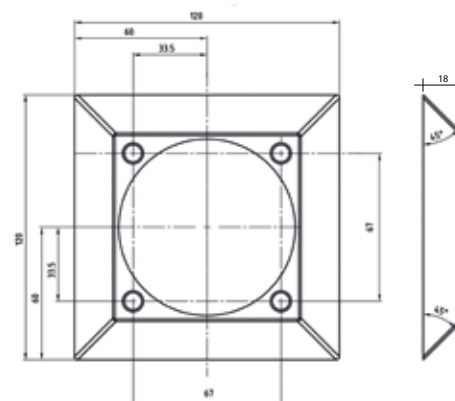

6481EM

Dimension drawing

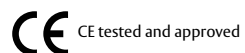

CE tested and approved

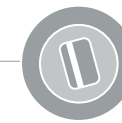

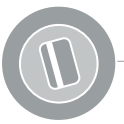

PCR45

The PCR45 is a compact Mifare reader for encrypted sector reading suitable for access control of interior doors in systems using the technology. The PCR45 can be installed stand-alone, in which case it is programmed directly via the keypad, or as an on line system, which facilitates the administration of authorization. The reader easily connects directly to the LCU9016II or LCU9017II and can also be used as a code lock and an alarm bypass facility when it is part of a control unit with at least one DAC430II connected.

The PCR45 is a touch-free reader with a read distance of 4–5 cm and comes in a black, white and silver finish. The reader has backlit symbols, green and red indicators for alarm status, and symbols for “enter code” and “present code carrier”. The keypad is backlit and the buttons are made of durable stainless steel with a distinct touch response.

Both Mifare cards and tags can be used as the code carrier. Both variants are passive and contain no batteries. The tags are practical since they are smooth and can easily be placed on a keyring. Cards can be pure Mifare cards or combination cards with EM4102 and/or magnetic strip. This gives a vast flexibility when a system is converted from another technology to Mifare sector reading, or when you want to use the same card in facilities with different reader technologies. The reader can also be used as a simple serial-number reader.

With a PCR45, you can always grow from the stand-alone reader to an online system with several thousands of doors, without having to replace any reader.



PCR45

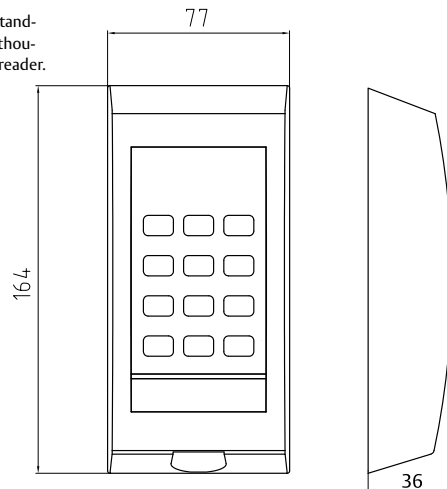

Dimension drawing

Indications

- Card reader activated/ready
- Door unlocked
- Common code/code lock function
- Card + PIN code
- Blocked for access
- Shows alarm status for alarm authorized card
- Invalid card

Material

- PC plastic with black sticker.
- Halone/halogen-free
- Meets the requirements for IP54
- Stainless steel push buttons

Data

- Power supply: 2 – 24 V AC/DC
- Own consumption: 100 mA
- Weight: 0.5 kg
- Temperature range reader: -20° C to +70° C
- Built-in DAC interface: Connects directly to the LCU9016II and LCU9017II

Other

- Built-in tamper switch
- Lockable casing
- Cast base plate

Article number

• PCR45	Black	S556 545 084
• PCR45	White	S556 545 085
• PCR45	Silver	S556 545 086

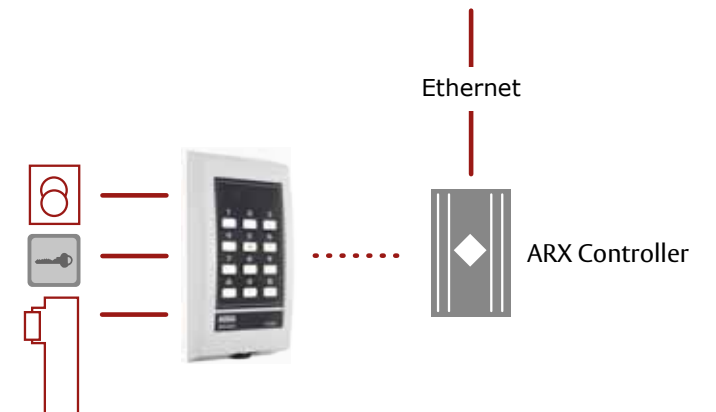
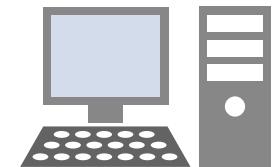



PCR40

The PCR40 is a versatile compact proximity reader that can be connected as a code lock, stand-alone reader or on line reader. This compact, cost-effective proximity reader has a built-in DAC interface for easy installation directly to a controller unit.

The reader is mostly used on interior doors to prevent unauthorized access to premises that don't require high security. Examples of such premises are locker rooms, internal storage and office doors.

The PCR40 has clear backlit symbols, such as a green/red man, alarm status, "enter code" and 2 present card/tag".

The PCR40 can also work as a stand-alone unit, in which case it is programmed directly via the keypad.

The PCR40 can also be used as a code lock.



PCR40

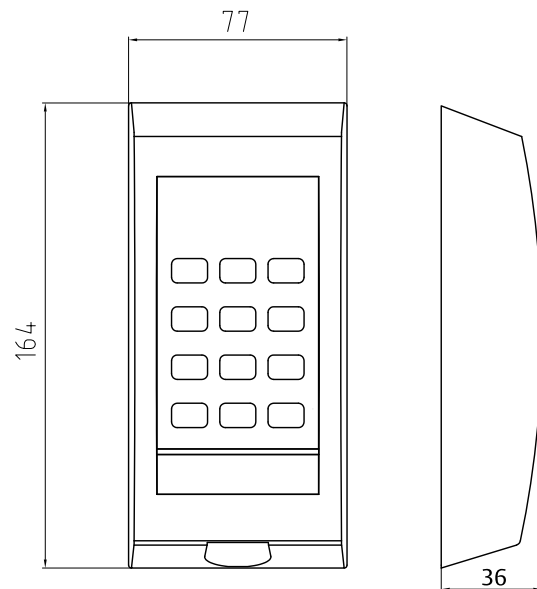

Dimension drawing



Indications

- Card reader activated/ready
- Door unlocked
- Common code/code lock function
- Card + PIN code
- Blocked for access
- Shows alarm status for alarm authorized card
- Invalid card

Data

- Feed voltage: 12-24 V AC/DC
- Output, current or clean contact relay
- Own consumption: 100 mA
- Weight: 1.5 kg
- Temperature range reader: -20°C to +70°C
- Built-in DAC interface: Connects directly to the LCU9016II and LCU9017II
- Reader technology: EM4102

Material

- PC plastic with black sticker
- Halon/halogene-free
- Meets the requirements for IP54
- Stainless steel push buttons
- Cast base plate

Other

- Built-in tamper switch
- Lockable casing

Article number

- PCR40 Black S556 511 084
- PCR40 White S556 511 085
- PCR40 Silver S556 511 086

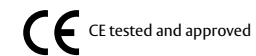



PCI15

The PCI 15 is a compact card input reader for Mifare cards. Both Mifare sector and serial coded cards can be directly read and authorized in the ARX, RX WEB or RiTA access control systems.

The PCI15 also has a keyboard, allowing the user to add or change PINs without having to borrow a keyboard from the operator or receptionist.

The PCI15 has clear lit symbols for easy handling of card input and handling of codes. All communication and feeding is made in the same cable.

The PCI15 handles card input of the Mifare serial number or sector-encoded cards. With sector-encoded cards, the PCI15 is programmed to the correct keys using the system's customer-specific setup card.

The unit connects easily to the RS232 communication port on the computer or a USB port via an adapter.



PCI15

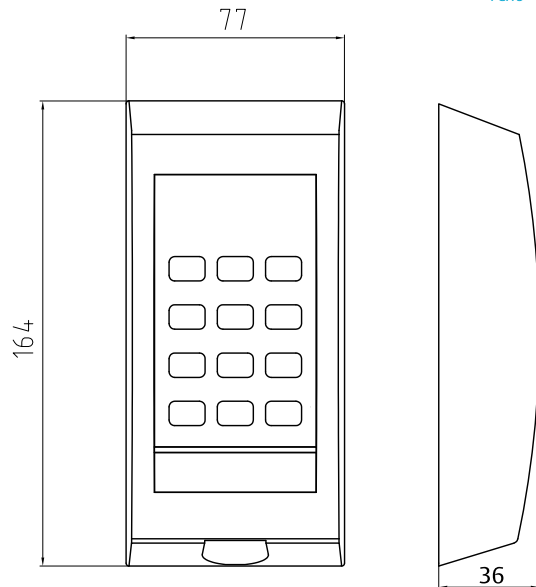

Dimension drawing



Indications

- Cardreader activated/ready
- Read card green/red man
- PIN code
- Blocked for use
- Invalid card

Data

- Power supply: 12-24 V AC/DC
- Own consumption: 100 mA
- Weight: 0.5 kg
- Temperature range reader: -20°C to +70°C
- Built-in RS232 interface: Connects directly to a PC

Material

- PC plastic with black sticker
- Halone/halogen-free
- PBB and PBDE free circuit boards
- Stainless steel push buttons

Other

- Feed and communication in the same cable between PCI15 and the PC client
- Lockable casing
- Cast base plate

Article number

- PCI15 RS232 connection S556 553 085
- PCI15 USB connection S556 553 000



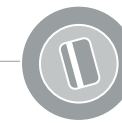

PCI25

PCI25 is a compact Mifare card input reader for Mifare serial or sector technology connected directly to ARX or RX WEB systems.

PCI25 has a keyboard so the user securely and easily can add or alter PIN code codes without using the keyboard of the operator or receptionist.

PCI25 has clear lit symbols for easy handling of card input and handling of codes. All communication and feeding is made in the same cable.

PCI25 handles card input of Mifare serial number or sector encoded cards. At card input reading of sector encoded cards the PCI25 is programmed to the correct keys with the aid of the customer specific setup card belonging to the system.

PCI25 can be configured to program empty Mifare cards at the same time as it is read. The card number becomes the serial number and the customer unique system number locked to the selected sector. This is achieved by loading the PCI25 with the desired number of cards to sector program, in steps of a hundred. This is done with a programming setup card.

The unit is easily connected to the RS232 communication port on the computer or a USB port via an adapter.



PCI25

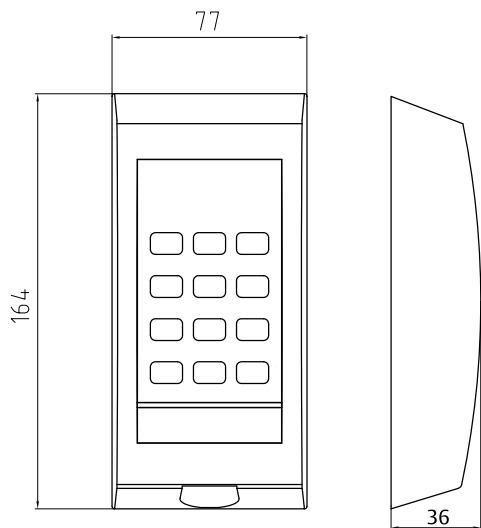

Dimension drawing

Indications

- Cardreader running/ready
- Read card green/red man
- PIN code
- Inhibited for use
- Invalid card

Data

- Power supply: 12-24 V AC/DC
- Own consumption: 100 mA
- Weight: 0,5 kg
- Temperature range reader: -20°C to +70°C
- Built-in RS232 interface: Directly connected to PC

Material

- PC plastic with black sticker
- Halone/Halogen free
- PBB and PBDE free circuit boards
- Stainless push buttons

Other

- Feeding and communication in the same cable between PCI-25 and PC client
- Lockable casing
- Cast base plate

Programming setup card

- PCI25-1 556 554 001 Programming 100 cards
- PCI25-2 556 554 002 Programming 200 cards
- PCI25-3 556 554 003 Programming 300 cards
- PCI25-4 556 554 004 Programming 400 cards
- PCI25-5 556 554 005 Programming 500 cards
- PCI25-10 556 554 010 Programming 1 000 cards
- PCI25-15 556 554 015 Programming 1 500 cards
- PCI25-20 556 554 020 Programming 2 000 cards
- PCI25-25 556 554 025 Programming 2 500 cards

Article number

- PCI25 S556 554 085 RS232 connection
- PCI25 S556 554 000 USB connection
- Mifare Setup card/encryption key S556 585 996

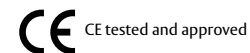



Card input readers for prox cards

PCI10

The PCI10 is a versatile card input reader for prox cards that can be directly connected to ARX, RX WEB or via the enclosed software to all versions of RiTA.

The reader has a keypad, making it safe and easy for card users to enter a new PIN code or change an existing one by themselves.

The PCI10 has clear, lit symbols, a green/red man and "enter code", for ease of use at card input or when changing PIN code. The accompanying software has functions that allow you to change card data.

The PCI10 handles standard Solid format 10 plus 6 digits, i.e. all 40 data bits on the card. You can also change the programming so that the PCI10 delivers a smaller amount of data suited to products from other manufacturers, such as nine digits straight reading or reading method 5-5.

The PCI10 connects easily to the RS232 communication port of the computer, or to a USB port via an adapter.

The PCI10 only has one cable between it and the PC, for both communication and power feed.

Indication

- Card reader activated/ready
- Read card green/red man
- PIN code
- Blocked for use
- Invalid card

Data

- Feed voltage: 12-24 V AC/DC
- Own consumption: 100 mA
- Weight: 0.5 kg
- Temperature range reader: -20°C to +70°C
- Built-in RS232 interface: Connects directly to a PC

Material

- PC plastic with black sticker
- Halon/halogene-free
- Meets the requirements for IP54
- Stainless steel push buttons

Other

- Power feed and communication in the same cable, one cable between PCI10 and PC
- Lockable casing
- Cast base plate

Article number

- PCI10 RS232 S556 550 085
- PCI10 USB S556 550 000



PCI10

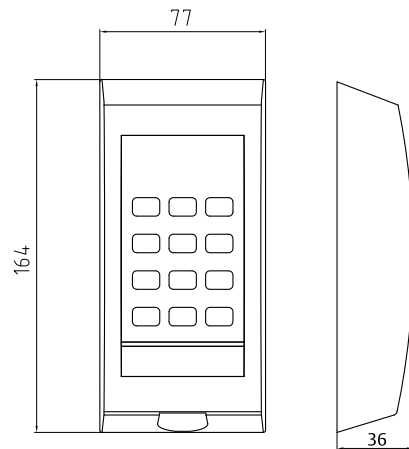

Dimension drawing

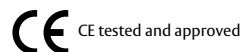

CE tested and approved



Magnetic card readers with keypad

6355M

The 6355M is a magnetic card reader for split installation. It can also be used as an alarm bypass facility and code lock.

The 6355M has a built-in keypad and clear, backlit symbols, such as a green/red man, alarm status, "enter code" and "swipe card".

The buttons have a distinct touch response and the digits are backlit.

The card reader meets the requirements for IP54 and is therefore suitable for indoor and outdoor use.

Indications

- Card reader activated/ready
- Door unlocked
- Common code/code lock function
- Card
- Card + PIN code
- Blocked for access
- Shows alarm status for alarm authorized card
- Invalid card/code

Material

- Cast zinc alloy with white or black powder coating
- Stainless steel push buttons
- Cast base plate

Can be connected to

- ARX, RX WEB or RiTA systems

Accessories

- 6355VS Heater
- Rain cover RST35/90

Other

- Built-in tamper switch
- Reads CR-80 cards on track 2
- Meets the requirements for IP54
- Lockable casing
- Light

Article number

- 6355M Black S556 655 164
- 6355M White S556 655 167

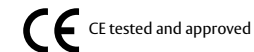

CE tested and approved



6355M

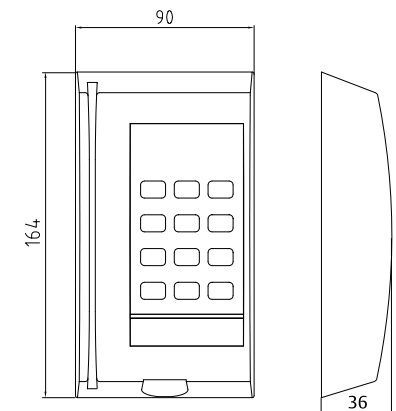

Dimension drawing



6354M

The 6354M is a magnetic card reader without keypad for split installation.

The card reader is suitable to use for access control in indoor environments, such as to storage rooms or offices, where there is no need for the extra security of combining a card and personal PIN code.

The 6354M has clear, lit symbols, such as a green/red man and "swipe card". The card reader meets the requirements for IP54 and is therefore suitable for indoor and outdoor environments.

The 6354M is small, which makes it suitable in many different environments.

Indications

- Card reader activated/ready
- Door unlocked
- Invalid card
- Blocked for access

Material

- Cast zinc alloy with white or black powder coating as standard

Accessories

- Rain cover RST35/90

Other

- Reads CR-80 cards on track 2
- Meets the requirements for IP54

Article number

- 6354M White S556 454 167
- 6354M Black S556 454 164

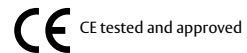

CE tested and approved



6354M

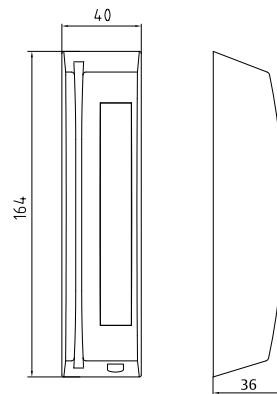

Dimension drawing

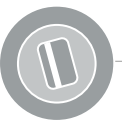

Bracket TMV01

The TMV01 is a wall mount for ASSA readers and code locks. The reader/code lock is mounted at a 35° angle, which is significantly better from an accessibility standpoint than if the reader is mounted completely vertical. The wall mount meets the new accessibility requirements for existing public buildings.

The wall mount is made of stainless steel. It has a mounting plate with channels for cabling from the reader/code lock.

Material

- Stainless steel

Weight

- 0.8 kg

Article number

- TMV01

S556 163 131

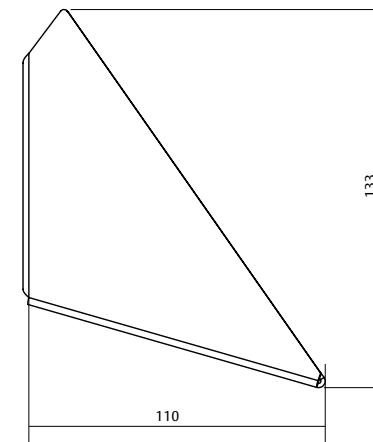

Dimension drawing

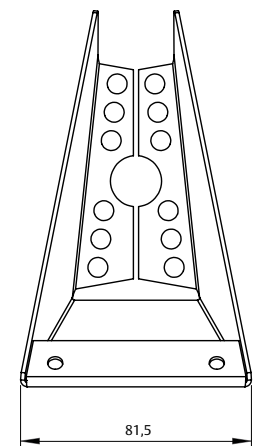



RST35/90

RST35/90 is designed rain cover in plastic with custom mounting holes for ASSA access control reader, for example, 7585MF, PCR45 or code lock 22CL, 25CL and others. It can either be mounted directly on the wall along with a reader or with the reader and mounting angle TMV01.

Material

- Plastic, transparent polycarbonate

Data

- Weight: 0.8 kg

RST35/90 fits the following readers

- 6485EM
- 5485EM
- PCR40
- 7585MF
- PCR45
- 22CL
- 25CL

Article number

- RST35/90 5556 163 035

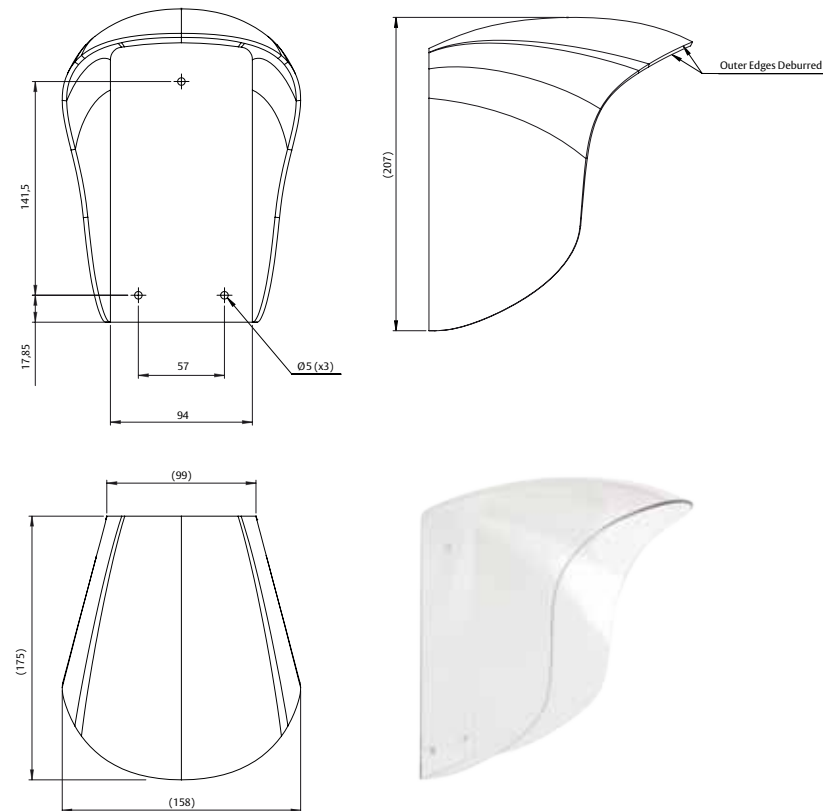

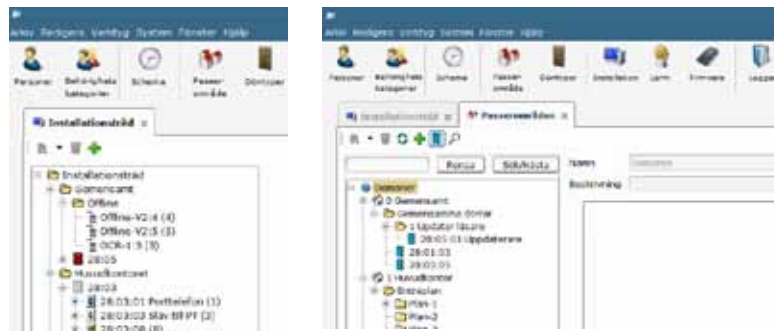

ASSA off line in ARX

The off line function allows an ARX access control system from version 2.4 to handle both on line doors and off line doors in the same system. The off line function means that the off line readers are not directly connected to ARX via cables or network but communicate instead via Mifare cards or tags. An off line reader (door leaf reader or electronic cylinder) contains a clock, schedule, calendar and door ID; while all authorization for doors and validity of cards is programmed into chosen sectors of Mifare cards and tags.

Off line doors are entered into ARX software and then exported to an independent software, PAP, which is installed on a laptop. PAP is used to initiate off line readers using a USB Dongle and radio transmitter.

Validity and authorization for off line readers is transferred via Mifare cards and a UCR that is a combined on line reader (4585MF) and updater/coder (via 9101 single door controller). The schedule is transferred via UCR to off line readers using a Mifare 4k schedule card compiled by ARX.

The following products needs in the installation and administration of off line doors in ARX:

- Software ARX 2.4 or higher
- UCR – Combined on line reader and updater. At least one UCR per installation in order to update and validate authorization in off line doors
- PAP software – Standalone software including USB Dongle for initiation of off line doors
- Off line reader
- Sector Setup card – Programmed in ARX – supplied with UCR
- Schedule Setup card – Programmed in ARX – supplied with UCR

For installation in an existing ARX System, refer to ASSA Technical support web for further specification.

Description

- Menus in ARX for handling off line doors
- Same administration as for on line doors
- Updating of off line authorization and validity performed in conjunction with reading the card in an on line reader (UCR)
- Mifare 1K or 4K (only the first 16 sectors can be used on a 4K card)
- One sector for system setup
- 96 doors/doorgroups/sector
- 6 alarms/sector
- Authorization of up to 1,250 off line doors
- Domain management
- Configuration of optional Mifare sectors
- Higher security by reading Mifare serial numbers in combination with sector reading
- E900S door leaf reader or C900S electronic cylinder
- Authorization via categories or via separate authorization table for personal authorization.
- 16 schedules for authorization, of which 14 can be defined
- A calendar for off line doors – 2 years into the future
- Automatic change of summer time/winter time in off line doors – 2 years into the future
- Battery warnings from off line readers are written to card/tag and then transferred to ARX when a UCR on line door is opened
- Validation time selected/system
- Communication between PAP and ARX software.
- All decisions for opening are taken locally by the respective off line reader

For other specifications, refer to general information about ARX Software.

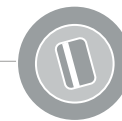

Aperio C900S off line

Aperio C900S is integrated in the ARX system. It is an off line electronic cylinder for Mifare proximity cards and tags. C900S is powered by a CR2 battery and replaces the existing cylinder and cylinder housing. E-cylinders are activated from the outside by a card or tag, allowing the outer part to be turned when authorization is approved.

The existing mechanical lock case can be used, which together with fast, easy assembly provides a cost-effective solution to inner doors in an ARX access control system.

Depending on the choice of lock case, the door can be left unlocked once the e-cylinder has been turned, or be returned to locked status.

C900S communicates with the ARX software via Mifare cards or tags. An on line reader that also functions as an updating function, enters current information about off line authorization at the same time as the door is opened. An easy way to assign authorization to off line equipped doors.

All administration of authorization for the cylinder is performed in the ARX access control system and the same card can be used for both shell protection and interior doors.

LEDs on the reader indicate approved or unapproved entry. Low battery status is indicated well before the battery expires via a flashing red LED. A battery alarm is also transferred as an event to ARX via the access card.

The reader is easy to fit into the door's cylinder recess; there is no need to modify the door or the doorframe. The e-cylinder can also be fitted to cupboards with cylinder locks.

No external power is required since the e-cylinder is powered by a lithium battery. The e-cylinder is supplied fitted to a Scandinavian cylinder housing.

Functions

- The e-cylinder is entered as a door in ARX software and is programmed via PAP software and a schedule card.
- The e-cylinder can be turned as long as it is electronically activated (1–8 seconds) it then automatically returns to locked status.

Communication, card and reader

- Reading technology: Mifare 13.56 MHz with sector reading 1K or 4K.
- Reading distance: 10 mm (depending on the card/tag).

Environment and battery

- Battery type: 1 Lithium CR2 (included)
- Battery life: up to 40,000 cycles
- Relative humidity: up to 85%
- Temperature range: 0 to +60°C
- IP-classification: IP30

Note! The e-cylinder is not suitable for outdoor use.

Reader indications

- Green = Valid authorization
- Red = Invalid authorization
- Yellow flash = Battery level low

Door thickness

- C900S functions with all door thicknesses

Lock case

- Can be used with mechanical lock cases. Please contact your local ASSA ABLOY company

Contents of the package

- C900S e-cylinder fitted to a cylinder housing
- Tool for battery change
- Battery: 1 Lithium CR2
- Installation instructions

Other

- Stainless steel with rubber knob or stainless steel knob
- Size: length 40 mm, Ø35 mm



Aperio E900S off line

Aperio E900S is integrated in the ARX system. It is an off line door leaf reader for Mifare proximity cards and tags. The external door handle is disconnected and is only reconnected when a card has been approved. The internal door handle is always connected. The existing lock case can often be used, which together with fast, easy assembly provides a cost-effective solution to inner doors in an ARX system.

E900S communicates with the ARX software via Mifare cards or tags. An on line reader that also functions as an updating function, enters current information about off line authorization at the same time as the door is opened. E900S does not therefore require any cabling at all.

All administration of authorization for the reader occurs in the ARX access control system and the same card can be used for both shell protection and interior doors.

LEDs on the reader indicate that a card or tag has been read and if it has been approved for entry or not. Low battery status is indicated well before the battery expires via a flashing LED, and a battery alarm is transferred to ARX via the user's access card. The reader is easy to fit into the door's modular recess; there is no need to modify the door or the doorframe. No external power is required since the reader is powered by a lithium battery.

The reader is supplied with a recess for a cylinder and a thumbturn on the inside. The reader is available for various door thicknesses and must be ordered for each individual door environment.

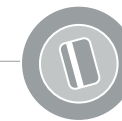

Functions

- The reader is entered as a door in ARX software and is programmed via PAP software with a schedule card and a sector setup card
- The reader automatically returns to locked status after 1–8 seconds

Communication, card and reader

- Reading technology: Mifare 13.56 MHz with sector reading, 1 K or 4K
- Reading distance: 10 mm (depending on the card/tag)

Environment and battery

- Battery type: 1 Lithium CR123A (included)
- Battery life: up to 40,000 cycles
- Relative humidity: up to 85%
- Temperature range: 0 to 60°C
- IP classification: IP52

Note! The reader is not suitable for outdoor use.

Reader indications

- Green = Valid authorization
- Red = Invalid authorization
- Yellow flash = Battery level low

Versions of the reader

- Recess for oval cylinder on the outside and thumbturn on the inside (cylinder not included)
- 45 mm mounting plate included

Door thickness Scandinavian version (specify when ordering)

- 33-42 mm
- 43-52 mm
- 53-62 mm
- 63-72 mm
- 73-82 mm
- 83-92 mm
- Max door thickness 92 mm
- The reader is suitable for both left hung and right hung doors.

Contents of the package

- Outside + inside
- L-shaped handle included
- Battery 1 Lithium CR123A
- Fixing screws for specified door thickness
- Installation instructions
- Description of signals

Lock case

A lock case is not included with the reader. E900S functions on most Scandinavian mechanical lock. Refer to the Project guide for information about functions available with each respective lock case.

Other

- Cover of brushed stainless steel
- U-shaped handle available as accessory

Article number

- Refer to separate price list for reader alternatives and accessories during 2011.

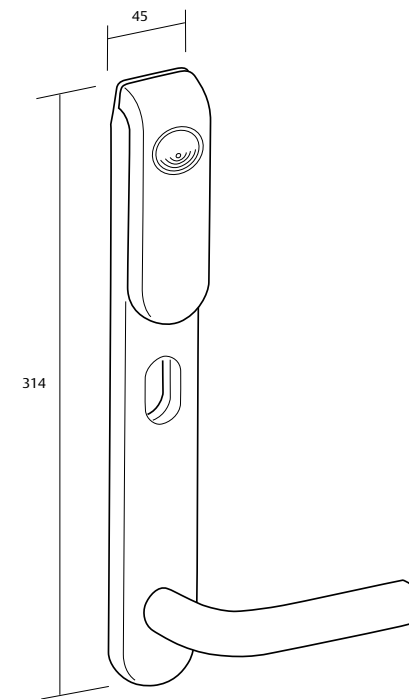
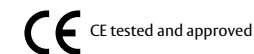



ASSA UCR 01/02

Combined on line reader and updater for off line functions in ARX systems. ASSA UCR is a combined Mifare on line reader and updating unit for off line authorization in ARX systems.

UCR comprises a 4585MF Mifare reader for encrypted sector read/write and a 9101 single-door controller in a shared assembly.

UCR can either be used for just opening a door, or for opening a door and entering changes in the off line authorization on the card. This is decided at system setup. The readers and cards/tags in the installation are coupled together so that only the installation's code carrier can be used in the system. This is achieved by using a customer-unique Setup card that contains the system's encryption keys.

The Setup cards for sector setup, and schedules for off line doors, are programmed via UCR.

In order to use off line functions in ARX, at least one UCR must be included in the ARX installation. UCR can read from and write to standard Mifare cards and tags 1Kb or 4Kb (only the first 16 sectors of a 4Kb card).



ARX uses a base sector to store system and card numbers and at least one sector for authorization to off line doors. 96 off line doors can be stored per sector; up to 1,248 doors can be handled per 1 K card since there is also a sector for storing low battery warnings from off line readers.

For easy operation, the reader has illuminated symbols and sound indications that show the different stages of e.g. approved opening, alarm status, "enter code", or update off line authorization.

UCR is available as UCR01 if only the updater interface for 4585MF is desired, or as UCR02 if control of door automation, etc. is also required. In addition to the interface for the 4585MF reader, UCR02 also has six relays and inputs for e.g. blocking of certain alarms.

UCR is available as UCR01 if only the updater interface for 4585MF is desired, or as UCR02 if control of door automation, etc. is also required. In addition to the interface for the 4585MF reader, UCR02 also has six relays and inputs for e.g. blocking of certain alarms.

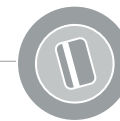

Procedure for opening doors and updating off line authorization:

Card only

- Show card to reader
- The green symbol lights and an acoustic signal sounds, the card is updated (0.5–1 second)
- The door opens when updating is complete

Card and code

- Show the card
- Enter the code; green indicator lights if updating is required
- Show the card to the reader again, until the green symbol lights and an acoustic signal sounds
- The door opens when updating is complete

Specification of readers

- Silver grey or black Polycarbonate cover with a black label
- Halon/Halogen free
- Bottom plate of cast zinc
- Stainless steel buttons
- Supply voltage: 12 V DC
- Current consumption: max 25 mA, via 9101 with 24 V DC supply
- Communication frequency: 13.56 MHz
- Built-in tamper switch
- Fulfils demands for IP54
- Reading distance 3–5 cm
- Lockable encapsulation
- Illuminated keypad and symbols
- Temperature range -30°C to +70°C

Indicators

- Card reader on/read
- Door unlocked (green man)
- Door code/code lock function (yellow button symbol)
- Show alarm status for alarm authorization card/tag
- Invalid card/tag/pin (red man)
- Update card (green man)

Specification single door controller

Indicators

- Power OK
- Link-ACT
- 100M
- FDx
- WDG
- ARX connect
- Over load
- CL ACT
- Relay activated
- Supply voltage: 17–35 V AC or 24–50 V DC.
- PoE (Power over Ethernet) Yes (refer to manual for choice of lock)
- Current consumption: 100mA at 24V DC
- Max load: 12V out 0.7 A
- Flash memory: 32 MB
- RAM memory: 32 MB
- Number of cards: 100,000
- Operational system: Linux
- Ethernet: 10/100 Mbit
- Weight: 200 g
- Volume: 0.0832 m³
- Temperature range: +5°C to +40°C (non-condensing)

Encapsulation

- Impact resistant PC/ABS plastics SIS166653
- Halogen/Halon free

Article number complete UCR

- UCR 01 Black with keypad S559 185 2001
- UCR 01 Silver grey with keypad S559 185 2002
- UCR 02 Black with keypad S559 164 2001
- UCR 02 Silver grey with keypad S559 164 2002

At delivery, a UCR contains a 4585MF reader, an LCU9101 single door controller and 2 setup cards for off line functions. Interface with or without relays determined by type UCR01= only interface, UCR02= Interface and relays, and 2 setup cards for off line functions.

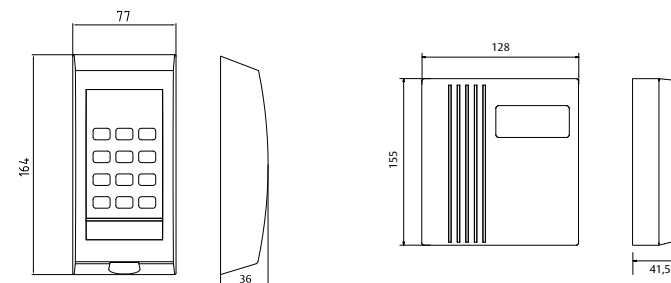

Dimension drawing



ASSA OCR55

ASSA OCR55 is an off line Mifare reader with built-in Hi-O technology. It reads encrypted information about authorities programmed in selected sectors of the Mifare card via the offline feature in ARX and UCR update readers.

Off line means that the OCR55 has no direct contact with ARX software and can therefore be placed in areas without access to a network. OCR55 is powered by an external, local power supply and can control Hi-O locks and conventional electric locks. Choice of electric lock depends on the security required for each door.

The OCR55 is deployed using a card and keypad (Set up card off line containing the system's unique encryption keys), Schedule set up card and sector set up card, programmed using ARX software and UCR update readers.

Entry for door position and opener button is available. The OCR55 has a built-in clock with a calendar. It allows for 16 different schedules and can handle cards, card + code and 8 door codes. It can be set to unlocked according to a schedule, or manually by showing the card to the reader two times. The function is authority-controlled in ARX.

The OCR55 has time functions that make it possible to choose how long the electric locks will be unlocked after presenting a card or pressing the opener button.

The OCR55 can be excluded from the system's standard validation time, by activating an offset time in the respective OCR55 of 1-99 days. The offset time makes it possible to obtain a longer validation time for the selected OCR and is used if a specific door is located far from the updating readers.



OCR55

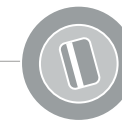

Indicators

- Card reader on/ready
- Door unlocked (schedule-driven)
- 8 door codes/code lock function (schedule-driven)
- Card/tag + PIN code code (schedule-driven)
- Invalid card/tag
- Buzzer (schedule-driven, 10-255 sec)

Material

- Silver or black Polycarbonate
- Halon/Halogen-free
- Bottom plate of cast zinc

Data

- Supply voltage: 17-28 V DC and 17V AC
- Power consumption: 50mA vid 24V DC
- Weight: 0.45 kg
- Temperature range, readers: -25°C to +70°C
- Reader technology: Mifare sector

Other

- Meets IP54 requirements
- Reader distance 5-7 cm
- Lockable encapsulation
- Illuminated keypad

The OCR55 has built-in 12V voltage output to be able to supply the 12V electric lock and the Hi-O bus. The output can be loaded with 700mA (0.7A).

The 24V electric lock can be used when the OCR55 powered by at least 24V.

The OCR55 can handle conventional electric locks that are connected via relay and Hi-O electric strike, Hi-O electric handle lock, Hi-O motor lock, as well as Hi-O opener button and Hi-O automatic door. Read-out scanner is not supported.

Article number

- ARX offline OCR55 Black S556 850 084
- ARX offline OCR55 Silver S556 850 086

The OCR55 requires a minimum of version 2.6 of ARX.

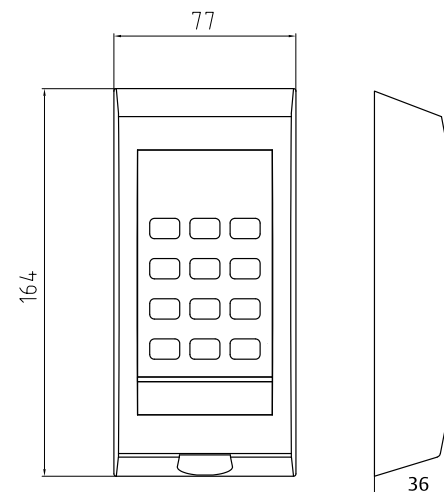
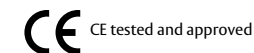

Dimension drawing



Apero PAP Tool

Software for the deployment of off line readers in ARX systems. PAP (Programming Application) is used for deploying off line readers in ARX. PAP is installed on a laptop and communicates with ARX via network or XML file, and wirelessly with off line readers via a USB Radio Dongle.

The door data is then transferred from ARX to PAP and then further to the off line doors. This is done once when the doors are deployed, i.e. are initiated with the encryption keys and the system setup that has been specified for each door. After which PAP is only used in cases where one wishes to make alterations to the door ID.

All information concerning authorization and validity time is programmed on the user's Mifare access card and the information therefore does not need to be transferred to the door.

PAP is also used for reading out logs from off line readers. These logs can be saved to a file or printed out. The most recent 200 logs are saved in each off line reader.

Description

PAP is installed on a laptop. You use PAP to scan for the off line reader that you wish to initiate. The radio Dongle searches for the reader in question and connects up to it. Clicking on "configure door" sends the door data to the reader. Once a door has been initiated, it disappears from the door list in PAP.

Any schedule for authorization is transferred to off line readers with a schedule setup card, in which case PAP is not required.

By clicking on "transfer data" in PAP, information describing which off line doors have been initiated is sent back to ARX. ARX then has a menu: off line door status that shows which off line doors have been initiated correctly.

Article number

PAP software complete.



270NMW

The 270NMW is a long range reader for access systems. The Reader has a built-in antenna for fast and easy installation.

The RFID credential is automatically identified at distances up to 10 meters with a vehicle speed at of up to 200 km/h.

Thanks to the long read distance, the reader can be installed in a sheltered environment to prevent damage. Reading is made with a directional beam, which gives an exact determination of the detection area.

The reader works at a preset frequency, which allows several readers to work near each other without interference.

The 270NMW is designed for outdoor use and works reliably rough environmental conditions. It can handle both rain and snow.

Data

- Working frequency: 2.400 – 2.482 GHz
- Size: 310 x 250 x 100 mm
- Weight: 5.0 kg
- Casing classification: IP65
- Detection range: Up to 10 m
- Distance control: Acoustic with built-in buzzer
- Working temperature: -30°C to +55°C
- Vehicle speed: Up to 200 km/h within the distance range
- Voltage: 230 V AC +10%, 100 mA, 50-60 Hz/22-30 V DC, max 1A
- Power consumption: < 25 VA (from AC), < 20 W (from DC)
- Frequency setting: 138 channels; channel separation 600 kHz to avoid interruptions, used when readers are installed near each other
- Polarization: Circular (LHC)
- Input: 1 dry contact or TTL
- Relay output: 1 Relay output (NO, gem., NC), 24 V DC, 2 A; 120 V AC, 1 A
- Output: Omron ISO 7811/2 CL/Data (ASSA/Solid Prox format)
- Connection: RS232
- Encrypted air interface: NEDAP specific encryption standard



270NMW

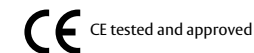

CE tested and approved

Material

- Stainless steel (AISI304) with ABS cover

Assembly

- Assembly kit for wall mounting included
- Attachment for pole mounting as accessory

Approvals

- EMC: European Directive for EMC 89/336/EEC, ETS0908 Security: EN 60950
- Regulations: FCC part 15.245 and ETS 300 440

Article number

- Long-range reader 270NMW S552 090 000
- Pole attachment for 270NMW S552 095 999
- Interface 6390IF S583 388 085



Credentials for long range reader 270NMW

Many types of credentials are compatible with long range reader 270NMW depending on your need for functions and security level. They all have a read range of between 5-10 meters and vary in design depending on area of use.

For higher security and service level in authorization of vehicle passage, the reader has boosters that transmit the driver's regular access card ID to the reader. This way, the driver does not need to stop the vehicle for personal identification.

For even higher security levels, there are boosters that transmit both the driver's personal ID and the vehicle ID to the reader for double checking before access.

CE CE tested and approved



270NBE



270NBS – Vehicle tag with button

270NB – Vehicle tag without button



270NBE – Vehicle booster for Prox card

270NCBE – Vehicle booster combi for Prox card



270NBE

- Impact and water-resistant vehicle RFID tag for exterior mounting on vehicle
- Delivered pre-programmed
- Designed for read range of up to 10 m
- Dimensions: 170 x 60 x 20 mm
- Weight: 112 g
- Article number: S552 089 999



270NBE

270NB – Vehicle tag without button

- Vehicle tag for read range of up to 10 m
- Delivered pre-programmed
- The tag has a suction cup for inside mounting on the windscreen of the vehicle
- Dimensions: 76 mm in diameter
- Weight: 55 g
- Article number: S552 091 999



270NB – Vehicle tag without button

270NBS – Vehicle tag with button

- Vehicle tag for reading up to 10 m. The tag has a button which transmits the card number for five seconds. Delivered pre-programmed. The tag has a suction cup for mounting on the inside of the of the windshield
- Dimensions: 76 mm in diameter
- Weight: 55 g
- Article number: S552 092 999



270NBS – Vehicle tag with button

270NBE – Vehicle booster for Prox card

- Vehicle tag that transmits the user's personal ID. When users place their personal ID card in the booster and press the button, the card ID is transmitted for five seconds. The booster has a suction cup for mounting on the inside of the windshield
- Designed for reading at up to 10 m
- Article number: S552 099 999



270NBE – Vehicle booster for Prox card

270NCBE – Vehicle booster combi for Prox card

- Combi booster transmits both the personal ID of the user and the vehicle ID. When users place their personal ID card in the booster and press the button, both IDs are transmitted for five seconds. The booster has a suction cup for mounting on the inside of the windshield
- Designed for read range of up to 10 m
- Article number: S552 098 999



270NCBE – Vehicle booster combi for Prox card



RCE16

The RCE16 is a relay unit designed for controller units LCU9016II and LCU9017II.

For the ARX system, the RCE16 is used together with the ARX Elevator function, which controls elevators or mail boxes.

It is also useful for locked showcases in stores, mail-boxes in apartment buildings, in office premises and for locker rooms in places like public pools.

The RCE16 consists of 16 LED-indicated relays with change-over contacts between NO/NC that can be selected with jumper links.

It has built-in tamper contacts and four diodes indicating the unit's status.

Casing

- Impact-resistant ABS plastic SIS 166653
- Halon/halogene-free

Data

- Feed voltage: 12 -24 V AC/DC
- Own consumption (24 V DC): 11mA
- Relay max load: 1 A (24 V)
- Working temperature: +5°C to +40°C
- Power consumption when all relays in the RCE16 are used: 170 mA with 24 V
300 mA with 12 V

Other

- Meets the requirements for IP54

CE CE tested and approved

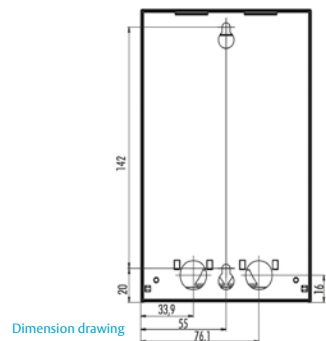

Dimension drawing



RCE16

Indications

- TX – Green indication (Transmits data to the control unit)
- RX – Orange indication (Receives data from the control unit)
- PWR – Yellow indication (voltage)
- ALIVE – Blue indication (working)

Article number

- RCE16 S554 340 085

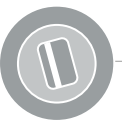
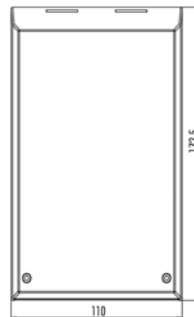
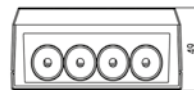

Relay Board 9016RC

Relay board 9016RC has four relay outputs and two inputs. Three relay outputs are software controlled and the fourth relay is used to control the CPU.

Relay 1 and 2 with a jumper pin selectable for NO or NC and Relay 3 is a changeover relay (NO, C, NC).

Input 1 can be used for forced locking or unlocking (central unlocking of doors when fire alarms). The relay outputs 1-3 can be programmed to follow a schedule or event such as threat code, door forced, door open too long, motor lock error, sabotage or communication failures, etc.

See ARX manual for detailed information.

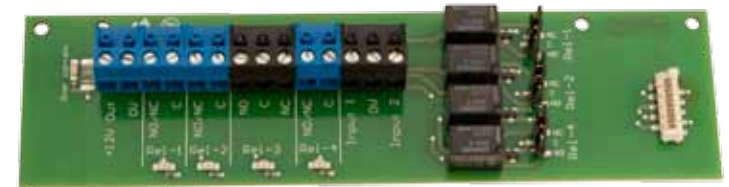



PSS60 and ST60S

The PSS60 and ST60S are suitable as power sources for ASSA access system products.

The PSS60 is a protective transformer that can be mounted on a DIN rail.

The ST60S is another protective transformer with a thermally protected ring core.

Protective transformer PSS60

- Maximum input power: 240 V AC
- Nominal output power: 26 V AC (at 0.2 A load and 230 V in power)
- Maximum load: 2.5 A
- Weight: 1 300 gr
- Dimensions (H x W x D): 120 x 72 x 72 mm
- Temperature range: 0°C to +50°C
- Casing: Cover in white ABS plastic

Protective transformer ST60S

- Maximum input power: 240 V AC
- Nominal output power: 26.1 V AC (at 0.5A load and 230 V in power)
- Maximum load: 2.5 A
- Thermally protected
- Weight: 837 gr
- Dimensions (H x W x D): 114 x 79 x 63 mm
- Ambient temperature: +50°C
- Casing: Polycarbonate and ABS

Article number

- ST60S S511 006 087
- PSS60 S511 005 087

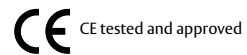

PSS60



ST60S



TKN40

The TKN40 is a touch-free exit button for easy unlocking of the door from the inside. The touch-free function makes it very suitable in sterile environments where you want to avoid physical contact. All you have to do is hold your hand in front of the exit button, at a distance of up to one centimeter, to unlock the door.

The exit button is easy to connect to the door environment via the DAC.

Indications

- Blue LED

Material

- White PC plastic with black sticker
- Halone/halogen-free
- Fits in standard electrical box

Data

- Feed voltage: 12-24 V DC
- Power consumption: 50 mA
- Touch distance: 1 cm

Article number

- TKN40 White S514 000 085 E58 700 47

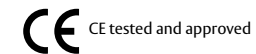

TKN40

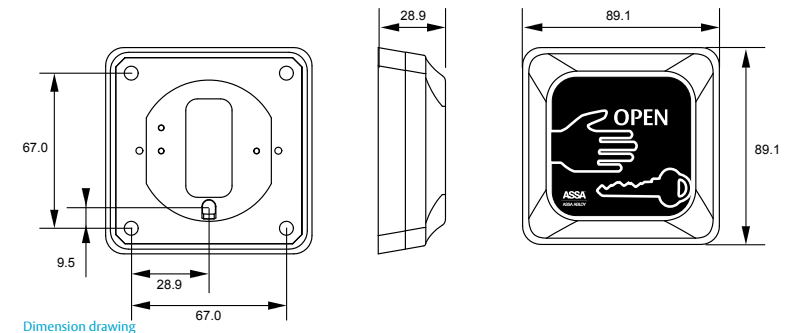
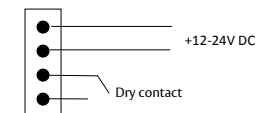

Dimension drawing



TKN50

The TKN50 is a touch-free exit button for easy unlocking of the door from the inside. The touch-free function makes it very suitable in sterile environments where you want to avoid physical contact. All you have to do is hold your hand in front of the exit button, at a distance of up to one centimeter, to unlock the door.

The TKN50 is a Hi-O unit. Hi-O means that the units have a built-in processor and communicate with each other for plug-and-play installation. Hi-O enables intelligent supervision of door behavior, in real time.

Indications

- Blue LED

Material

- White PC plastic with black sticker
- Halone/halogen-free
- Fits in standard electrical box

Data

- Feed voltage: 12-24 V DC
- Power consumption: 50 mA
- Touch distance: 1 cm

Article number

- TKN50 White S515 000 085 E58 761 62



CE tested and approved



TKN50



HI-O TECHNOLOGY™

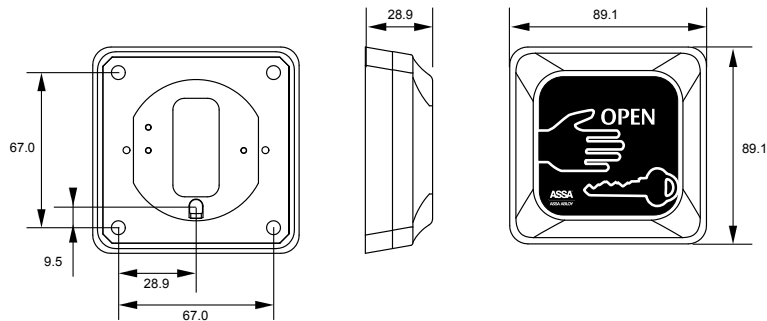

Dimension drawing



Credentials

Various types of credentials, such as cards or tags, are used to control an access control system. In this section we present some of the products contained in the standard range. You can also order special features, such as a custom design, Photo ID or programming of the magnetic strip or Mifare card if you want to combine an access control system with other applications. Our product range also includes a variety of card clips for safer handling of cards and tags.



Touch-free Mifare card with magnetic strip

Proximity cards and tags

- Passive touch-free tag EM4102, in the keychain format, black with ASSA logo
- Passive touch-free card EM4012 with magnetic strip, white or black with ASSA logo, CR80 format. No information on the magnetic strip
- Passive touch-free tag EM4102, adhesive
- Touch-free Mifare card with magnetic strip, white or black with ASSA logo, CR80 format. No information on the magnetic strip
- Touch-free Mifare combo card with EM4102 and magnetic strip. White or black with ASSA logo, CR80 format. No information on the magnetic strip
- Mifare tag, black with ASSA logo



Touch-free tag

Magnetic cards

- Magnetic card, CR80, HiCo, no information on the magnetic strip, black with ASSA logo
- Magnetic card, CR80, HiCo, no information on the magnetic strip, white



Magnetic card ASSA



CODE LOCKS

ASSA Code Locks are a series of compact locks that are easy to install and let you control access without complicated key management, to facilities that do not require maximum security. Examples of such premises include changing rooms, internal storage and entrances to apartment buildings.

All ASSA Code Locks can be used both indoors and outdoors and meets the requirements for IP54.





Compact code lock with AUX

22CL

The 22CL is a compact code lock with simple installation. The code lock makes it possible to control access to facilities that do not require high security. Examples of such facilities are locker rooms, internal storage and apartment building entrances.

The code lock can be used both indoors and outdoors and meets IP54 requirements. The buttons have a distinct touch response and the digits are illuminated in blue.

A door with this code lock locks immediately when the door is closed, if an electric strike with a door monitor switch is connected. This feature is made possible by the built-in termination function to the door relay output.

The 22CL also has an AUX relay that can be selected to control an additional door with a custom code or with a common code for both doors.

The function is easily selected when programming codes, whether the code should belong to the door output, the AUX output or if both outputs will be affected by the chosen code.

The AUX output on the 22CL can also be selected to work varying from a specific code. This toggle mode to the AUX relay can be used to set the door in an unlocked position, using a selected code, until the code is re-entered.

The 22CL also has the option of allowing the AUX output be selected to work as a duress alarm output. In this mode, the AUX relay is activated when raising the first digit of the code and the usual door relay is activated at the same time that an alarm can be sent, for example via an alarm transmitter.

With the 22CL, you can choose between a 4-digit or 6-digit access code. The 22CL is easy to program from the keypad. The code memory is completely independent of voltage, enabling power supply via timer.



22CL

Compact code lock with AUX



Indicators

- Programming mode
- Programming accepted
- Programming not accepted
- Erroneous code block
- Unlocked
- "Keystroke"

Data

- Supply voltage: 12-24 VAC/DC
- Maximum current consumption: 22CL = 85 mA
- Output, voltage or free relay closure: max 24 V/1A

Material

- Encapsulation in polycarbonate
- Stainless steel pushbuttons
- Cast base plate and cover

Accessories

- Rain cover RST35/90
- Rain cover 6170RS

Functions

- Seven 4-digit or 6-digit codes
- Codes 5 and 6 can jointly be blocked using a timer
- Code 7 can be time-limited from 1 to 9 days
- AUX-relay output
- One or two doors (Selectable via DIP)
- Panic function (Selectable via DIP)
- Alternating relay on/off via code
- Erroneous code block (Selectable via DIP)
- Auto termination of opening time
- Meets IP54 requirements
- Lockable encapsulation
- Illuminated keypad in blue (On/Off via DIP)

Article number

- 22CL Silver grey 5532 222 086
- 22CL Black 5532 222 084

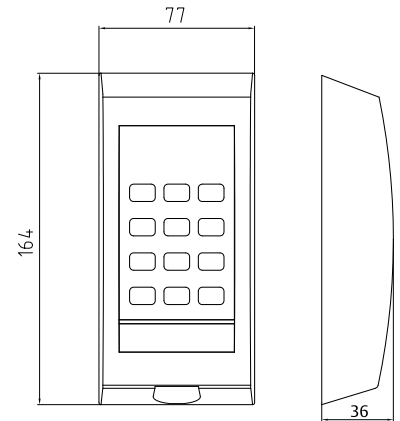

Measurement in mm, not proportional

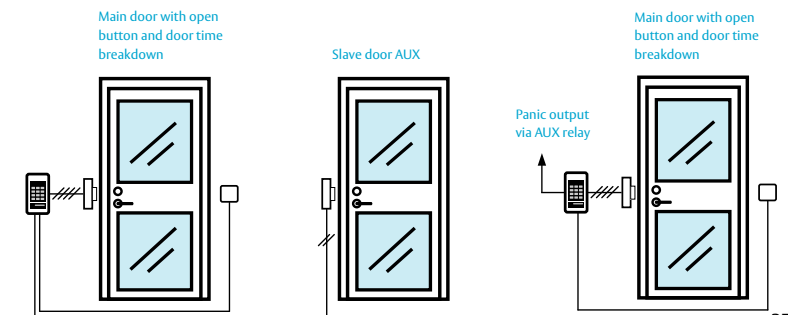
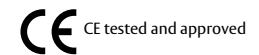



Compact Hi-O™ code lock

25CL

The 25CL is a compact Hi-O code lock with encrypted communication between the code lock and the electric lock. Because the 25CL works with encrypted Hi-O bus technology, code locks directly control electric strikes, electronic locks and motor locks. Hi-O-based automatic doors can also be connected.

The 25CL has no relays, which means that the risk of manipulation is drastically lower than in traditional code locks with relays.

The 25CL makes it possible to control access to facilities that want or require higher security than a traditional code lock can offer. Examples of such facilities are retail warehouses, personnel entrances to shops, or entrances to apartment buildings.

The 25CL is easy to program from the keypad. The code memory is completely independent of voltage.

The 25CL can be programmed with up to 10 different codes, including 5 codes that can be blocked by an external timer, divided into blocks of three and two codes.

The tenth code can be programmed to be canceled after 1–30 days, which means that it can be used to let in e.g. tradespeople for a limited period of time.

The 25CL can handle optional code lengths from 4 to 9 digits.

The code lock can be used both indoors and outdoors and complies with IP54 requirements. The buttons have a distinct touch response and the digits are backlit.



25CL



HI-O TECHNOLOGY™

Compact Hi-O™ code lock



Data

- Supply voltage: 17–28 V DC (12 V DC *) 17 AC
* If the CL25 is fed with 12 V all units must be connected to pins 1 and 2.
- Maximum power consumption: 12 V Max 80mA, 24 V Max 50mA
- Hi-O voltage output: 12 V DC, max 500mA
- Working temperature: -25 up to +70°C
- Recommended cable: EKKX 2x2x0,2
- Hi-O cable length: Total max 50m, branch line max 10 m
- Dimensions: H: 163 mm, W: 76 mm, D: 35 mm
- Number of door codes: 10
- Optional code length: 4 to 9 digits

Material

- Cast zinc cover, black or silver gray
- Stainless steel pushbuttons
- Bottom plate of cast zinc

Functions

- 10 codes, can be selected per 25CL to be 4 to 9 digits long
- Codes 1–4 No blocking
- Codes 5–7 Blocking entry A
- Codes 8–9 Blocking entry B
- Code 10 Time-limited code, 1–30 days
- Code lock 25CL is blocked when tamper switch is triggered (Selectable)
- Erroneous code block (Selectable)
- Code for Toggle function, unlocks and locks every other time the toggle code is used
- Erroneous code block (Selectable via DIP)
- Auto termination of opening time
- Meets IP54 requirements
- Lockable encapsulation
- Backlit keypad (Selectable On/Off)

Indicators

- Valid code entered
- Programming mode
- Programming accepted
- Programming not accepted
- Code blocked via entry A or B
- Blocked by triggered tamper blocking surveillance
- Erroneous code block
- Unlocked
- “Keystroke”

Article number

- 25CL Black S532 225 084
- 25CL Silver gray S532 225 086

Accessories

- Hi-O electric strike 585
- Hi-O Motor Lock 810C/811C
- Hi-O Electronic Lock EL587
- Hi-O Opener button TKN50
- RST35/90 Rain Shelter
- TMV01 Accessibility installation angle, low installation for handicap accessibility

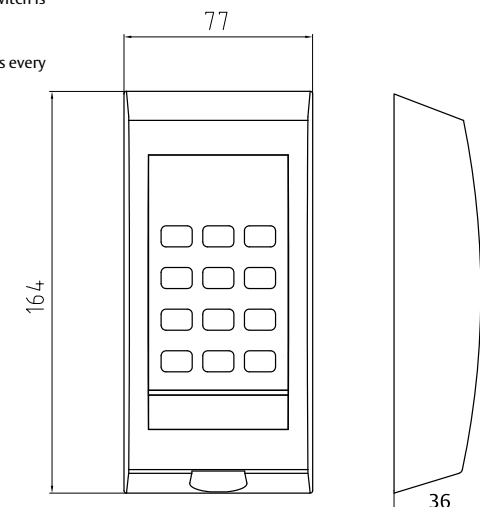
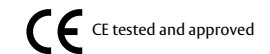

Measurement in mm, not proportional

**240IR**

The 240IR is different from the other code locks in that the postal delivery code is transmitted with a "remote control". A great concern for building owners and residents is that mail codes often end up in the wrong hands. The postal or newspaper carrier unlocks the door with their remote control, sending an IR signal to the receiver on the code lock.

Residents enter as usual by entering their own codes. In this way only authorized people have access to the building, which ensures safety.

The building owner decides which IR channels will have access to the building. The IR code is changed automatically with the IR transmitter, with no administration from the building owner. The postal delivery staff do not know the current code.

With this code lock and an electric strike plate with a door monitor switch, the door locks instantly on closing, due to the built-in termination function.



240IR

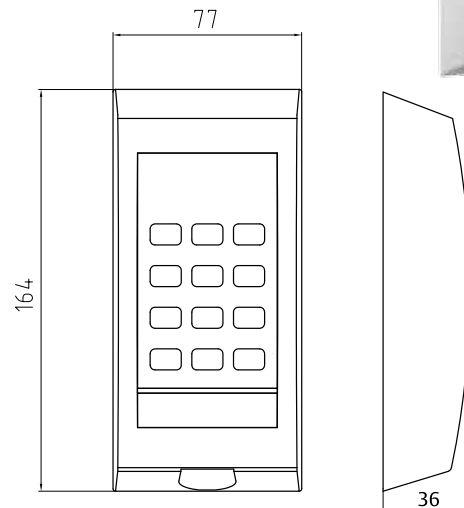

Measurement in mm,
not proportional

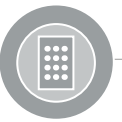
**Indications**

- Programming mode
- Programming accepted
- Programming not accepted
- Erroneous code block
- Unlocked
- "Key press" indication

Material

- Cast zinc alloy with white or black powder coating as standard
- Stainless steel push buttons
- Cast base plate

Data

- Feed voltage: 12-24 V AC/DC
- Max current: 240IR = 110 mA
- Output, free relay closure: max 24 V/1A

Accessories

- Rain cover RST35/90
- Rain cover 6170RS

Other

- Seven IR channels
- Two 4 or 6-digit codes
- Code 5 and 6 can be jointly blocked via e.g. a time switch
- Erroneous code block
- Automatic termination of opening time
- Fulfill the requirements for IP54
- Lockable casing
- Backlit keypad

Article number

- 240IR White S532 300 167
- 240IR Black S532 300 164
- IR Test transmitter S531 250 184
- 120IR IR receiver for extension of existing code lock S531 200 185



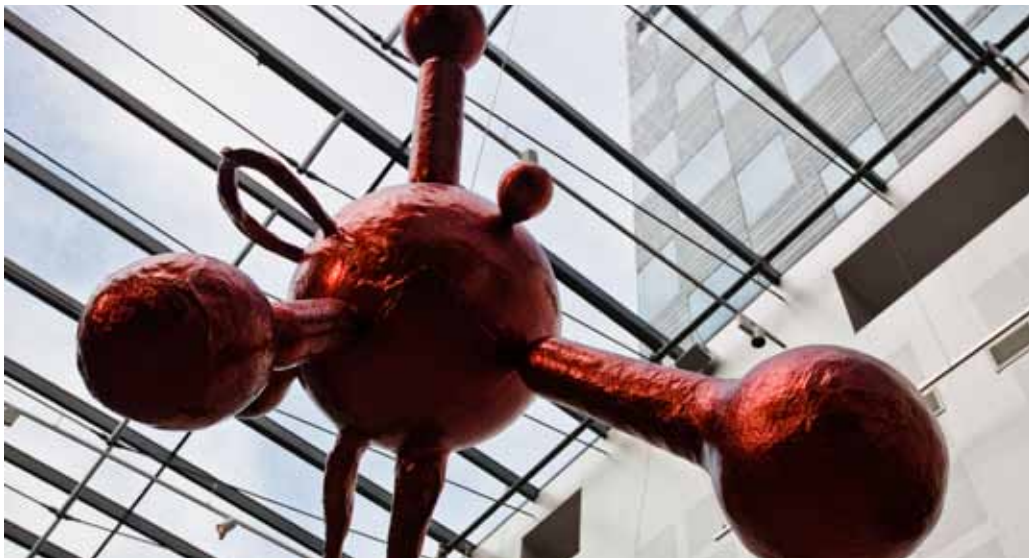

DOOR CONTROL



Safe and secure door closer

The ASSA ABLOY Group has more than 90 year's experience of producing door closers. Our products are used to close doors all over the world and meet both Swedish and international standards ISO 9001, EN and ANSI.

ASSA Door Control allows many possibilities. It is not only about controlled door closing but also about convenience, comfort, security and safety.





ASSA ABLOY Door closer

ASSA ABLOY D10, D15, DC200, DC300, DC500 and DC700 have been developed to meet the requirements of EN 1154, 1155 and 1158.

Features

- Door closer body is made of cast aluminium
- Removable body cover in several colours: silver, white, black and brown. Finishes available on request: NCS, RAL, stainless
- High efficiency
- Adjustable closing force
- Available with standard arm and hold-open arm
- Easily adjustable arm height 14 mm and narrow fixing of door closer body make installation easy
- Back check and delayed closing
- Same accessories for DC200, DC300, DC500 and DC700

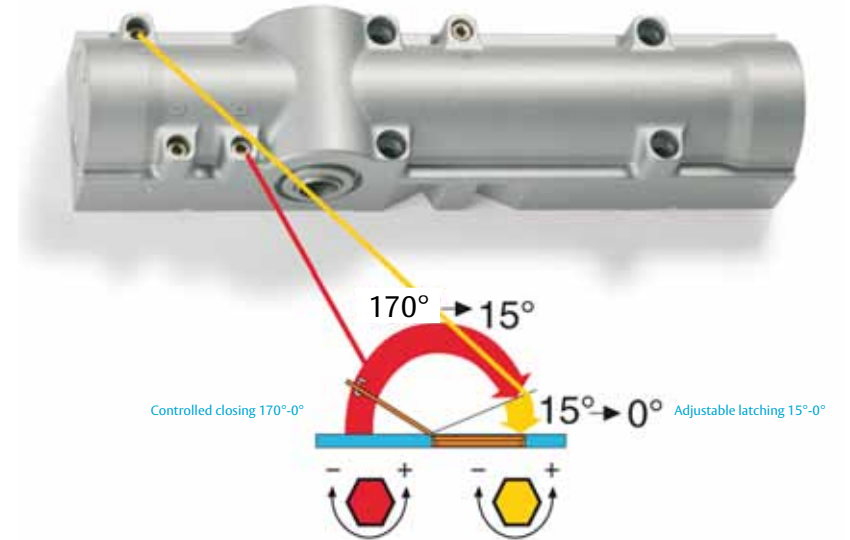

Adjusting latching and closing speed, delayed closing and back check.

Closing force CEN			
Door closer size	Closing force (in Nm at 2°)	Door width (mm max.)	Door weight (kg)
1	9	750	20
2	13	850	40
3	18	950	60
4	26	1100	80
5	37	1250	100
6	54	1400	120
7	87	1600	160

Door control

Door control



Door closer ASSA ABLOY D10



ASSA ABLOY D10

ASSA ABLOY D10

Application

ASSA ABLOY D10 is suitable for light interior doors where safe and controlled closing is required. The closer body is made from high quality die cast aluminium. D10 is a compression spring door closer (Rack and Pinion).

Features

- Adjustable spring force 2-3 EN
- Can be installed on door leaf or frame
- Maximum door width 950 mm
- Adjustable valve-controlled closing and latching force
- Colour: silver
- Dimensions: length 210 mm, height 56 mm, width 42 mm
- EN 1154

Adjusting of closing and latching force

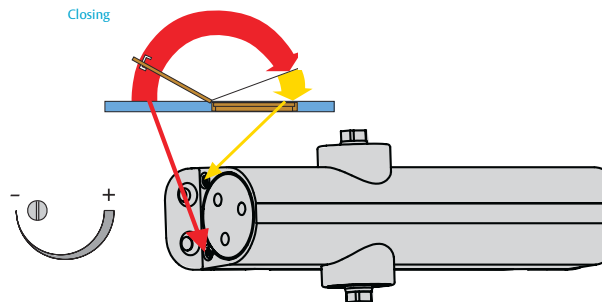

Door closer ASSA ABLOY D10

Installation

Opening side

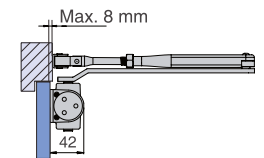
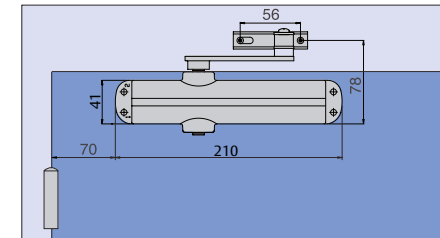

Closing side

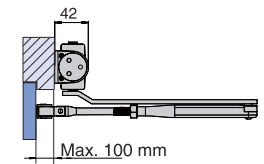
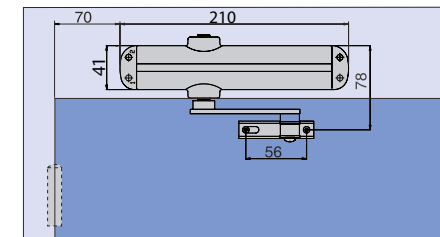

Dimensions

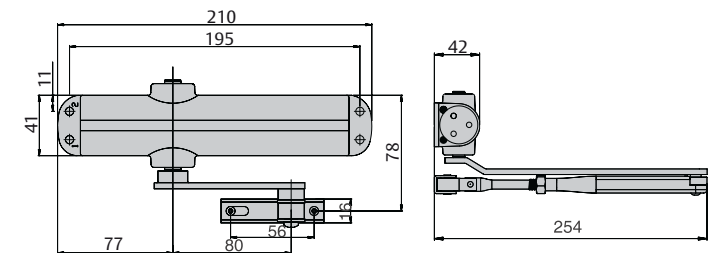



Door closer ASSA ABLOY DC200



ASSA ABLOY DC200

ASSA ABLOY DC200

Application

The ASSA DC200-series suits all types of exterior, interior and fire doors that require secure and controlled closing.

Function

Door closer body is made of cast aluminium. DC200 is a compression spring door closer with high quality hydraulic oil and temperature compensating valves.

Features

- Adjustable spring force 2-4 EN
- Max. door width 1100 mm
- Can be installed on door leaf or frame
- Closing and latching speed is adjustable with valves
- Easy mounting with adjustable arm
- Adjustable arm height 14 mm
- Pressure relief valves for protection of the door closer
- Temperature compensating valves
- Dimensions: length 223 mm, height 60 mm, depth 47 mm
- Cover in several colors: silver, white, black and brown. Finishes available on request: NCS and RAL
- EN 1154
- CE-certified

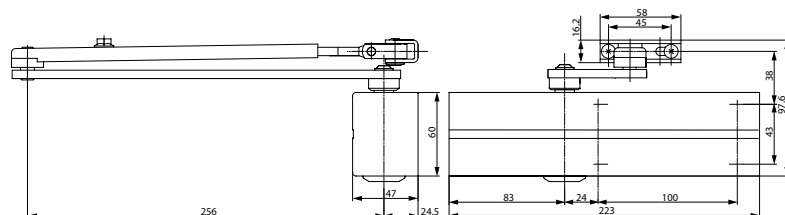

Door closer ASSA ABLOY DC200

ASSA ABLOY DC200

Door closer body

DC200 size 2-4 EN adjustable.
Max. door width 1100 mm.
Latching and closing speed adjustable with valves.
Adjustable arm height 14 mm.



Door closer body

Accessories

Standard arm

L190 frame depth 0-100 mm
L199 frame depth 0-100 mm non detachable
L198 frame depth 100-200 mm
D3014 frame depth 0-70 mm



L190/L199/L198



DC30014



L191

Hold open arm

L191 frame depth 0-70 mm.
Max. hold-open angle 150°.
Blocking function can be switched on and off.
(Not for fire doors).

Mounting plate

A120 can be used for a narrow frame or rebated door leaf. Suits Dorma and Geze.



A120

Angle mounting plate

A154 for mounting on closing side when a non-protruding standard arm is required.



A154

Angle mounting plate

A122 can be used when the frame depth exceeds 200 mm.



A122



Door closer ASSA ABLOY DC300



ASSA ABLOY DC300

ASSA ABLOY DC300

Application

The ASSA DC300-series suits all types of exterior, interior and fire doors that require secure and controlled closing.

Function

Door closer body is made from cast aluminium. DC300 is a compression spring door closer with high quality hydraulic oil and temperature compensating valves.

Features

- Adjustable spring force 3-6 EN
- Max. door width 1400 mm
- Can be installed on door leaf or frame
- Closing and latching speed is adjustable with valves
- Adjustable arm height 14 mm
- Back check is adjustable from 75° as standard
- Delayed closing between 180°-70° as option
- Pressure relief valves for protection of the door closer
- Temperature compensating valves
- Easy mounting with adjustable arm
- Dimensions: length 260 mm, height 60 mm, depth 47 mm
- Removable body cover in several colors: silver, white, black and brown. Finishes available on request: NCS and RAL
- EN 1154
- CE-certified

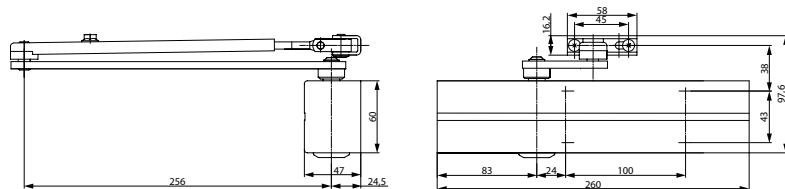

Door closer ASSA ABLOY DC300

ASSA ABLOY DC300

Door closer body

DC300 size 3-6 EN adjustable
 DC300DA size 3-6 EN adjustable
 DC347 size 5-7 EN adjustable
 Max. door width 1400 mm (3-6), 1600 mm (5-7)
 Latching and closing speed, delayed closing and back check adjustable with valves.
 Back check (BC) delayed closing (DA)
 Adjustable arm height 14 mm



Door closer body

Accessories

Standard arm

L190 frame depth 0-100 mm
 L199 frame depth 0-100 mm non detachable
 L198 frame depth 100-200 mm
 D3014 frame depth 0-70 mm
 L197 frame depth 0-70 mm for DC347BC



L190/L199/L198/L197



DC30014



L191



G195

Hold open arm

L191 frame depth 0-70 mm
 Max. hold-open angle 150°
 Blocking function can be switched on and off.
 (Not for fire doors)

Sliding arm

G195 can be used if design is preferred.



A152

A153

Hold-open accessories

A152 for sliding arm G195

Opening damper

A153 for sliding arm G195



A120

Mounting plate

A120 can be used for a narrow frame or rebated door leaf. Suits Dorma and Geze.



A154

Angle mounting plate

A154 for mounting on closing side when a non-protruding standard arm is required.



A123

Angle mounting plate

A123 can be used when the frame depth exceeds 200 mm



Mounting on opening side

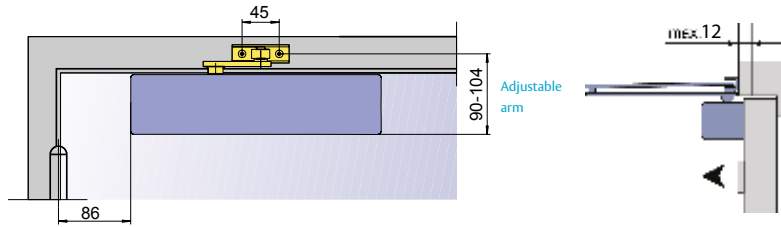

Mounting on closing side

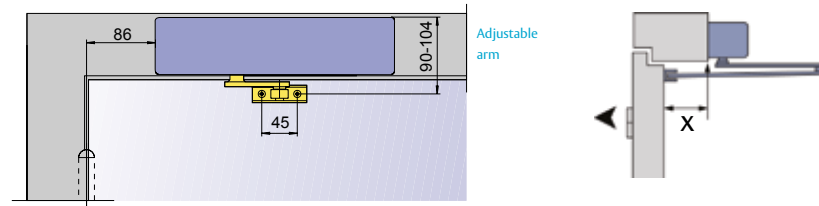

Standard arm

- L190 X = 0-100 mm
- L199 X = 0-100 mm
- D3014 X = 0-70 mm

Hold-open arm

- L191 X = 0-70 mm

Extended standard arm

- L198 X = 100-200 mm

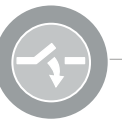

Accessory dimensions, DC200 and DC300

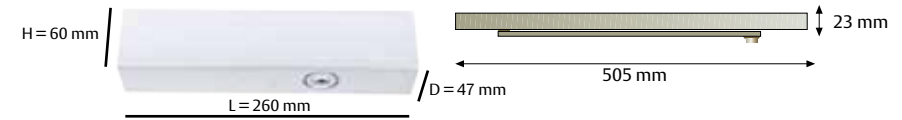

Door closer body D2001/DC30001

Sliding arm G195

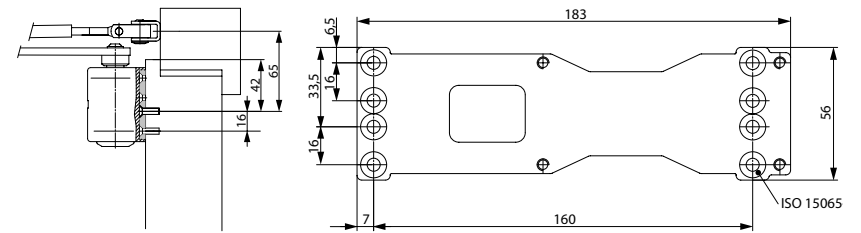

Mounting plate A120

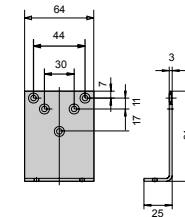

Parallel arm mounting plate A154



Angle mounting plate A122, A123

Mounting examples

Normal mounting plate

Frame mounting

Mounting with angel mounting plate

Mounting with parallel arm mounting plate

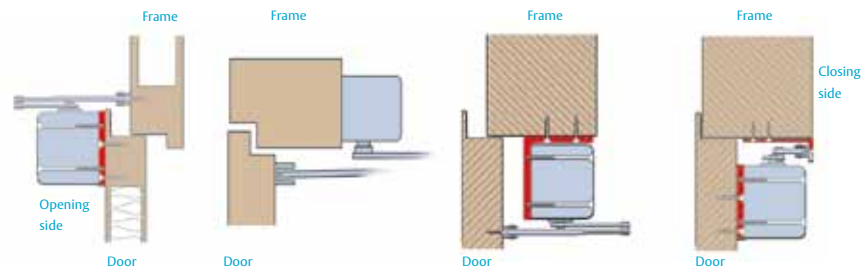



ASSA ABLOY DC500

ASSA ABLOY DC500

Application

The ASSA ABLOY DC500-series suits all types of interior and fire doors that require secure and controlled closing.

Function

The door closer is made from cast aluminium. DC500 is a cam action door closer used with a sliding arm that has a constant closing force. An advantage of the cam action technique is that the opening force is less than for a normal door closer.

Features

- Adjustable spring force 1-4 EN
- Max. door width 1100 mm
- Can be installed on door leaf or frame
- Closing and latching speed is adjustable with valves
- Adjustable arm height 14 mm
- Pressure relief valves for protection of the door closer
- Temperature compensating valves
- Easy mounting with adjustable arm
- Dimensions: length 270 mm, height 64 mm, depth 57 mm
- Removable body cover in several colors: silver, white and brown. Finishes available on request: NCS and RAL.
- EN 1154
- CE-certified

Adjusting latching and closing speed, delayed closing and back check

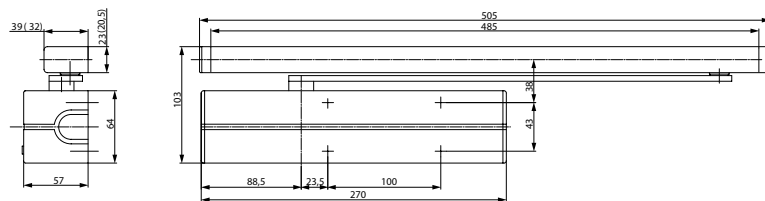
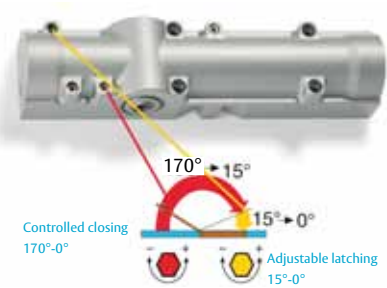

ASSA ABLOY DC500

Door closer body

DC500 size 1-4 EN adjustable
Max. door width 1100 mm.
Latching and closing speed adjustable with valves.
Adjustable arm height 14 mm.



Door closer body DC500

Accessories

Sliding arm

G195 can be used with DC500.



G195

Hold-open accessories

A152 for sliding arm G195.



A152

Opening damper

A153 for sliding arm G195.



A153

Angle mounting plate

A104 used with sliding arm G195 when door closer body is mounted on closing side of door leaf.



A104

Mounting plate

A120 can be used for a narrow frame or rebated door leaf.



A120

Mounting plate

A115 used with sliding arm G195 and G460-464.



A115



Mounting on opening side

DC500
ASSA ABLOY door closer DC500 mounted on opening side with sliding arm G195. If required the door can be set to open up to 170°.

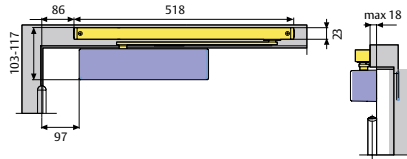

DC500
Frame mounting of ASSA ABLOY door closer DC500 with sliding arm G195 on openings side. If required the door can be set to open up to 170°.

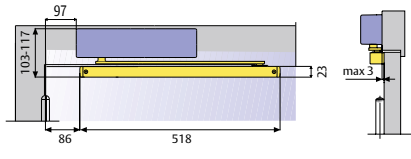

Mounting on closing side

DC500
Frame mounting of ASSA ABLOY door closer DC500 with sliding arm G195 on closing side. Opening angle is limited to between 120° and 145° depending on technical circumstances. Door stop A153 is recommended to avoid damage to the wall or door closer.

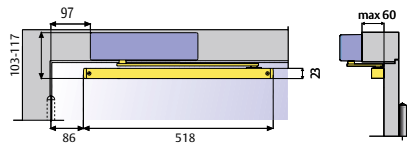

DC500
Door leaf mounting of ASSA ABLOY Door closer DC500 with sliding arm G195 on closing side. Opening angle is limited to between 120° and 145° depending on technical circumstances. Door stop A153 is recommended to avoid damage to the wall or door closer.

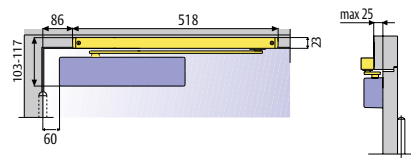

Accessory dimensions DC500



Door closer body DC500

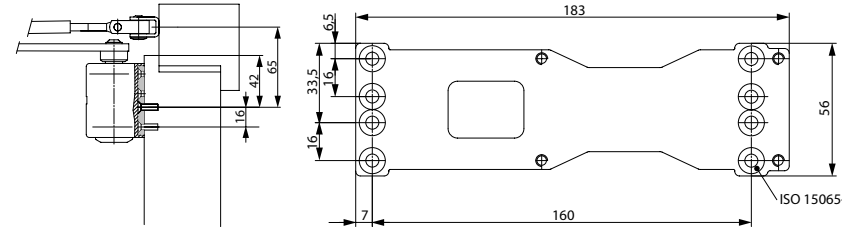

Mounting plate A120

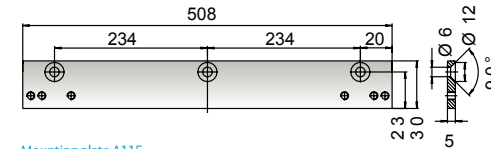

Mounting plate A115

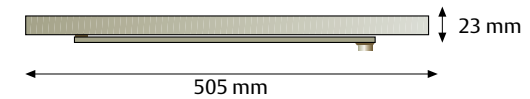

Sliding arm G195

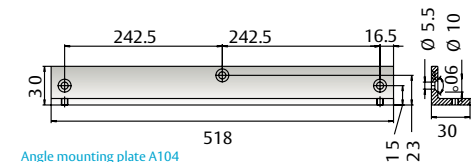

Angle mounting plate A104



ASSA ABLOY DC700

ASSA ABLOY DC700

Application

The ASSA DC700-series suits all types of exterior, interior and fire doors that require secure and controlled closing.

Function

The door closer is made from cast aluminium. DC700 is a cam action door closer used with a sliding arm that has a constant closing force. An advantage of the cam action technique is that the opening force is less than for a normal door closer.

Features

- Adjustable spring force 3-6 EN
- Max. door width 1400 mm
- Can be installed on door leaf or frame
- Closing and latching speed is adjustable with valves
- Adjustable arm height 14 mm
- Back check is adjustable from 70° as standard
- Delayed closing between 170°-70° as option
- Pressure relief valves for protection of the door closer
- Temperature compensating valves
- Easy mounting with adjustable arm
- Dimensions: length 270 mm, height 64 mm, depth 57 mm
- Removable body cover in several colors: silver, white, gold and brown. Finishes available on request: NCS and RAL
- EN 1154
- CE-certified

Adjusting latching and closing speed, delayed closing and back check

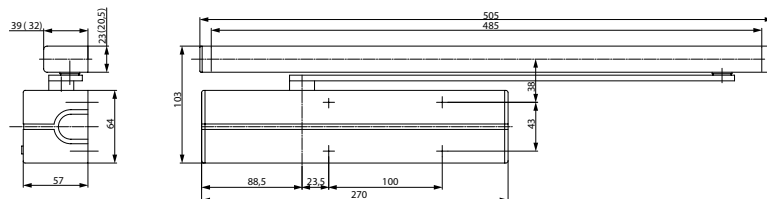
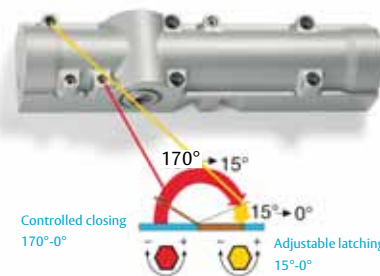

ASSA ABLOY DC700

Door closer body

DC700 size 3-6 EN adjustable.
DC700DA size 3-6 EN adjustable.
Max. door width 1400 mm. Latching and closing speed, delayed closing and back check adjustable with valves.
Back check (BC) delayed closing (DA).
Adjustable arm height 14 mm.



Door closer body DC700

Accessories

Sliding arm

G195 can be used with DC700/DC700DA.



G195

Hold-open accessories

A152 for sliding arm G195.



A152

Opening damper

A153 for sliding arm G195.



A153

Angle mounting plate

A104 used with sliding arm G195 when door closer body is mounted on closing side of door leaf.



A104

Mounting plate

A120 can be used for a narrow frame or rebated door leaf. Suits Dorma and Geze.



A120

Mounting plate

A115 used with sliding arm G195, G460 and G461-464.



A115



Dimensions door closer ASSA ABLOY DC700

Mounting on opening side

DC700/DC700DA

ASSA ABLOY door closer DC700 mounted on opening side with slide arm G195. If required the door can be set to open up to 170°.

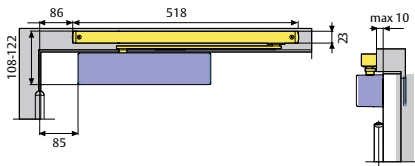

DC700/DC700DA

Frame mounting of ASSA ABLOY door closer DC700 with slide arm on openings side. If required the door can be set to open up to 170°.

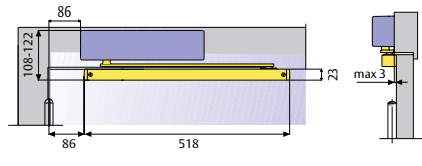

Mounting on closing side

DC700/DC700DA

Frame mounting of ASSA door closer DC700 with side arm on closing side. Opening angle is limited to between 120° and 145° depending on technical circumstances. Door stop A153 is recommended to avoid damage to the wall or door closer.

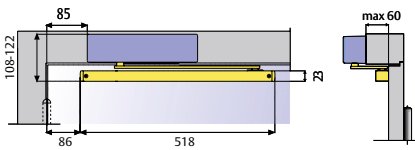

DC700/DC700DA

Door leaf mounting of ASSA Door closer DC700 with side arm DC700 on closing side. Opening angle is limited to between 120° and 145° depending on technical circumstances. Door stop A153 is recommended to avoid damage to the wall or door closer.

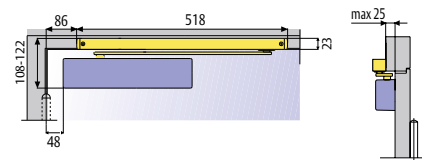

Dimensions door closer ASSA ABLOY DC700



Accessory dimensions, DC700

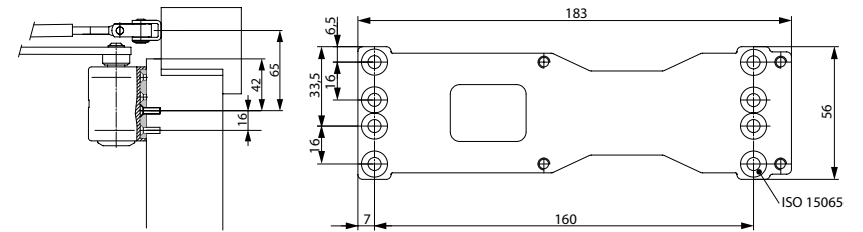

Mounting plate A120

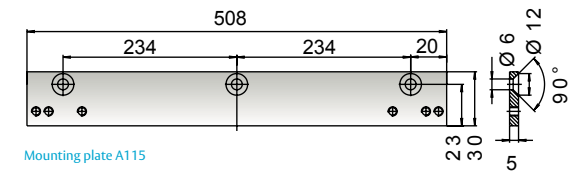

Mounting plate A115

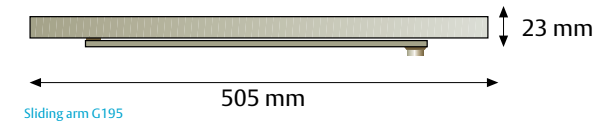

Sliding arm G195

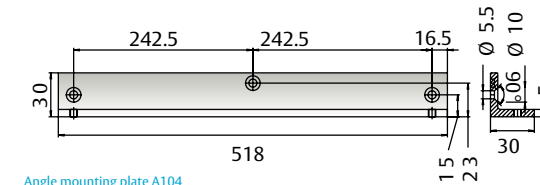

Angle mounting plate A104



Door closers for fire- and smoke separation doors

Application

The ASSA fire door closer fulfils the demands within EN for most types of fire separation doors. Suitable for surveillance of one or several fire rated doors. These types of doors are common in hospitals, elderly care centres, kinder gartens, hotels, public buildings and industrial buildings. The ASSA fire door closer system guarantees an easy and practical system for total fire security for single or double doors with a mechanical coordinator.

The ASSA ABLOY DC640 with built-in electro-hydraulic hold-open function in door closer DC640, suits all types of fire doors where secure and controlled is demanded. Can be used with standard arm or sliding arm. With free swing arm ASSA DC640, the door(s) will remain free for normal opening. In case of fire or power failure, the door(s) will be closed securely.

Features

- Electro-hydraulic door closer with magnet hold-open function
- Adjustable spring power 2-6 EN
- Can be mounted on door leaf or frame
- Adjustable closing- and latching speed with valve
- Axle adjustable 14 mm in height
- Back check adjustable from 75°
- Standard- and sliding arm with fixed hold-open angle
- Standard- and sliding arm with free swing function
- Power 24 V DC
- Magnet hold-open angle 70°-180°
- Dimensions: length 395 mm, height 68 mm, depth 62 mm
- CE-certified

Adjusting latching and closing speed, delayed closing and back check

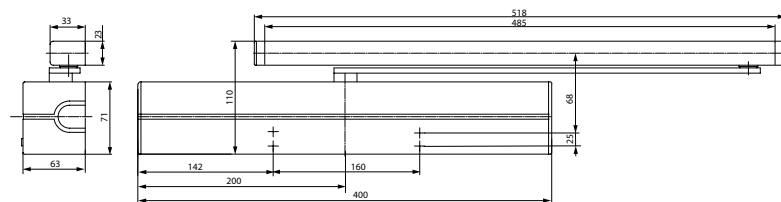
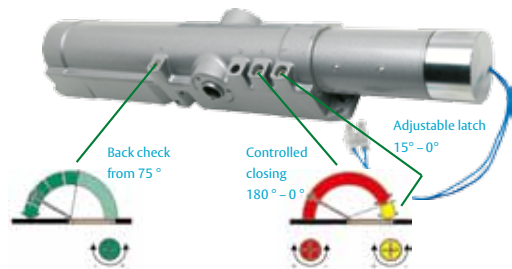

Door closer body

DC640 size 2-6 adjustable
Max. door width 1400 mm with standard arm,
1 400 mm with sliding arm.
Closing and latching speed and back check adjustable with valves.
Back check (BC).
Adjustable arm height 14 mm.
Mounting plate included.

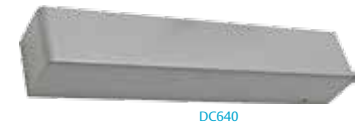

Accessories

Standard arm

L190 frame depth 0-100 mm
L199 frame depth 0-100 mm non-detachable
L198 frame depth 100-200 mm
D3014 frame depth 0-70 mm



Standard arm with free swing function

L690 frame depth 0-100 mm.



Sliding arm

G195 can be used if design is preferred.



Sliding arm with free swing function

G694 can be used if design is preferred.

Opening damper

A153 for sliding arm G195/G694.



Door coordinator

For coordination of double doors within a fire cell. Mounted in the frame's upper half on closing side. ASSA 2000K for double doors width up to 2 000 mm. ASSA 2000L for double doors width more than 2 000 mm.

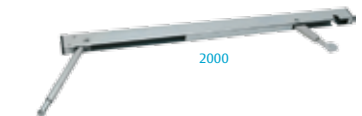

Door cam

For double doors with coordinator within a fire cell. Mounted on upper half of passive leaf. When exiting through passive door leaf the door cam will set the active door in motion to secure the function of the door coordinator.





ASSA ABLOY DC640

The ASSA ABLOY DC640 door closer housing with built-in electro-hydraulic hold-open function can be used with standard arm or slide arm for a constant hold-open position between 70°-180°, or with a free swing function with standard arm or sliding arm with a hold-open position between 70°-180°. ASSA ABLOY DC640 can be mounted on both door leaf and frame. Fits both right and left doors.

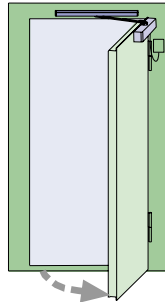

Mounting on opening side

ASSA ABLOY DC640 door closer housing with standard arm L190 for constant hold-open function, hold-open angle 70°-180°. DC640 door closer housing with standard arm L690 for free swing function, hold-open angle 70°-180°.

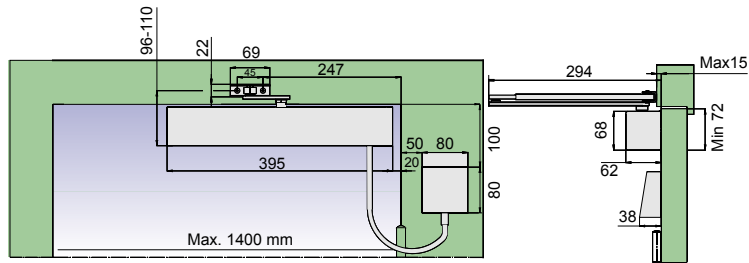

DC640 door closer housing and sliding arm G195 for constant hold-open function, hold-open angle 70°-180°. DC640 door closer housing with sliding arm G694 for free swing function, hold-open angle 70°-180°.

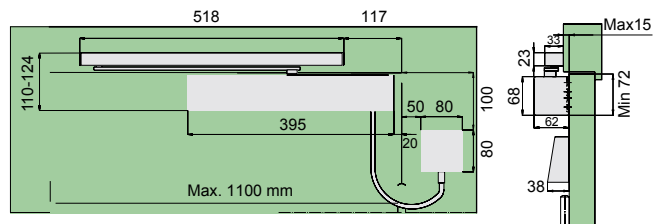

Mounting on closing side

ASSA ABLOY DC640 door closer housing with standard arm L190 for constant hold-open function, hold-open angle 70°-180°. DC640 door closer housing with standard arm L690 for free swing function, hold-open angle 70°-180°.

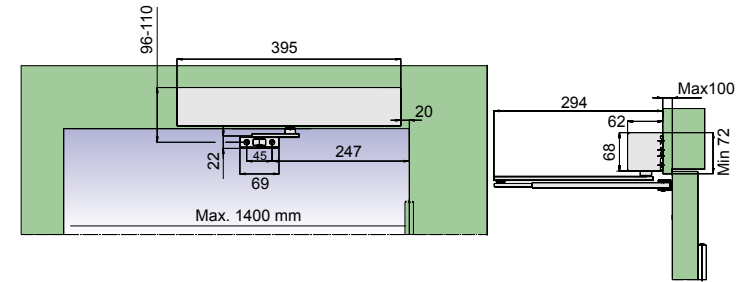

DC640 door closer housing and sliding arm G195 for constant hold-open function, hold-open angle 70°-120°. DC640 door closer housing with sliding arm G694 for free swing function, hold-open angle 70°-120°.

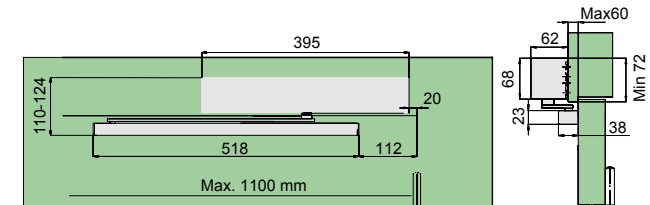



Door closer for fire- and smoke separation doors

Application

ASSA fire door closers meet the requirements for most types of fire doors. They are well-suited for controlling one or more fire-rated doors e.g. in hospitals, apartment buildings for the elderly, day-care centres, hotels, public areas and industrial complexes. Fire doors in a building with fire cells must function if a fire breaks out, to facilitate for both emergency evacuation and for the fire department. Areas that require doors with a hold-open device should have an electromechanical hold-open function combined with smoke detectors and/or be connected to an automatic fire alarm. In the case of fire or smoke development, a smoke detector and/or fire alarm the control unit will release the electromechanical hold-open device. The door closer is activated and closes the door or doors in the correct order with a coordinator.

Features

- Door closer body is made from cast aluminium
- Removable body cover in several colours: silver, white and brown
- Finishes available on request: NCS and RAL
- Adjustable closing force, 3-6 EN
- Available with standard sliding arm and hold-open device for sliding arm
- Concealed fitting
- Temperature compensating valves
- CE-certified
- EN 1154, 1155 and 1158

Adjusting latching and closing speed, delayed closing and back check

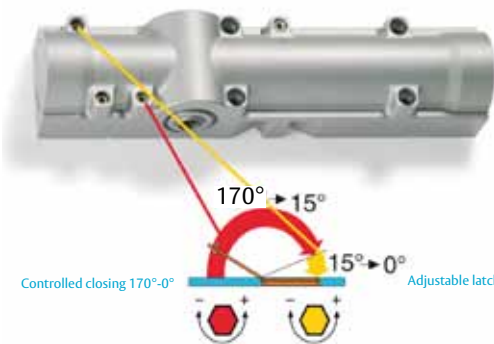

Hold-open magnets are recommended on extra large and heavy doors over 1250 mm, or doors where the hold-open angle must be greater than 130°.

Controlled closing 170°-0°

Adjustable latching 15°-0°



Door closer body

DC700 size 3-6 EN adjustable.
Max. door width 1400 mm. Latching and closing speed, back check adjustable with valves.
Back check (BC).
Adjustable arm height 14 mm.



Door closer body DC700

DC500 size 1-4 EN adjustable

Max. door width 1100 mm.
Latching and closing speed adjustable with valves.
Adjustable arm height 14 mm.



Door closer body DC500

A151 pivot block

Is used on double doors on the active door leaf, together with G461, when a door opener is required on the active door leaf and a door closer on the passive door leaf.



Door closer body A151

Sliding arm systems

G460 sliding arm with electromechanical hold-open function for single door.

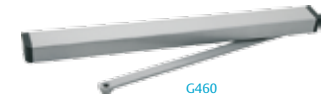

G460

G461 sliding arm for double doors with built-in coordinator.



G461



ASSA ABLOY G460-G464

G462 sliding arm for double doors with built-in coordinator and electromechanical hold-open function for the active and passive door leaf.



G464 sliding arm for double doors with built-in coordinator and electromechanical hold-open function for the passive door leaf.



Accessories

Mounting plate

A120 can be used for a narrow frame or rebated door leaf. Suits Dorma and Geze.



A115 used with sliding arm G460-464



Angle mounting plate

A116/A117 are used for for mounting on the closing side in combination with sliding arms G460-464 when the frame is deeper than 30 mm. A116 is for mounting th sliding arms and A117 to cover the space between th mounted A116 plates. A117 is adjustable to fit the dc width.



Mounting on opening side

Sliding arm	Door width	Hold-open angle	Opening angle	Min. door leaf width, passive door
G460	max. 1400 mm	80°-130°		
G461	1250-2800 mm		upp till 170°	min. 350 mm
G462	1250-2800 mm	80°-130°		min. 350 mm
G464	1250-2800 mm	80°-130°		min. 350 mm

Mounting on closing side

Sliding arm	Door width	Hold-open angle	Opening angle	Min. door leaf width, passive door
G460	max. 1400 mm	80°-120°		
G461	1400-2800 mm		80°-120°	min. 400 mm
G462	1400-2800 mm	80°-120°		min. 400 mm
G464	1400-2800 mm	80°-120°		min. 400 mm



ASSA ABLOY G460

The ASSA sliding arm with electromechanical hold-open function is used together with ASSA door closer DC700-series. Adjustable opening angle between 80 - 130 degrees. Automatically closes when the electromechanical hold-open device is released by interrupting the power supply. Closing can be controlled by for instance external smoke detectors or similar devices. When manually closing the door it is recommended that a separate release switch is used. The sliding arm is mounted on the frame of either the closing or the opening side. Suitable for both right or left handed doors.

Mounting on opening side

ASSA DC700/G460

Door closer ASSA DC700 with sliding arm G460 for mounting on opening side.

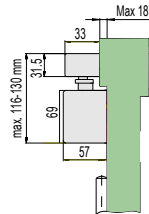
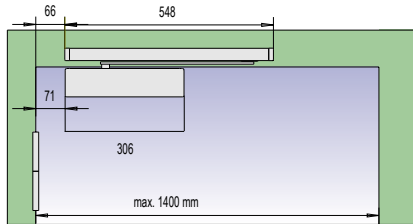

Mounting on closing side

ASSA DC700/G460

Door closer ASSA DC700 with sliding arm G460 for mounting on closing side.

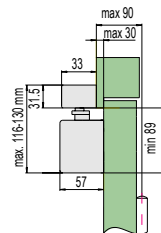
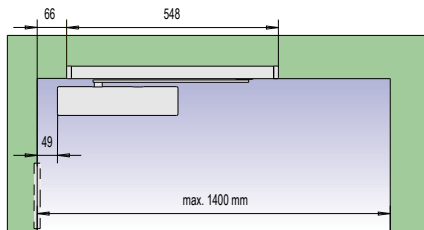

ASSA ABLOY G461-G464

The ASSA sliding arm with electromechanical hold-open function and integrated door coordinator is used with the ASSA DC700 door closer. Adjustable opening angle between 80-130 degrees. Automatically closes when the electromechanical hold-open device is released by interrupting the power supply. Closing can be controlled by for instance external smoke detectors or similar devices. When manually closing the door it is recommended that a separate release switch is used. Each door half can individually be set in the open position, depending on which sliding arm is used. The door coordinator ensures that the respective door door sides close in the correct order. The sliding arm is mounted on the frame of either the closing or the opening side. Suitable for both right or left handed doors.

Mounting on opening side

ASSA ABLOY DC700/G461-G464

Door closer ASSA DC700 with sliding arm G461-G464 for mounting on opening side.

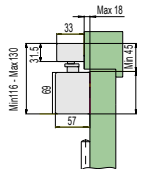
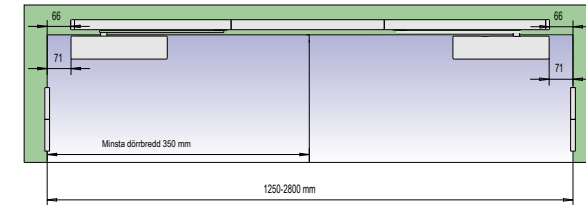

Mounting on closing side

ASSA ABLOY DC700/G461-G464

Door closer ASSA DC700 with sliding arm G461-G464 for mounting on closing side.

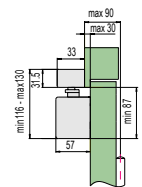
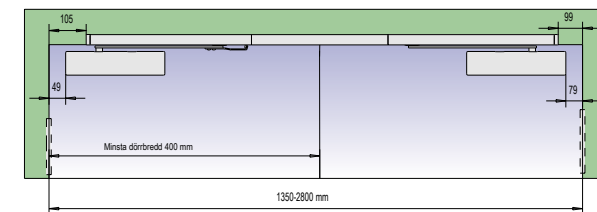

Door control

Door control



Technical information for mounting on opening side
ASSA ABLOY G461/G462/G464

G461

- Sliding arm ASSA ABLOY G461 with built-in door coordinator for double door
- The sliding arm is mounted on the door frame on the opening side
- Suits both right and left doors
- Opening angle is up to 170° depending on the door construction
- Door width 1250 mm-2800 mm

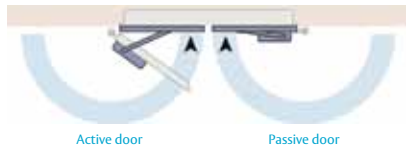

G462

- Sliding arm ASSA ABLOY G462 with electro-mechanical hold-open function for the active and passive door leaf
- Electromechanical opening angle 80° – 130°
- Sliding arms are mounted on opening side
- Suits both right and left doors
- Door width 1250 mm – 2800 mm

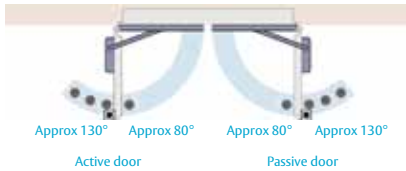

G464

- Sliding arm ASSA ABLOY G464 with electro-mechanical hold-open function for the passive door leaf
- The active door leaf is opened manually.
- Electromechanical opening angle 80° – 130°
- Sliding arms are mounted on opening side
- Suits both right and left doors
- Door width 1250 mm – 2800 mm



Technical data	G460	G461	G462	G464
Nominal voltage 24 VDC	x		x	x
Current consumption 60 mA	x			x
Current consumption 120 mA			x	
Integrated mechanical door coordinator		x	x	x



Technical information for mounting on closing side
ASSA ABLOY G461/G462/G464

G461

- Sliding arm ASSA ABLOY G461 incorporates a built-in door coordinator for double doors
- The sliding arm is mounted on the door frame on the closing side
- Suits both right and left hand doors
- Opening angle is up to approx 120° depending on the construction of the door
- Door width 1400 mm – 2800 mm



G462

- Sliding arm ASSA ABLOY G462 with electro-mechanical hold-open function for the active and passive door leaves
- Electromechanical opening angle is 80° – 120°
- Sliding arms are mounted on closing side
- Suits both right and left hand doors
- Door width 1400 mm – 2800 mm



G464

- Sliding arm ASSA ABLOY G464 with electro-mechanical hold-open function for the passive door leaf
- The active door leaf is opened manually
- Electromechanical opening angle is 80° – 120°
- Sliding arm is mounted on the frame on the closing side
- Suits both right and left hand doors
- Door width 1400 mm – 2800 mm



Technical data	G460	G461	G462	G464
Nominal voltage 24 VDC	x		x	x
Current consumption 60 mA	x			x
Current consumption 120 mA			x	
Integrated mechanical door coordinator		x	x	x

Door control

Door control



ASSA ABLOY floor springs



ASSA ABLOY DC475

ASSA ABLOY DC475

Application

ASSA floor springs are suitable for perimeter and interior doors.

Features

- Adjustable spring force 3-6 EN
- Closing and latching force can be adjusted with valves
- Max. door width 1400 mm
- Max. opening angle is 180°
- D752 without hold-open function
- D755 has hold-open function 90°
- Length 365 mm, width 78 mm, dept 82 mm

Function

- Adjustable closing force
- Adjustable latching force

Adjustment of spring force and closing power

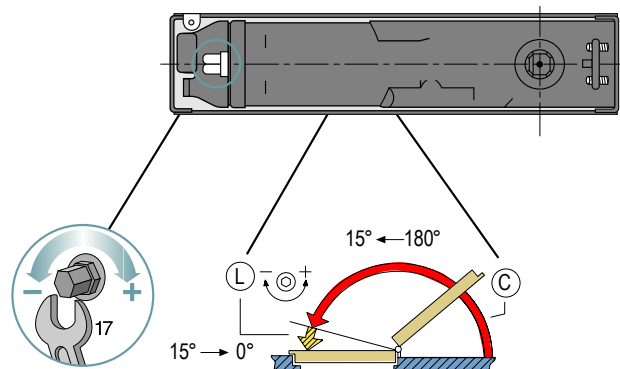

ASSA ABLOY floor springs



Accessories for AC384/AC392

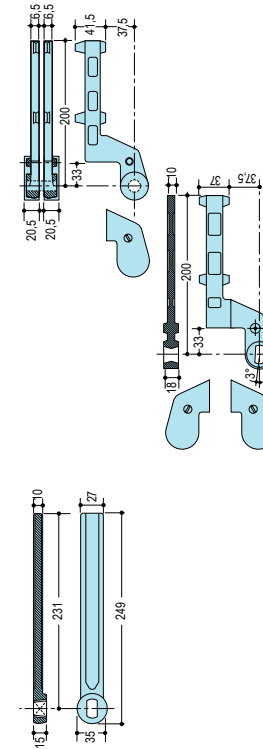

Dimensions

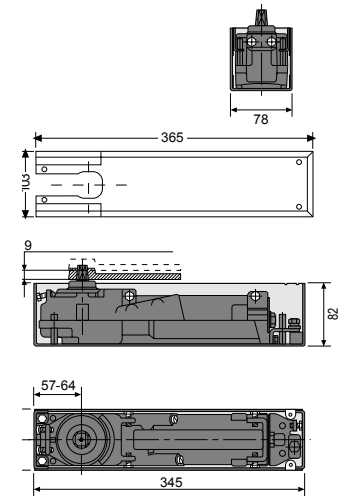

Installation

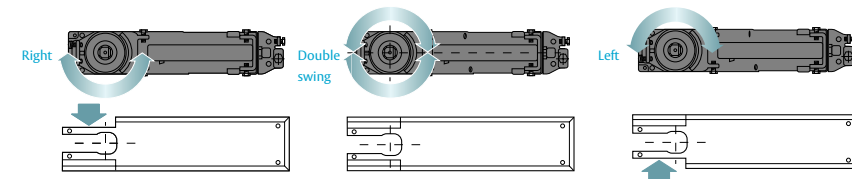



SWING DOOR OPERATORS

An easy way to welcome you

ASSA swing door operators provide a simple and convenient opening and closing solution.

The door operators are available with a host of user-friendly, flexible solutions for various applications with-out sacrificing security.

To meet the challenge of doors in public buildings, which are often in constant use, all day long, automatic doors must be of superior quality with reliable performance.

Security is conveniently solved with electro-mechanical locks, a combination which together with a door operator provides excellent flexibility in an automatic door environment.





ASSA ABLOY DA85

ASSA ABLOY DA85

Application

ASSA ABLOY DA85 door operators are suitable for most interior and exterior doors; available in either single or double-door solutions. The ASSA ABLOY DA85 is just as suitable for home modifications as it is in public environments, where requirements for a quiet and reliable opener are high, such as in department stores, schools, and hotels with high traffic-intensity environments and difficult operating conditions.

Function

- Door operators are electrohydraulic, extremely quiet, and completely soundless in open position.
- Can be mounted with a pull or push arm system.
- Door operators can be supplemented with ASSA's line of monitoring systems, which prevent the door from opening unexpectedly when a person is in the vicinity.
- Opening and closing speeds can be independently adjusted. The closing force can also be adjusted to handle different installations.
- For double doors with fire classification, supplement the door operator with the COOA mechanical door coordinator.
- The motor and hydraulics unit is integrated into a compact drive module, mounted by the electronics unit in the lightweight removable hood. The opener is fitted with various arm systems, depending on installation method.

Features

- Adjustable mechanical spring force 3–6 EN 1154
- Max. door width 1,400 mm
- Max. door weight 250 kg
- Adjustable opening and closing speed with valve
- For single or double doors
- Mechanical coordinator COOA
- Type-approved for fire doors E30/EI30 TG-0166/99
- Temperature range 15°C to + 50°C
- Max. opening angle 120°
- Remains open 0 – 30 seconds
- Hi-O technology
- Can be connected to different impulses in ASSA's product range
- Dimensions: length 716 mm, height 110 mm, depth 110 mm
- Removable hood in several colors: silver, white, gold, and brown. Available in NCS and RAL colors

Technical data

- Terminal voltage 230 V AC, 50 Hz
- Power supply 24 V DC
- Energy consumption max. 230 W



DA8500

- Control system housing, size 3–6 EN adjustable
- Door width 1,400 mm for push arm
- Door width for pull arm 1,400 mm
- Opening and closing speed adjustable with valves
- Adjustable open time 0–30 sec



DA8500

DA8510/DA8511/DA8512

- Standard arm, DA8510 frame depth 0–110 mm
- Extended standard arm DA8511 frame depth 110–235 mm
- Extension attachment DA8512 frame depth 235–360 mm



DA8510

DA8520

- A sliding arm can be used where the design requires mounting on the hinge side.



DA8520

DA8515/DA8516/DA8517

- An extension can be used where arm system and automatic door housing must be moved further apart because the automatic door housing is wall-mounted.
- DA8515 20 mm extension
- DA8516 50 mm extension
- DA8517 70 mm extension



DA8515

DA8530

- Mounting plate DA8530 can be used for easier attachment of the automatic control system. Length 716 mm, height 110 mm, thickness 8 mm.
- The DA8531 can be ordered in the desired length for single or double doors, height 160 mm thickness 8 mm.



DA8530



ASSA DA8550 and DA8558, elbow switches

Application

Impulse generator for door operators.

Features

- Fits swing door and sliding door operators.
- Small dimensions
- Wall or pole-mounted designs
- DA8550 made of plastic, for indoor use
Length 210 mm, width 80 mm, thickness 18 mm
- DA8558 made of aluminum, for outdoor use
- Dimensions: length 244 mm, width 78 mm, thickness 23 mm

Function

- Press the elbow switch to send an opening impulse to the door operator.



DA8550

DA8558

ASSA DA7051 and DA7052, radar

Application

Impulse generator for door operators.

Features

- Fits swing door and sliding door operators
- Easy to mount on wall or ceiling
- Radar can be mounted outdoors
- Adjustable sensitivity for height and length, as well as opening delay
- Power supplied by the door operator.
- Color: black
- Voltage: 12–24 VDC
- DA7051, standard radar with impulses from all directions
- DA7052, directional sensitive radar that does not give impulses from the side or when passing out of range

Function

- Detects all movements within the radar's radius of action
- Activates automatic control system to open door



DA7051, DA7052



ASSA DA8555 and DA8556, presence device input

Application

For monitoring interior and exterior doors. Recommended for high security swing door operators.

Features

- Available in 340 mm and 700 mm lengths
- Power supplied by the door operator.
- Voltage: 12-24 VAC/VDC

Function

- Monitors the door's movement area and registers movements
- Sensitivity regulated with potentiometer
- Monitoring area may be regulated vertically in three steps and continuously regulated horizontally
- Security sensor allows shorter opening time

DA8555 contains one monitoring eye
DA8556 contains two monitoring eyes



DA8555

ASSA DK, pull cord switch

Application

Impulse generator for door operators.

Features

- Fits swing door and sliding door operators
- Mounted on wall or ceiling
- Pull cord switch can be mounted externally

Function

- Pulling the cord sends an opening impulse to the door operator.



ASSA DK



ASSA KSS, key switch

Application

Impulse generator for door operators where considerable control is required.

Features

- Fits swing door and sliding door operators
- Wall or pole-mounted designs
- Key switch contact can be mounted externally
- Key switch provided without cylinder
- Dimensions: width 80 mm, height 130 mm, depth 54 mm

Function

- Turning the key sends the opening impulse to the door operator.



ASSA KSS

ASSA SKP, foot switch

Application

Impulse generator for door operators.

Features

- Fits swing door and sliding door operators
- Mounted on wall or floor
- Can be mounted externally
- Comes in stainless steel design
- Dimensions 114 x 114 mm

Function

- Touching the foot switch gives the opening impulse to the door operator.



ASSA SKP



ASSA 1200

Application

For doors in schools, hospitals, hotels, offices and public buildings.

Features

- For installation with catch hook 801, 804 and 806
- Finish: nickel plated. Also available in white or stainless steel finish
- Holding power 40 N standard
- Can be used in combination with door closer

Function

- Closes the door softly and effectively
- Adjustable closing speed with valve screw
- Keeps the door in closed position even without locks



ASSA 1200

ASSA 1500

Application

For doors in schools, hospitals, hotels, offices and public buildings.

Features

- Used together with catch hook 801, 804 and 806
- Finish: nickel plated. Also available in white or stainless steel finish
- Holding power 60 N standard
- ASSA 1500 is approved for fire doors E30 och E130 together with door closer without locks

Function

- Closes the door softly and effectively
- Adjustable closing speed with valve screw
- Keeps the door in closed position even without locks



ASSA 1500

ASSA 3000

Application

For elevator (lift) doors.

Features

- The catch hook is built into the door frame by the door manufacturer
- Finish: grey lacquered
- Holding power 40 N

Function

- Closes the door softly and effectively
- Adjustable closing speed with valve screw



ASSA 3000



Accessories for ASSA 1200 and ASSA 1500

Catch hook 801

Application
For horizontally mounted door closing devices.



Catch hook 801

Catch hook 804

Application
Designed for mounting where the frame depth exceeds the door leaf depth.
Level difference 3 mm - 18 mm = with spacer.
Level difference 18 mm - 28 mm = without spacer.

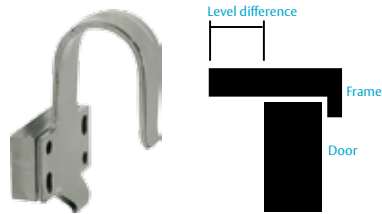

Catch hook 804

Catch hook 806

Application
Designed for flat mounting and for door frames up to 3 mm.



Catch hook 806

Angle plate 802

Application
For horizontal mounting on the frame side.



Angle plate 802

Lined area for notes.

Door control

Door control



HINGES

ASSA offers a comprehensive range of hinges meeting all requirements, from the simplest case to the most demanding security door.

ASSA hinges are available with a number of security enhancing functions, e.g. security pins that make it impossible to lift the door off.

Together we can even develop hinges to meet your or your company's specific requirements for design and construction.



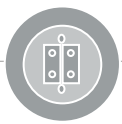

Right hand door, left hand door

Look at the door/window at the hinge side to determine whether it is right or left handed. If the hinges are on the right, it is a right hand door/window. If the hinges are on the left, it is a left hand door/window.

Traditional style

Hinges with traditional style welded knobs on hinge pins.

Security pins

Hardened steel pins that prevent forced entry on the hinge side of the door.

Centre line

When the hinge position has been determined, the position for preparations in the door (window, hatch etc.) can be defined. After the spring width *S* has been added, the preparation for the frame/cabinet/etc. can be determined.

Automatically closing doors

Positioning in vertical direction, see Doors below. Spring hinges 2220, 2228, and 2248 are positioned at the centre of the door.

French doors

Journal-supported hinges and coupling hinges are mounted 150 mm from the corner of the frame. The third hinge is placed in between the other two hinges. When four are hinges are fitted, the fourth one is positioned 150 mm below the top hinge. The distances are measured to hinge centre line.

Windows

Journal-supported hinges and coupling hinges are mounted 150 mm from the corner of the frame. The third hinge is placed in between the two other ones. The distances are measured to hinge centre line.

Doors

Door hinge positioning, see fig. 1-4.
Position of hinges 1 and 2, see fig 1 and 2.
Doors with height 21M (door leaf 2040 mm).
Doors with other height than 21M (door leaf 2 040 mm).

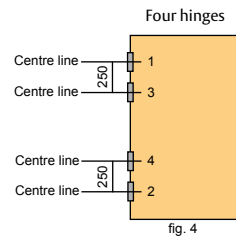
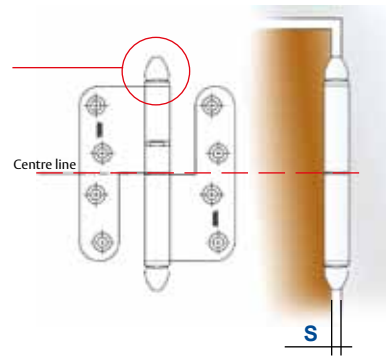

fig. 4

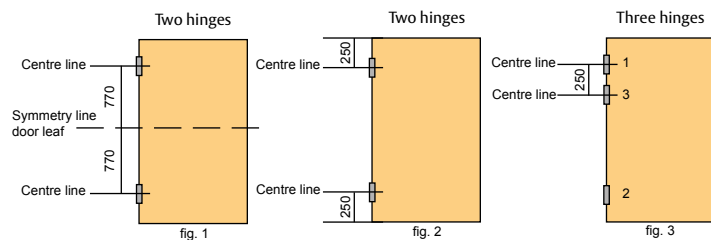
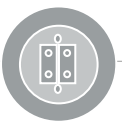

fig. 1

fig. 2

fig. 3



Grades/dimensioning

Classification of hinges

In accordance with standard EN 1935. Hinges can be classified depending on their strength and durability.

Windows, triple-glazed

For number of hinges, please see diagram 4. Height and width refer to external frame dimensions for single-light windows. 1 M = 100 mm.

Hinge types

For outward opening windows, use journal-supported hinges 1228 or coupling hinges 1206-65 or 1205. For increased protection against forced entry, use journal-supported hinges 3220. For inward opening windows, use journal-supported hinges 1223-100-1 and coupling hinges 1206-65 or 1205.

Windows, double-glazed

Please refer to diagram 5 for number of hinges per frame. Height and width refer to external frame dimensions for single-light windows. 1 M = 100 mm.

Hinge types

For outward opening windows, use journal-supported hinges 1222, 1228, 1212 and coupling hinges 1201, 1207-65 or 211.

For increased protection against forced entry, use journal-supported hinges 3220. For inward opening windows, use journal-supported hinges 1223-85, 1223-100 and coupling hinges 1201 or 211.

Grading table for lift-off hinges	
Hinge type	EN 1935
1212	5
1222	5
1228	8
1223-85	5
1223-100	8
2418	7
2472	9
2465	4
2010	10

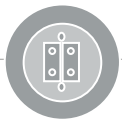

Grades/dimensioning

Grading table for journal-supported hinges	
Hinge type	Correspond to Standard SS-EN 1935
3012	Grade 14
3220	Grade 11
3225	Grade 13
3228	Grade 13
3229	Grade 13
3232	Grade 13
3244	Grade 13
3248	Grade 13
3278	Grade 14
3288	Grade 14
3240, 3241*	Grade 13

*N.B. Together with door leaf 3228, 3229 3244 or 3248.

Height (M = Module)											
16 M	3	3	3	3	3	3	3	3	3	3	3
15 M	3	3	3	3	3	3	3	3	3	3	3
14 M	3	3	3	3	3	3	3	3	3	3	3
13 M	3	3	3	3	3	3	3	3	3	3	3
12 M	3	3	3	3	3	3	3	3	3	3	3
11 M	2	2	2	2	3	3	3	3	3	3	3
10 M	2	2	2	2	2	3	3	3	3	3	3
9 M	2	2	2	2	2	2	3	3	3	3	3
8 M	2	2	2	2	2	2	2	3	3	3	3
7 M	2	2	2	2	2	2	2	3	3	3	3
6 M	2	2	2	2	2	2	2	3	3	3	3
5 M	2	2	2	2	2	2	2	3	3	3	3
4 M	2	2	2	2	2	2	2	3	3	3	3
Width	5 M	6 M	7 M	8 M	9 M	10 M	11 M	12 M	13 M	14 M	

Height (M = Module)														
19 M	3	3	3	3	3	3	3	3	3	3	3	3	3	
18 M	3	3	3	3	3	3	3	3	3	3	3	3	3	
17 M	3	3	3	3	3	3	3	3	3	3	3	3	3	
16 M	3	3	3	3	3	3	3	3	3	3	3	3	3	
15 M	2	2	2	2	3	3	3	3	3	3	3	3	3	
14 M	2	2	2	2	3	3	3	3	3	3	3	3	3	
13 M	2	2	2	2	3	3	3	3	3	3	3	3	3	
12 M	2	2	2	2	2	3	3	3	3	3	3	3	3	
11 M	2	2	2	2	2	3	3	3	3	3	3	3	3	
10 M	2	2	2	2	2	3	3	3	3	3	3	3	3	
9 M	2	2	2	2	2	3	3	3	3	3	3	3	3	
8 M	2	2	2	2	2	2	2	2	2	3	3	3	3	
7 M	2	2	2	2	2	2	2	2	2	3	3	3	3	
6 M	2	2	2	2	2	2	2	2	2	3	3	3	3	
5 M	2	2	2	2	2	2	2	2	2	3	3	3	3	
4 M	2	2	2	2	2	2	2	2	2	3	3	3	3	
Width	4 M	5 M	6 M	7 M	8 M	9 M	10 M	11 M	12 M	13 M	14 M	15 M	16 M	17 M

Selection and dimensioning

Door with spring hinges

When you have determined the weight and width of the door, please see diagram 1 for recommended size and number of hinges.

French doors

For number of hinges, please see the diagram. Height and width refer to external frame dimensions. 1 M = 100 mm. The number of coupling hinges is always 3.

Hinge types

French doors on ground floor

For outward opening French doors, use journal-supported hinges 3228, 3244 or 3248. For inward opening French doors, use journal-supported hinges 3229. For coupled French doors, use coupling hinges 1205.

French doors above ground floor

For outward opening French doors, use journal-supported hinges 3220. For inward opening French doors, use journal-supported hinges 3229.

For journal-supported hinges according to this recommendation the number of hinges is indicated in brackets in table 1.

When door closer is fitted add +20% to door weight.

When back-check door closer is fitted add +75% to door weight.

Height (M = Module)			
22 M	3	3	3 (4)
21 M	3	3	3 (4)
20 M	3	3	3 (4)
Width	8 M	9 M	10 M

Table 1

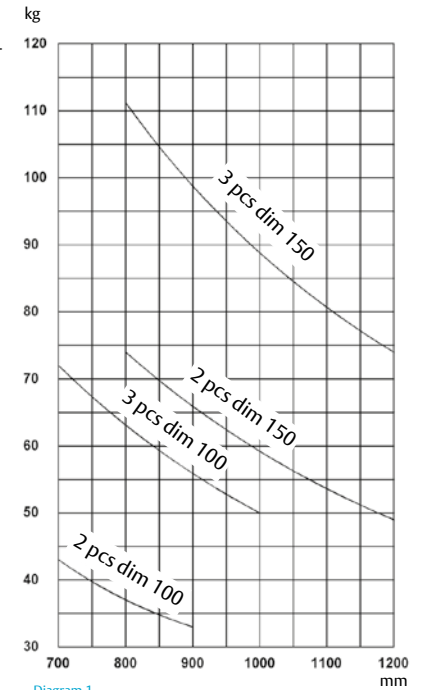
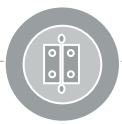

Diagram 1



Selection and dimensioning

The information below is a general recommendation. Variations may occur due to the product that the hinges are used on, the environment etc.

A. Exterior doors, light-weight exterior doors institutional doors etc.
Unrebrated doors: 3248, 3228, 3288, 3278
Rebrated doors: 3229

B. Interior doors, light-weight interior doors institutional doors etc.
Unrebrated doors: 3220, 2465, 2418
Rebrated doors: 3229

C. Steel doors
3012, 3012-01

D. Garage doors
3278, 3288

E. Automatically closing doors
Two way swing doors: 280
One way swing doors: 279
Unrebrated automatically closing doors: 2220, 2228, 2248

F. Outward opening French doors:
3228, 3244, 3248, 3210
Coupling hinges: 1206-65, 1206, 1207-65

G. Inward opening French doors: 3229
Coupling hinges: 1206-65

H. Outward opening windows
Triple-glazed: 1228, 3220
Double-glazed: 1222, 1212
Coupling hinges:
Triple-glazed: 1206-65, 1205
Double-glazed: 1201, 211, 1207-65

I. Inward opening windows
With weather seal: 1223-01-100
Without weather seal: 1223-100
Coupling hinges: 1201, 1206-65, 211, 1205

J. Butt hinges for hatches, cases, sheds, attics, collapsible tables, ladders etc. 5001

If the door weight is known, this should be cross-referenced with the width of the door from diagram 1 on the next page to identify which hinges should be fitted.

Note that while it is common practice to fit two hinges to lightweight doors, ASSA recommends that at least three hinges should always be fitted. This is especially important when a door closer is used.

The graph below can be used if positioning of the hinges is made after positioning on page 422.

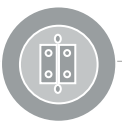

	Unrebrated	Rebrated
Field	1228, 2 pcs	1223-100, 3 pcs
1	2418, 2 pcs	
	3212, 2 pcs	
	3220, 2 pcs	
Field	1228, 3 pcs	3229, 2 pcs
2	2418, 3 pcs	
	3220, 3 pcs	
	3212, 3 pcs	
	K1227-110, 2 pcs	
Field	3210, 2 pcs	3229, 3 pcs
3	3211, 2 pcs	
	3225, 2 pcs	
	3228, 2 pcs	
	3232, 3 pcs	
	3244, 2 pcs	
	3248, 2 pcs	
	K1227-110, 3 pcs	
Field	3210, 3 pcs	3229, 4 pcs
4	3211, 3 pcs	
	3012, 2 pcs	
	3225, 3 pcs	
	3228, 3 pcs	
	3232, 4 pcs	
	3244, 3 pcs	
	3248, 3 pcs	
	3278, 2 pcs	
	3288, 2 pcs	
Field	3012, 3 pcs	
5	3210, 4 pcs	
	3211, 4 pcs	
	3225, 4 pcs	
	3228, 4 pcs	
	3248, 4 pcs	
	3278, 3 pcs	
	3288, 3 pcs	

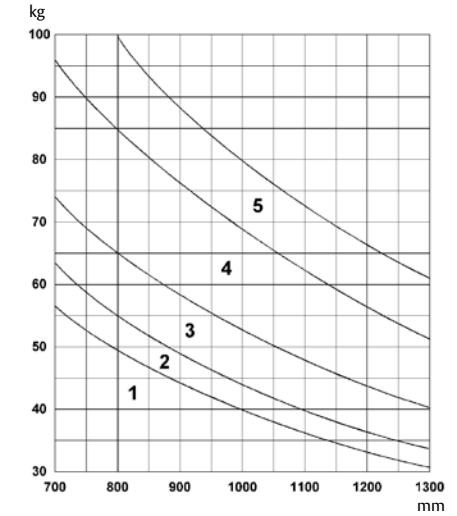
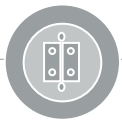

Diagram 1



As with all designs that include moving parts, hinges need some maintenance to function faultlessly over their entire life time. The amount of maintenance needed depends on e.g. opening frequency, strain and environment.

Maintenance consists of:

- overhaul
- cleaning
- lubrication

Overhaul

Overhaul of hinges should be carried out frequently. The overhaul interval is determined by opening frequency and load.

You should control the following at least once a year:

- function
- need for lubrication
- possible loose screws

This can be carried out in connection with the overhaul and control of locks, door closer, weather seals, glass panes, putty and painting.

Cleaning

As hinges wear, a fine black dust is spread around the bearing. The dust also often settles on the frame and the door/window/hatch. The best way to avoid the dust is to keep the hinges well-lubricated.

Function

Hinges should function easily, be undamaged and securely fastened in both frame and door. The door should not touch frame or threshold when it is closed. Damaged or worn-out hinges should be replaced. Loose screws should be tightened. Loose hinges impair the door function, increase wear on the hinges and make breaking-in easier.

Screws in newly installed doors must always be tightened after a few months when the wood in the frame and the door has dried.

When necessary, the hinges are adjusted according to the instructions below. However, the reason for adjustment should be carefully analysed before the actual adjustment is carried out. Hinges often get the blame for a badly functioning door, when in fact the real reason is a carelessly mounted frame or subsidence in the house.

It is useless for example to adjust the hinges of a heavy door if the frame is not fixed to the wall properly.

Before adjusting the hinges, check the following:

- Is the frame straight and level?
- Are the diagonal dimensions of the frame correct?
- Is the frame side straight in the rebate (does not bulge inwards or outwards)?
- Is the frame rebate width correct?
- Is the frame rebate width the same at different heights?
- Is frame side straight?
- Is the frame securely mounted in the wall?
- Is the wall stable enough to hold the frame?
- Is the frame mounted so that it cannot warp?
- Are the hinges securely fastened in the frame and door?
- Is the door leaf straight and level?

Do not attempt to adjust the hinges if you cannot answer all the above questions in the affirmative.

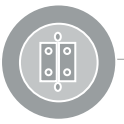

Lubrication

For lubrication of hinges, a water-free mineral or synthetic grease should be used. Do not use oil unless it is absolutely impossible to apply grease. It is very important to use right kind of lubricant, since stresses can be very high, especially on journal-supported hinges.

Lubrication of journal-supported lift-off hinges

The easiest way to lubricate the hinges is through the adjustment disc slot. Lift the door a couple of centimetres and apply the lubricant. Lift and lower the door a few times and open the door wide to spread the lubricant over the whole contact surface. The lifting of the door can be done easily with the help of a foot-operated door or board lifter.

Older journal-supported hinges without an adjustment disc slot are lubricated by lifting the door/window off and applying lubricant to the knuckle or on the journal. It is important to apply lubricant even on the top of the journal.

Hinges without an adjustment disc slot are lubricated either as older journal-supported hinges or by leaving the door hanging and screwing off the height adjustment screw, applying lubricant in the screw hole and retightening the screw. The lubricant is spread in the knuckle onto the contact surfaces.

Simple lift-off hinges (non- journal-supported) should be lubricated when the door/window is installed and the reafter when necessary. They are lubricated in the same way as journal-supported hinges. Make sure that the contact surface between the upper and lower part is well-lubricated.

After lubricating, wipe off any excess lubricant on the surface of the hinges with a dry cloth.

Lubrication of coupling hinges and butt hinges

In the case of these hinges it is not possible to reach the lubrication point. Consequently, machine oil that is not too thin should be applied. Wipe off excess oil afterwards. Sewing machine oil is too thin and should not be used.

Lubrication of spring hinges

In general, spring hinges should be demounted for satisfactory lubrication. Lubricate the spring as well, so that it does not squeak against the inside of the spring housing.

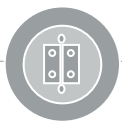

Lift-off hinges

1212, 1212-01

Application

For outward opening windows, unrebated hatches etc. and slot-guided coupled windows. Combine with 1207-65.

Material

- Zinc-plated steel
- 1212-01 of plastic

Features

- Right or left handed
- Connection part 1212-01

Accessories

- Recommended screws six TFX 4.5 x 25
- Recommended screw for coupling bracket one TFX 4.5 x 30

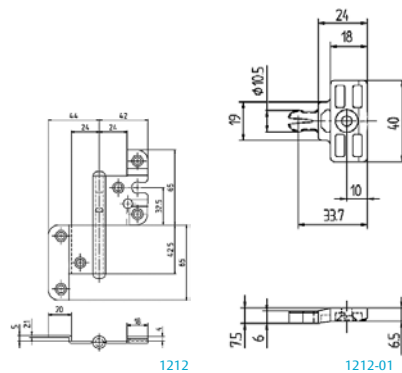

1222

Application

For outward opening windows, unrebated hatches etc.

Material

- Zinc-plated steel

Features

- Right or left handed
- Also available in traditional style

Accessories

- Recommended screws six TFX 4.5 x 25

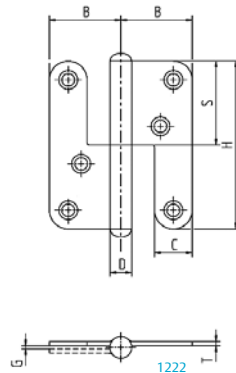

1228

Application

For outward opening windows, unrebated hatches etc.

Material

- Zinc-plated steel

Features

- Right or left handed
- Also available in traditional style

Accessories

- Recommended screws six TFX 4.5 x 25

Dimension (mm)					
Ref. No.	H	B	C	D	G
1222	85	36	19	11	1.6
1228	85	37	19	13.5	2

Dimension (mm)		Screw		
Ref. No.	S	T	Number	Dim.
1222	42.5	2.1	6	4.5 x 25
1228	42.5	2.7	6	4.5 x 25

Lift-off hinges

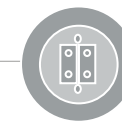

1223-100, 1223-85

Application

1223, for inward opening windows without weather seal. 1223-01, for inward opening windows with weather seal, only 100 mm.

Material

- Zinc-plated steel

Features

- Right or left handed

Accessories

- Recommended screws for 1223-85: six TFX 4.5 x 25
- Recommended screws for 1223-100: six TFX 5 x 30

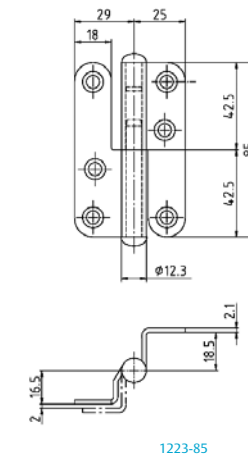

2418

Application

For outward opening windows and unrebated lighter doors.

Material

- Steel

Features

- Right or left handed
- Several pin lengths to facilitate mounting
- Powder lacquered hinges are not suitable for outward opening windows

Accessories

- Recommended screws: six TFX 4.5 x 30

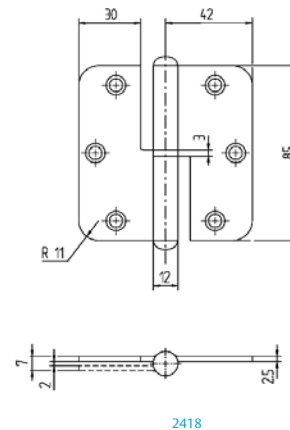

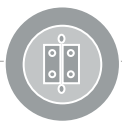

Journal-supported lift-off hinges

3220

Application

For unrebated doors, outward opening French doors and windows etc.

Material

- Zinc-plated steel
- Hardened steel pins

Features

- Right or left handed
- Journal-supported
- Also available in traditional style
- With adjustment disc slot for easy height adjustment

Accessories

- Recommended screws: six TFX 5 x 30
- Adjustment discs 249

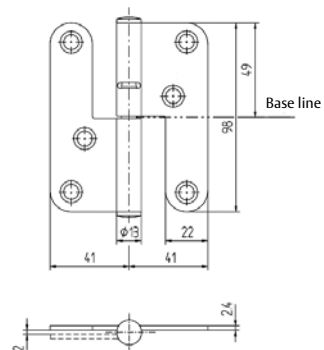

3220

3210

Application

For unrebated doors, outward opening French doors and windows etc.
Slot-guided. Slot; door 18 mm, frame 12 mm.

Material

- Zinc-plated steel
- Hardened steel pins

Features

- Right or left handed
- Journal-supported
- With adjustment disc slot for easy height adjustment

Accessories

- Recommended screws: six TFX 4.5 x 30
- Adjustment discs 249

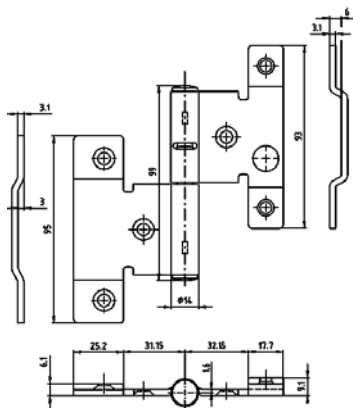

3210

Journal-supported lift-off hinges

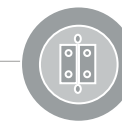

3211-1

Application

For unrebated doors and windows, slot-guided. Slot; door 17.3 mm, frame 12 mm.

Material

- Zinc plated with sealer
- Stainless steel pin

Features

- Right or left handed
- Journal-supported
- With adjustment disc slot for easy height adjustment

Accessories

- Recommended screws: eight 4.5 x 30
- Adjustment discs 249

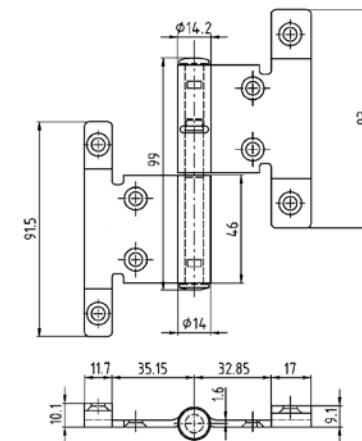

3211-1

3212

Application

For unrebated windows, slot-guided. Slot; door 17.3 mm, frame 12 mm.

Material

- Zinc plated with sealer
- Stainless steel pin

Features

- Right or left handed
- Journal-supported
- With adjustment disc slot for easy height adjustment

Accessories

- Recommended screws: eight 4.5 x 30
- Adjustment discs 249

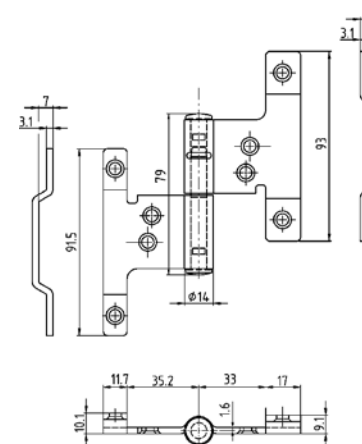

3212

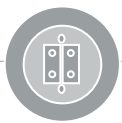

Journal-supported lift-off hinges

3228

Application

For unrebated doors, outward opening windows etc.

Material

- Zinc-plated steel. Black and blue with sealer. Zinc-iron.
- Hardened steel pins

Features

- Version 3228-08, for security doors
- Right or left handed
- Also available in traditional style
- Journal-supported
- With adjustment disc slot for easy height adjustment
- Can be combined with 3240 or 3241 on doors with steel frame

Accessories

- Recommended screws: eight TFX 5 x 30
- Can be complemented with frame-reinforcing mounting plate 248-28, fitted with machine screws. When using the mounting plate, four MFX 6 and two TFX 5 X 30 are recommended.
- Adjustment discs 249
- Security pins 2301 for 3228-08
- CE-certified

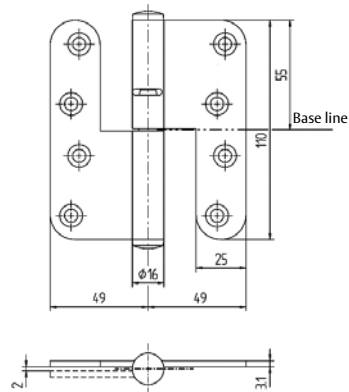

3228

3228-SS4

Application

For unrebated doors, outward opening French doors etc.

Material

- Stainless steel, SS 2343

Features

- Right or left handed
- Journal-supported
- With adjustment disc slot for easy height adjustment

Accessories

- Recommended screws: eight TFX 5 x 30 RF
- Adjustment disc 249
- CE-certified

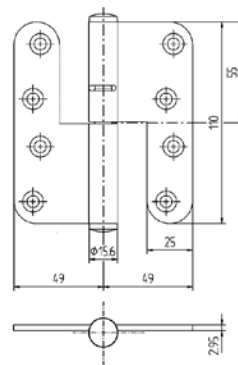

3228-SS

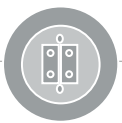

Journal-supported lift-off hinges

3244

Application

For unrebated doors etc.

Material

- Zinc-plated steel. Black and blue with sealer. Zinc-iron.
- Hardened steel pins

Features

- Right or left handed
- Also available in traditional style
- Half-symmetrical, journal-supported
- With adjustment disc slot for easy height adjustment
- Allows symmetrical mortise
- Can be combined with 3240 or 3241 on doors with steel frame

Accessories

- Recommended screws: eight TFX 4.5 x 25
- Adjustment discs 249
- CE-certified

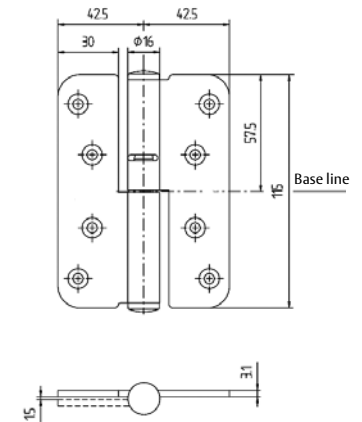

3244

3248

Application

For unrebated doors, outward opening French doors etc.

Material

- Zinc-plated steel, black and yellow zinc-iron
- Hardened steel pins

Features

- Right or left handed
- Also available in traditional style
- Half-symmetrical, journal-supported
- With adjustment disc slot for easy height adjustment
- Allows symmetrical mortise
- Can be combined with 3240 or 3241 on doors with steel frame

Accessories

- Recommended screws: eight TFX 5 x 30
- Can be complemented with frame-reinforcing mounting plate 248-48, fitted with machine screws. When using the mounting plate, four MFX 6 and two TFX 5 x 30 are recommended.
- Adjustment discs 249
- CE-certified

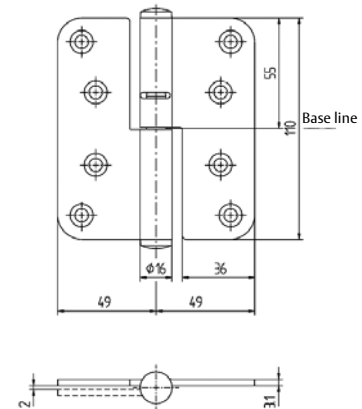

3248

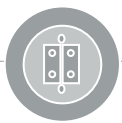

Journal-supported lift-off hinges

3229

Application

For rebated doors etc.

Material

- Zinc-plated steel
- Hardened steel pins

Features

- Right or left handed
- Journal-supported
- With adjustment disc slot for easy height adjustment
- Can be combined with 3240 or 3241 for doors with steel frame

Accessories

- Recommended screws: eight TFX 5 x 30
- Can be complemented with frame-reinforcing mounting plate 248-28, fitted with machine screws. For fitting the mounting plate, four MFX 6 and two TFX 5 x 30 are recommended.
- Adjustment discs 249
- CE-certified

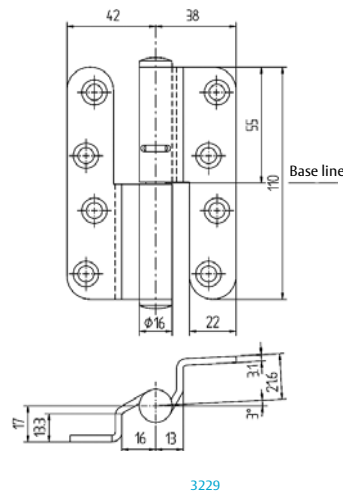

3232

Application

For anti-squeeze unrebated doors in day-care centres, hospitals etc.

Material

- Zinc-plated steel
- Hardened steel pins

Features

- Right or left handed
- Journal-supported
- With adjustment disc slot for easy height adjustment 26 mm turning allowance accommodates an antisqueeze rubber list
- Suits same preparation as 3228

Accessories

- Recommended screws: eight TFX 5 x 30
- Can be complemented with frame-reinforcing mounting plate 248-28, fitted with machine screws. For fitting the mounting plate, four MFX 6 and two TFX 5 x 30 are recommended.
- Adjustment discs 249
- CE-certified

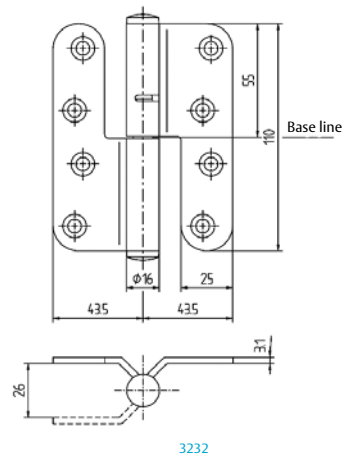

Journal-supported lift-off hinges

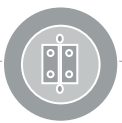

3240

Application

For steel frames. For use together with door leaf with hinges 3228, 3229, 3244 or 3248.

Material

- Zinc-plated steel
- Hardened steel pin

Features

- Right or left handed
- Journal-supported frame blade
- Stepless height adjustment

Accessories

- Recommended screws: three MFX 8 x 16

Variants = length of rolling

- 42.5
- 46
- 48
- 52
- 42.5 SS4
- 52 SS4

CE-certificate

- EN 1935 Grade13

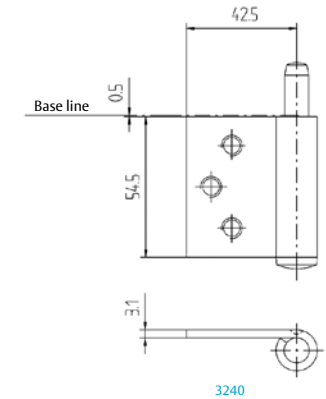

3241

Application

For steel frames. For use together with door leaf with hinges 3228, 3229, 3244 or 3248.

Material

- Zinc-plated steel
- Hardened steel pins

Features

- Right or left handed
- Journal-supported
- Recommended screws three MFX 8x16

Variants = length of rolling

- 46
- 49
- 52

CE-certificate

- EN 1935 Grade 13

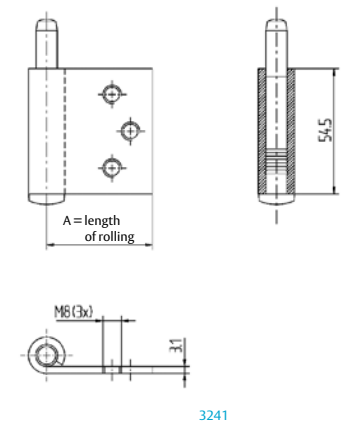

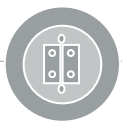

Journal-supported lift-off hinges

3225

Application

For unrebated doors, outward opening French doors and windows etc., security doors.

Material

- Zinc-plated steel
- Hardened steel pins

Features

- Right or left handed
- Journal-supported
- With adjustment disc slot for easy height adjustment

Accessories

- Recommended screws: eight TFX 5 x 30
- Can be complemented with frame-reinforcing mounting plate 248-28, fitted with machine screws. When fitting the mounting plate, four MFX 6 and two TFX 5 x 30 are recommended.
- Adjustment discs 249
- Security pins 2301

Variants

- 08

CE-certificate

- EN 1935 Grade 13

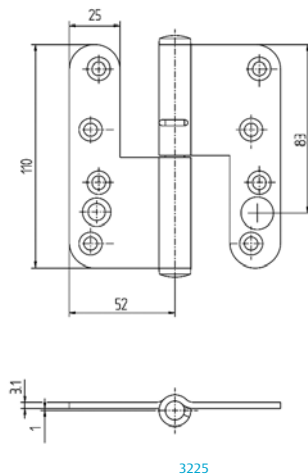

K1227

Application

For doors with special decorative demands.

Material

- Brass, polished or nickel-plated

Features

- Right or left handed
- With ball bearings

Accessories

- Recommended screws: eight TFX 5,5 x 30
- Can be complemented with frame-reinforcing mounting plate 248-28. In this case four screws MFX 6 and two wood screws according to above are recommended.
- Spare ball bearings 540-9.25

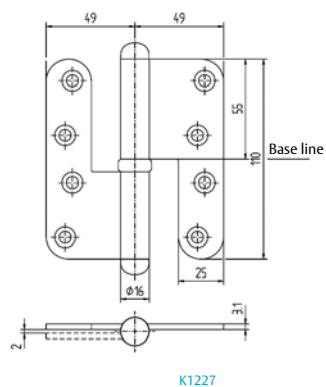

Journal-supported lift-off hinges

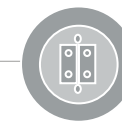

3278

Application

For unrebated doors, outward opening French doors etc.

Material

- Zinc-plated steel
- Hardened steel pins

Features

- Right or left handed
- Journal-supported
- With adjustment disc slot for easy height adjustment

Accessories

- Recommended screws: eight TFX 5 x 30
- Can be complemented with frame-reinforcing mounting plate 248-28, fitted with machine screws. For fitting the mounting plate, four MFX 6 x 30 and four TFX 5 x 30 are recommended.
- Adjustment discs 249

Variants

- 04
- 08
- 12

CE-certificate

- EN 1935 Grade 14

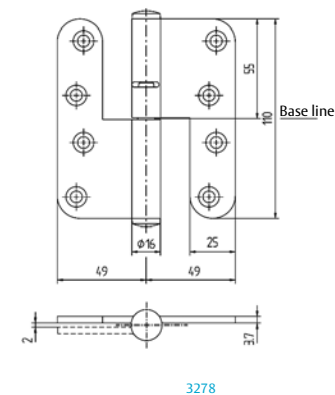

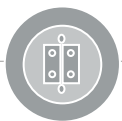

Journal-supported lift-off hinges

3288

Application

For unrebuted doors, outward opening French doors etc.

Material

- Zinc-plated steel
- Hardened steel pins

Features

- Right or left handed
- Half-symmetrical, journal-supported
- Allows symmetrical mortice
- With adjustment disc slot for easy height adjustment

Accessories

- Recommended screws: eight TFX 5 x 30.
Can be complemented with frame-reinforcing mounting plate 248-48, fitted with machine screws. For fitting the mounting plate, four MFX 6 and two TFX 5 x 30 are recommended.
- Adjustment discs 249

Variants

- 02
- 03
- 08
- 09
- 10
- 10 CRANK 3
- 13

CE-certificate

- EN 1935 Grade 14

3012

Application

For steel doors with steel frame.

Material

- Zinc-plated steel

Features

- Right or left handed
- Journal-supported
- With adjustment disc slot for easy height adjustment
- Slot hinge

Application

- Adjustment discs 249
- Screws depending on the frame design

CE-certificate

- EN 1935 Grade 14

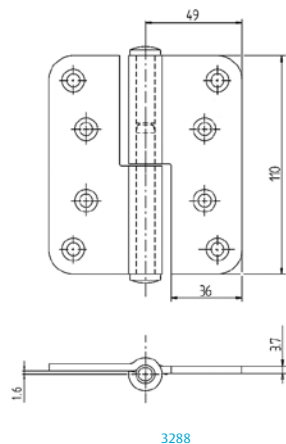

3288

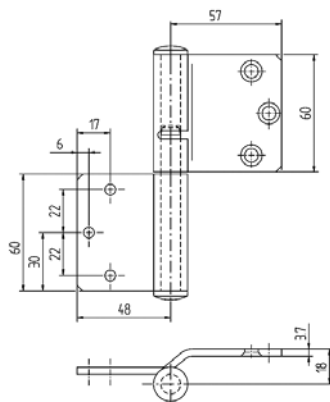

3012

Coupling hinges

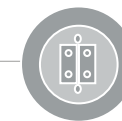

211-65

Application

Coupling hinges for windows.

Material

- Zinc-plated steel
- Pin of brass

Features

- Both halves countersunk on the rear

Accessories

- Recommended screws: six TFX 3 x 20

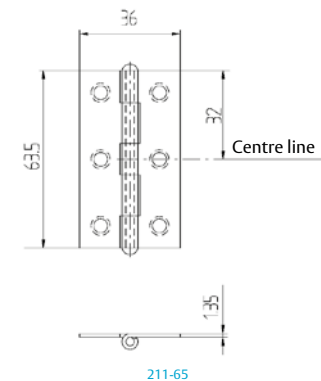

211-65

5000, 5001, 5002

Application

Butt hinges for furniture, hatches, cases etc.

Material

- Zinc-plated steel
- Pin of brass

Accessories

- Recommended screws according to the table below

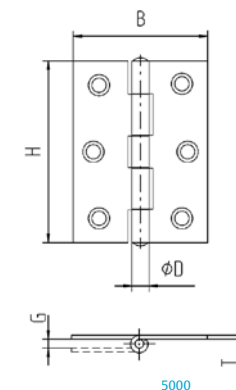

5000

Ref. No.	Dimensions (mm)					Screw	
	H	B	D	G	T	No.	Dim.
5000-50	50.5	31	5.5	3	1.25	6	3 x 20
5000-65	63.5	37	6	3.3	1.35	6	3 x 20
5001-50	50.5	40	5.5	3	1.25	6	3 x 20
5001-65	63.5	48	6	3.3	1.35	6	3 x 20
5002-25	25.5	26.5	3.8	2.2	0.8	4	2.4 x 12
5002-32	32	32	4.4	2.4	1	4	2.4 x 16
5002-38	38	38	4.7	2.6	1.05	4	3 x 16
5002-50	50.5	48	5.5	3	1.25	6	3 x 20

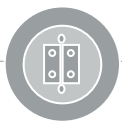

Coupling hinges

1201, 1205, 1206

Application

Coupling hinges for windows and French doors.
Journal-supported hinges for lighter hatches etc.

Material

- Zinc-plated steel
- Pin of brass

Features

- 1205, one half countersunk on the rear

Accessories

- According to the table

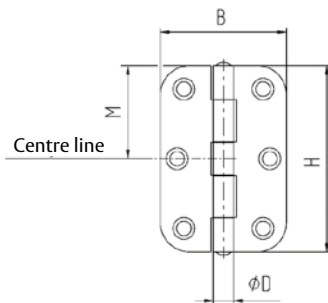

Ref. No.	Dimensions (mm)							Screw	
	H	B	D	G	M	Mill Ø	T	No.	Dim.
1201-65	63.5	36	6	0.7	32	20	1.35	6	3 × 20
1205	63.5	44	7	-	32	20	1.6	6	3.5 × 25
1206-65	63.5	44	7	1.2	32	20	1.6	6	3.5 × 25
1206-75	76	50	8	1.4	38	26	1.7	6	3.5 × 25

3881

Application

Coupling hardware for windows.

Features

- Right and left handed

Material

- Zinc-plated steel
- Pin of plastic

Accessories

- Screw 3.5 mm zinc coated

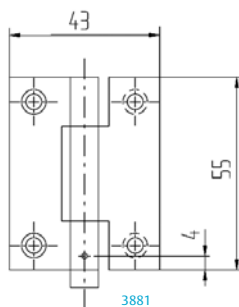

Snap-In hinges

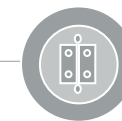

Hinges for light-weight interior doors

6540KS

Application

For light-weight interior doors.

Features

- Snap-In function
- Symmetrical right/left
- Also available in traditional style

Material

- Frame blade of steel, lacquered bronze or white

Accessories

- Recommended screws: three TFX 5 × 25

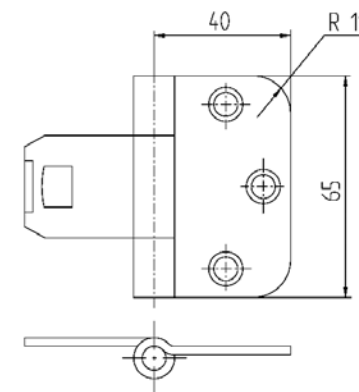

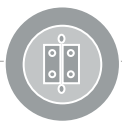

2403, 2434, 2465

Application
Door leaf for use together with frame blade 2465.

Material
• Nylon, bronze or white lacquered

Features
• Mortise dimensions depending on the type
• For door thickness 38 mm or 39 mm

Accessories
• Recommended screws: two TFX 5 x 25.

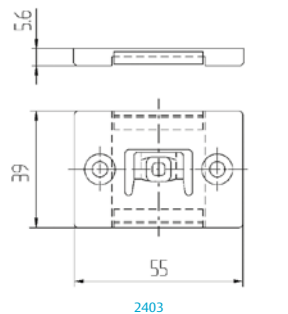

2403

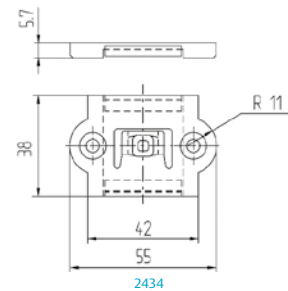

2434

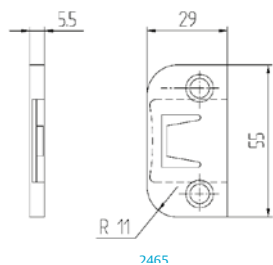

2465

2465 fire

Application
Door leaf for use together with frame blade 2465.

Material
• Steel, bronze or white lacquered

Features
• For fire doors

Accessories
• Recommended screws: two TFX 5 x 25

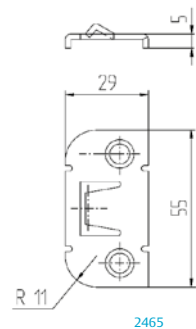

2465

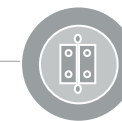

2419

Application
Door parts for use together with 2010 and frame blade 2465.

Material
• Nylon with steel plate

Finish
• Gold
• Silver
• White

Features
• For door thickness 38 mm or 39 mm

Accessories
• Recommended screw 2 pce TFX 5 x 25

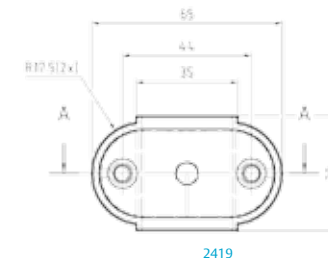

2419

2439, 2441, 2459

Application
Door leaf for use together with frame blade 2465.

Material
• Zinc, bronze or white lacquered

Features
• Different mortise dimensions depending on the type
• For door thickness 38 mm or 39 mm

Accessories
• Recommended screws: two TFX 5 x 25

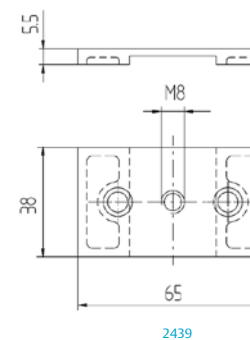

2439

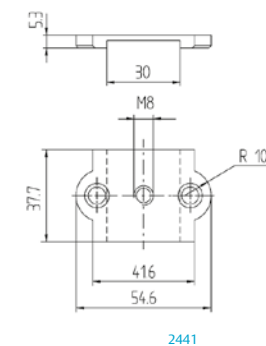

2441

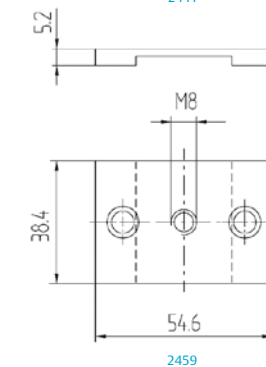

2459

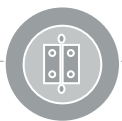

Spring hinges

279, 280

Application

For one- and two-way swing doors.
279 for automatically closing single-action doors.
280 for swing doors.

Material

- Steel, zinc-plated or nickel-plated

Features

- 279, one-way spring function, supported
- 280, two-way spring function, supported
- Adjustable spring power, regardless of right or left handedness
- Adjustable closing force

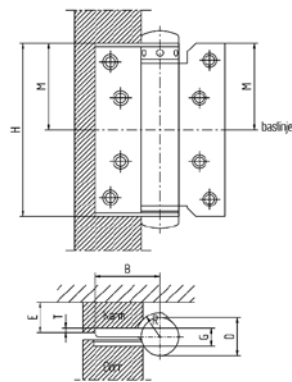

279

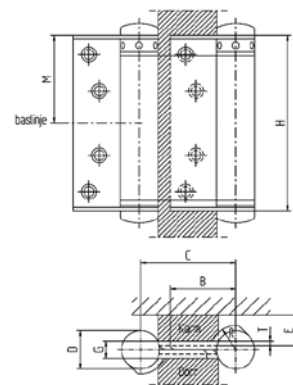

280

Ref. No.	Dimension (mm)									Screw		Max. door thickness
	H	B	C	D	E	M	G	R	T	No.	Dim.	
279-100	101	38	-	22	15	50.5	9	14	4	8	4×25	-
279-150	152	48	-	28	20	76	9	18	4	10	5×30	-
280-75	76	33	48	22	15	38	9	13.5	4	8	4×25	25
280-100	101	38	54.5	22	15	50.5	11	14	5	8	4×25	30
280-150	152	48	73.5	28	20	76	11	18	5	10	5×30	42

Spring hinges

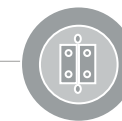

2220, 2228, 2248

Application

For unrebrated automatically closing doors.
2220 for lighter doors.

Material

- Zinc-plated steel

Features

- One-way, non-supported
- Right or left handed
- Adjustable spring power
- Adjustable closing force
- For closing function only use:
 - 2220 together with journal-supported hinges 3220
 - 2228 together with journal-supported hinges 3228 or 3278
 - 2248 together with journal-supported hinges 3248 or 3288

The hinges have the same fitting dimensions and can therefore be combined. The depth of the mortise is the same as for supported hinges. The hinges can be lifted off after the spring power has been released.

2466

Application

For single-action swing doors.
Together with hinges 2465.

Material

- Steel, lacquered

Features

- Single-action with adjustable spring power

Accessories

- Mounting plates. See symmetrical hinges

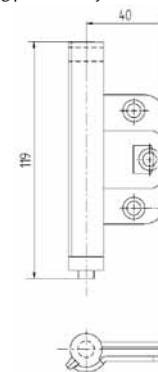

2466

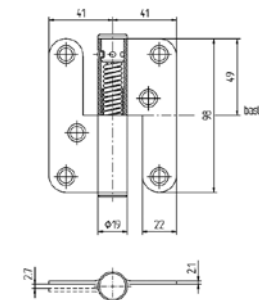

2220

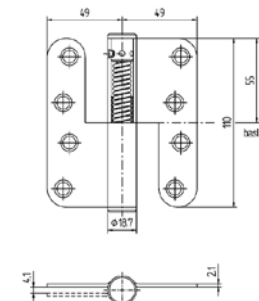

2228

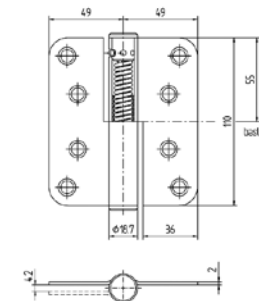

2248

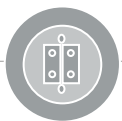

Accessories hinges

248

Application

Mounting plate for hinges in heavier doors.
Frame-reinforcing for security doors.

Material

- Steel

Features

- Right or left handed
- Hinges are fixed to the mounting plate with machine screw M6
- Four MFX 6 x 30 are used for frame
- Mounting on the outside of the frame
- 248-28 for hinges 3228, 3278, K1227
- 248-48 for hinges 3248, 3288

Accessories

- Recommended screws: two TFX 5 x 30

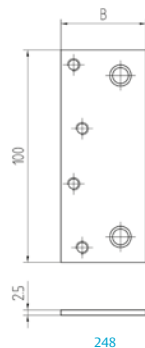

248

540

Application

Spare parts for ASSA ball bearing hinges.

Ref. No.	For pin Ø d	Dim. (mm) D	Dim. (mm) T
540-9.25	9.25	18	7.5
540-12	12	24	8

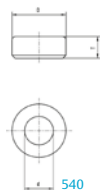

540

249

Application

Adjustment disc for height adjustment of doors
with journal-supported lift-off hinges.

Material

- Steel, hardened and zinc-plated

Ref. No.	Dim. (mm) D	Dim. (mm) T
249-7 x 1	7	1
249-7 x 1.5	7	1.5
249-8,5 x 1	8.5	1
249-8,5 x 1.5	8.5	1.5

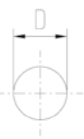

249

2301

Application

Security pins of hardened steel for screwing through
hinges into the frame. For hinges with holes for
security pins.

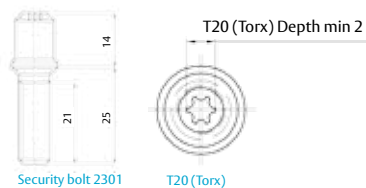

Security bolt 2301

T20 (Torx)

2302

Application

Screw for adjusting the width of door chink. For
screwing into the frame behind the hinge leaf of
hinges that can be horizontally adjusted.
Allen key 3 mm.

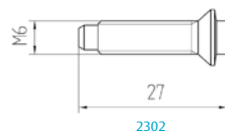

2302

Flush bolt

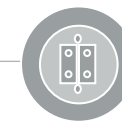

96

Application

Flush bolt for double doors.

Material

- Zinc-plated steel

Features

- With pivot arm and robust design
- Material of steel for fire-rated doors
- Also available with rounded plate corners

Accessories

- Recommended screws: three TFX 4 x 45 and two TFX 3 x 20

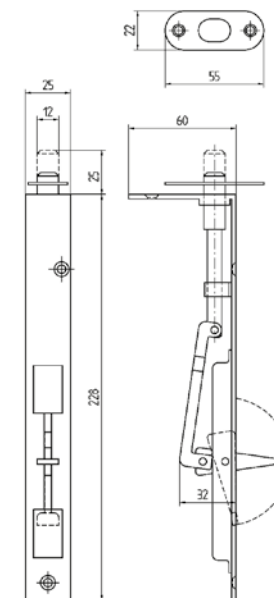

96

97

Application

Flush bolt for double doors and windows.

Material

- Zinc alloy with bolt of steel
- Strike plate of propene plastic

Features

- The bolt is operated by the pivot arm and is easy to install.

Accessories

- Recommended screws: two TFX 3.5 x 25

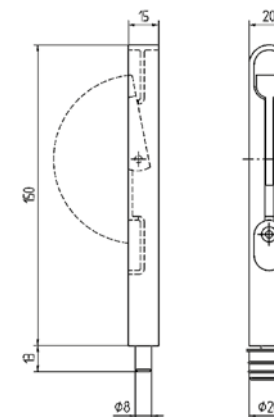

97

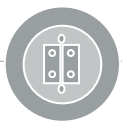

Flush bolt

1296, 1396

Application

Flush bolt, manual, for the passive door leaf in wooden, steel or aluminium double doors.

Features

- Manual single-action
- Bolt Ø 12 mm with 25 mm throw. Material of steel for fire-rated doors
- Door preparation for flush bolt 1296, 1396 and 2396 is the same
- Face plate width 22 mm
- Dimension from the face plate to the centre of the bolt is adjustable 30-36 mm
- Finish: Bright zinc-plated

Function

- The bolt is operated by the pivot arm.

Accessories

- Strike plate
- Guide, for use in wooden doors when climate changes may affect its features, and in doors with profiles of various materials.

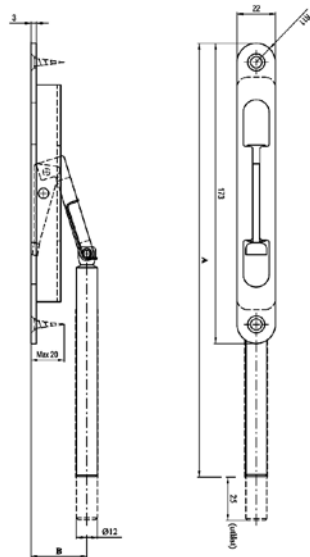

1296

2396

Application

Flush bolt, automatic, for the passive door leaf in wooden, steel or aluminium double doors.

Features

- Automatic single-action
- Bolt Ø 12 mm and with a min 17 mm throw, adjustable +10 mm
- The latch is reversible
- Material of steel for fire-rated doors
- Door preparation for flush bolt 1296, 1396 and 2396 is the same
- Face plate width 22 mm
- Dimension from the face plate to the centre of the bolt is adjustable 30-36 mm
- Finish: Bright zinc-plated

Function

- The bolt is operated by the latch bolt.

Accessories

- Strike plate
- Guide, for use in wooden doors when climate changes may affect its features, and in doors with profiles of various materials.

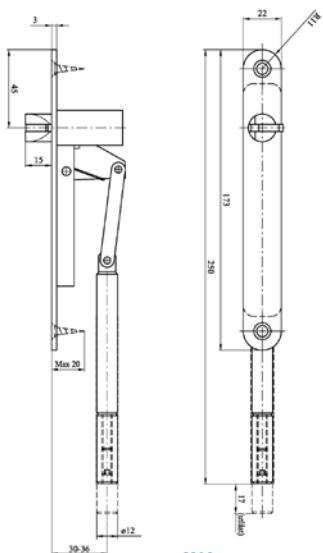

2396

Denominations for hinges

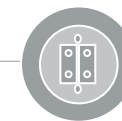

ADDITIONAL DENOMINATIONS	
CRANK (mm)	Non-standard cranking in mm (2 mm) (CRANK 3.2)
SSP	Hinges with stainless steel pin (Stainless Steel Pin)
SS	Hinges of stainless steel (Stainless Steel)
SS4	Hinges of acid-proof stainless steel (Stainless Steel acid proof)
K	Hinges with supporting ball-bearing in the knuckle
FOP	Hinges that allow the door to open outside the frame opening of 90° (Free Opening Performance)
BU	Hinges with plastic bush in the knuckle (Bushing)
SHO (mm)	Shortened length of rolling in mm compared to standard hinge (Shortened)
EXT (mm)	Extended length of rolling in mm compared to standard hinge (Extended)
CLIP (mm)	Cut blade on standard hinge (Cut length in mm)
TR	Trend style
OF	Old fashion style
AM	"Allmoge" (Old Swedish style)
WE	Weld reinforced (Welded)
Frame blade/Door leaf	
	Standard
01	Height adjustment
02	Side adjustment
03	Deflected
04	Side adjustment, height adjustment
05	Riveted security bolt, height adjustment
06	Riveted security bolt
07	Riveted security bolt, height adjustment, side adjustment
08	Security bolt
09	Side adjustment, security bolt, height adjustment
10	Side adjustment, security bolt, height adjustment and deflected
11	Height adjustment, deflected
12	Height adjustment, security bolt
13	Side adjustment, security bolt
14	Side adjustment, deflected
15	Security bolt, deflected
16	
17	
18	Oval hole for security bolt, hole for height adjustment washer
19	Round hole for security bolt, hole for height adjustment washer
20	Standard without hole for height adjustment washer
21	Oval hole for security bolt without hole for height adjustment washer
22	Round hole for security bolt without hole for height adjustment washer
23	Round hole for security bolt with extra screw hole, hole for height adjustment washer
24	Round hole for security bolt with extra screw hole, without hole for height adjustment washer
25	Extra attachment hole, door leaf

N.B. Deviations can occur!

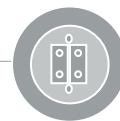
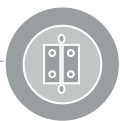

ADDITIONAL DENOMINATIONS		
Denomination of complete hinge = Door leaf denomination		
12..		Lift off hinges
20..		Snap In
22..		Spring hinges
32..		Pin bearing on one pin (One pin)
62..		Pin bearing (Two pin) (Snap in type)
30..		Pin bearing (One pin) Symmetric
60..		Pin bearing (Two pin) Symmetric (Snap in type)
.. 1 .	3 rd digit	Winslot. 4 th digit = slot standard. Please contact ASSA for advice.
.. 2 .	3 rd digit	Asymmetrical mill out 3.1 mm material
.. 4 .	3 rd digit	Symmetrical mill out 3.1 mm material
.. 7 .	3 rd digit	Asymmetrical mill out 3.7 mm material
.. 8 .	3 rd digit	Symmetrical mill out 3.7 mm material
3240 - length of rolling		
		Mortice hinge with height adjustment 3.1 mm material
3241 - length of rolling		
		Mortice hinge 3.1 mm material
3270 - length of rolling		
		Mortice hinge with height adjustment 3.7 mm material
3271 - length of rolling		
		Mortice hinge 3.7 mm material

N.B. Deviations can occur!

* Length of rolling = from rear edge to the centre knuckle

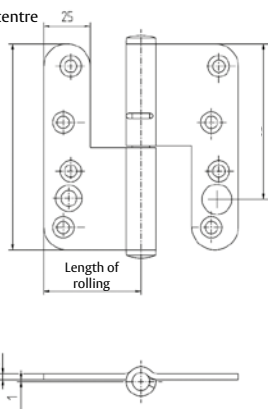

The serial number principle has previously been used for the denomination of hinges. The numbers have therefore not had the same significance in all the hinge ranges.

Now ASSA has created a symbiosis between all types of hinges in which the significance of the numbers is more detailed.

CONVERSION TABLE HINGES					
Frame		Door		Complete hinges	
Old denomination	New denomination	Old denomination	New denomination	Old denomination	New denomination
3228 frame	3228-	3228 door	3228-	3228	3228
01	03				
02	AM			3228-02	3228 AM
03	01				
		06	CLIP 34		
		07	CLIP 29,8		
08	08	08	18	3228-08	3228-08
08 Allmoge	08 AM	08 Allmoge	19 AM	3228-08 Allmoge	3228-08 AM
09	13				
12	08	12	19	3228-12	3228-08/19
20	SHO 7	20	SHO 7	3228-20	3228 SHO 7
21	03 SHO 7	21	SHO 7		
22	EXT 22		EXT 22		
25	FOP	25	FOP		
26					
30	SS	30	SS		
31	SSP	31	SSP		
40	CRANK 3,2	40	CRANK 3,2		
		41	CLIP 29,8 CRANK 3,2		
3220 frame	3220-	3220 door	3220-	3220	3220
02	AM	02	AM	02	AM
03	CLIP 41	03	CLIP 41	03	CLIP 41
40	CRANK 3,2	40	CRANK 3,2	40	CRANK 3,2
6248 frame	6248-	6248 door	6248-	6248	6248
09	09	01	01	09	09
10	10	01	01	10	10
9 CRANK 4	9 CRANK 4	01	01	9 CRANK 4	9 CRANK 4
10 CRANK 4	10 CRANK 4	01	01	10 CRANK 4	10 CRANK 4
3244 frame	3244-	3244 door	3244-	3244	3244
02	AM	02	AM	02	AM
08	08	08	19	08	08
3248 frame	3248-	3248 door	3248-	3248	3248
02	AM	02	AM	3248-02	3248-AM
04	CLIP 3,5	04	CLIP 3,5		
05	05	05	22	3248-05	3248-05
06	06	06	19	3248-06	3248-06
08	08	08	19	3248-08	3248-08
08 Allmoge	08 AM	08 Allmoge	19 AM	3248-08 Allmoge	3248-08 AM

N.B. Deviations can occur!

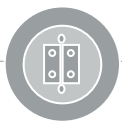

CONVERSION TABLE HINGES					
Frame		Door		Complete hinges	
Old denomination	New denomination	Old denomination	New denomination	Old denomination	New denomination
3248 frame	3248-	3248 door	3248-	3248	3248
09	13	09	22	3248-09	3248-13
12	CRANK 4	12	CRANK 4	3248-12	CRANK 4
30	SS4	30	SS4	3248-30	SS4
31	SSP	31	SSP	3248-31	SSP
3278 frame	3278-	3278 door	3278-	3278	3278
03	04	03	20	3278-03	3278-04
08	08	08	18	3278-08	3278-08
09	12	09	18	3278-09	3278-12
3288	3288	3288	3288	3288	3288
06	02	06	Standard	3288-06	3288-02
07	13	07	21	3288-07	3288-13
08	08	08	18	3288-08	3288-08
09	09	09	22	3288-09	3288-09
10	10	10	22	3288-10	3288-10
11	03	11	Standard	3288-11	3288-03
40	10 CRANK 3,2	40	22 CRANK 3,2	3288-40	3288-10 CRANK 3,2
3225 frame	3225-	3225 door	3225-	3225	3225
04	08	04	-25	3225-04	3225-08
41	08 EXT3	41/51	-25 EXT3	3225-41	3225-08 EXT3
51	12 EXT3	41/51	-25 EXT3	3225-51	3225-12 EXT3
47	3275-08 EXT3	47/57	3275-25 EXT3		se 3275
57	3275-12EXT3	47/57	3275-25EXT3		se 3275
3275	3275	3275	3275	3275	3275
	3275-08 EXT3		3275-25 EXT3		3275-08 EXT3
	3275-12 EXT3		3275-25 EXT3		3275-12 EXT3
3240	3240				
3240	-45				
-01	-42,5				
-02	-48				
-32	-48SS				
-41	-46				
-51	-52				
-47	3270-46				
-57	3270-52				

N.B. Deviations can occur!

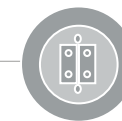

CONVERSION TABLE HINGES					
Frame		Door		Complete hinges	
Old denomination	New denomination	Old denomination	New denomination	Old denomination	New denomination
3241	3241				
-04	-46				
-05	-49				
-41	-46				
-51	-52				
-47	3271-46				
-57	3271-52				
3270	3270				
	3270-46				
	3270-52				
3271	3271				
	3271-46				
	3271-52				

N.B. Deviations can occur!



WINDOWS AND PATIO DOORS

This section presents a selection of the ASSA range of fittings. Multi-point locks, lockable handles, code handles, window locks and other security locks are represented.





Multi-point door lock

Multi-point door lock

Used for outward- and inward-opening front doors.

M5600

The M5600 is lockable and has a Euro-profile cylinder. Faceplate 25 x 2 mm. Galvanized. Backset 55 mm, locking depth 72 mm. Deadbolts, latch bolt and two hook bolts. The hook bolts provide increased protection against forced entry. Length 2050 mm. Handle height 1070 mm. Available in right and left versions.

M5602

Like the ASSA M5600, but made to measure.

M5601

Made to measure, outer bolts, wedge bolt type. Otherwise like the ASSA M5600.

Operation and features

When the door is unlocked, the hook/wedge bolts and deadbolt are retracted. The latch bolt is engaged and keeps the door in place and closed. The handle, which is horizontal, is pushed down to open the door. The door can be closed without turning the handle. Locking is done by turning the handle up. The handle returns to a horizontal position. The locking is then done with a key or turn catch. The deadbolt is then engaged and interlocked with the hook/wedge bolts.

Accessories

Receivers

Handle (without return spring) and DIN-standard-type turn catch

Lock cylinder: Euro-profile cylinder

When ordering the M5602 or the M5601, please state:

1. Item number
2. Length
3. Handle height
4. Type of receiver
5. Number of bolts, type and placing
6. Right or left

Multi-point door lock



Lock case

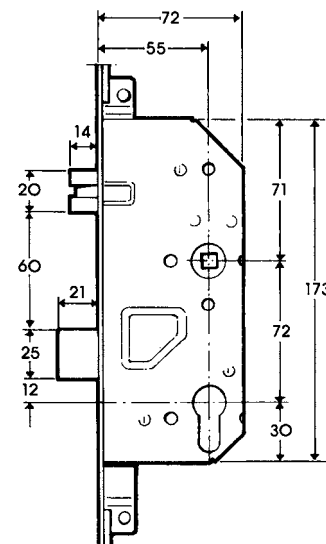

M5600

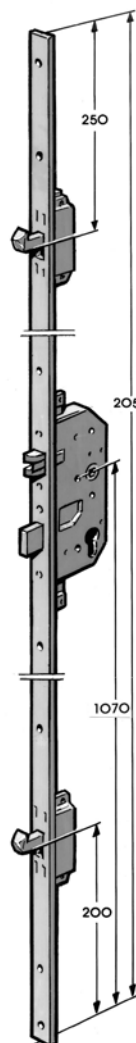

M5601

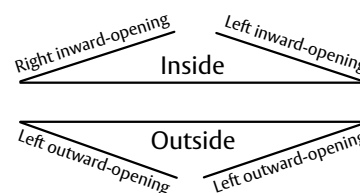



Multi-point door lock

Multi-point door lock

Used for outward- and inward-opening front doors, primarily PVC doors.

M5700

The M5700 is lockable and has a Euro-profile cylinder. Face plate 16 mm. Galvanized. Backset 35 mm, locking depth 52 mm. Deadbolt, latch bolt and two hook bolts. The hook bolts provide increased protection against forced entry. Length 2,050 mm. Handle height 1,070 mm. Available in right and left versions. Can be changed by rotating the latch bolt.

M5703

Made to measure. Face plate 16, 20, 22 or 25 x 2 mm. Otherwise like ASSA M5700.

Backset	Lock depth
35 mm	52 mm
45 mm	62 mm
55 mm	72 mm

M5701

Made to measure. Outer bolts, wedge-bolt type. Otherwise like ASSA M5700.

Operation and features

Standard-action interior and exterior handles are mounted into the top row.

Locking:

1. Lift the handle. The hook bolts and the hook dead-bolt are operated and enter the receivers.
2. Press the handle to retract all bolts, including the latch bolt. When the door is unlocked, the latch bolt keeps it closed. The latch bolt is retracted when the handle is pressed.

"Slam-shut" - operation

(Does not apply to 28 mm backset). The inside handle is mounted into the top row. The outside handle is mounted into the bottom row.

Locking: as above.

Unlocking: as above, but with the difference that from the outside the latch bolt can only be retracted by using a key. From the inside, the latch bolt is retracted when the handle is pressed.

Accessories

Receivers

Handle (without return spring) and turn catch of DIN-standard-type

Lock cylinder: Euro-profile cylinder

Multi-point door lock



Lock case

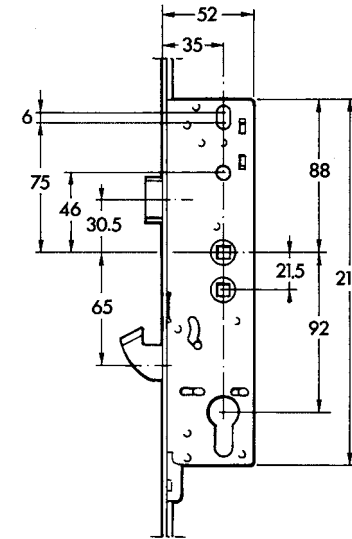

M5700

M5701

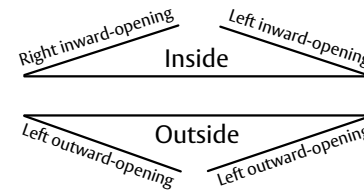
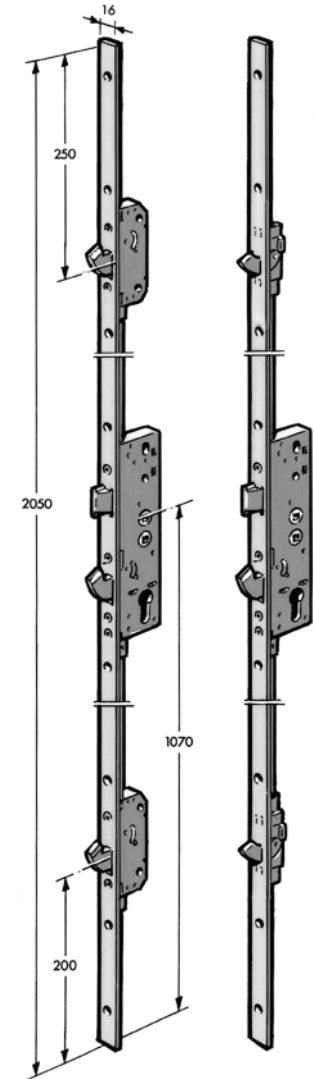



Vinga window and patio door handle

ASSA 7311

The ASSA 7311 is a handle for both older and newer architecture. It is available in straight, right and left versions.

Operation

ASSA 7311 has a cover plate for hidden-screw mounting. The handle is pressed into the plate with a unique snap-in mounting. The grip is easily loosened and replaced with a different grip - a lockable grip, for example - or a grip with a different surface treatment.

Material

The handle and cover plate: chrome-plated, satin chrome or brass zamak plating. (Epoxy powder paint and prion are available on request). The square 8-mm spindle is made of galvanized steel. The handle can be delivered with 7 mm square as a special order. Epoxy powder paint is recommended to enhance the corrosion protection of the outside handle. Spindle length: 33, 43, 53 mm.

Accessories

Handle locking device ASSA 7450.
Handle coupling.



7311 V

7311

7311 H

Patent/registered design

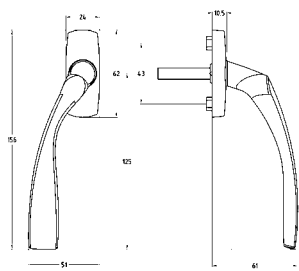

7311 V

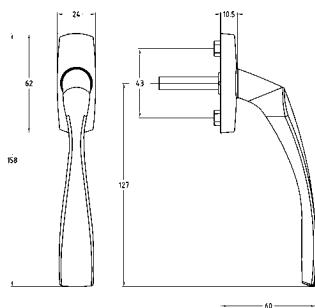

7311

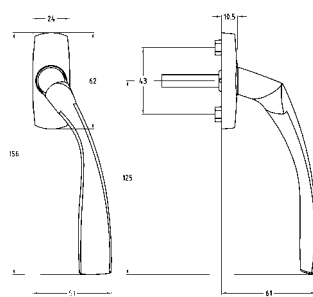

7311 H



Vinga window handle

ASSA 7343

The ASSA 7343 handle is suitable for both older and newer architecture. The handle is available in straight, right and left versions. It is meant for smaller windows.

Operation

The ASSA 7343 has a cover plate to permit hidden-screw mounting. The handle is pressed into the plate with a unique snap-in mounting. The grip can easily be loosened and replaced with a different grip - a lockable grip, for example - or a grip with a different surface treatment.

Material

Handle and cover plate: chrome-plated, satin chrome or brass zamak plating. (Epoxy powder paint and prion are available on request). The square 8-mm spindle is made of galvanized steel. The handle may be delivered with 7 mm square as a special order. Epoxy powder paint is recommended to increase the corrosion protection of the outside handle. Spindle length: 33, 43, 53 mm.

Accessories

ASSA 7450 handle-locking device. Handle coupling.



7343 V

7343

7343 H

Patent/registered design

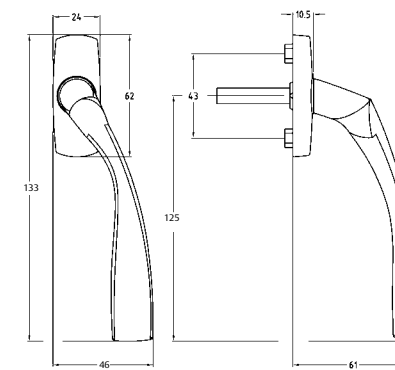

7343 H



Vinga window and patio door security handle



7312 V

7312

7312 H

Patent/registered design

ASSA 7312

The ASSA 7312 is a lockable handle that is suitable for both older and newer architecture. It is available in straight, right and left versions.

Operation

The ASSA 7312 has a cover plate to permit hidden-screw mounting and the screws are blocked when the handle is in a locked position. The handle is pressed into the plate through a unique snap-in mounting. The grip is easily loosened and replaced with a different grip - a non-lockable grip, for example - or a grip with a different surface treatment.

Material

Handle and cover plate: chrome-plated, satin chrome or brass zamak plating. (Epoxy powder paint and prion are available on request). The square 8-mm spindle is made of galvanized steel. The handle can be delivered with 7 mm square as a special order. Epoxy powder paint is recommended to increase the corrosion protection of the outside handle. Spindle length: 53 mm

Accessories

Cylinder
Handle coupling

Note

Approved compliance with SS 3620, class B.

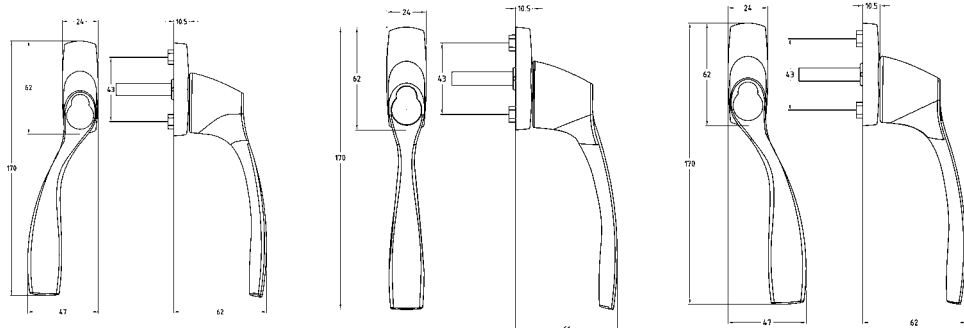

7312 V

7312

7312 H



Vinga cylinders for the Vinga 7312 handle

Vinga cylinders for the Vinga 7312 handle

Used for the Vinga 7312 handle.

ASSA 716

The ASSA 716 is part of the ASSA Max solution, which is designed for the DIY market.

ASSA 5816

ASSA 5816 cylinders are used in lock systems. ASSA 716/5816 cylinders can be ordered from ASSA AB.

Vinga 7310

The Vinga 7310 cylinder offers the user keyed-alike or different locking. It can be ordered from ASSA OEM AB.

Operation

All cylinders are of the pushbutton cylinder type, meaning that locking involves the cylinder being pushed into the handle. Unlocking involves the cylinder returning to the unlocked position. The key can be removed in both the locked and the unlocked positions.

Material

Chrome-plated, satin chrome, brass-plated, prion satin brushed brass or brown oxidation.

Installation

Includes spring pin for easy mounting/dismounting in the Vinga handle.

Note

Meets the requirements for lockable windows and patio doors under the Swedish Standard SS 3620, class B.



ASSA 716



ASSA 2416



ASSA 5816



Vinga 7310

Article No.	Series
716	Vinga cylinder, 700 series
2416	Vinga cylinder, dp CLIQ series
5616	Vinga cylinder, Max series
4816	Vinga cylinder, 4800 series
5816	Vinga cylinder, 5800 series
7310	Vinga cylinder



7810, Bright chrome, right



7810, White, right

ASSA Code Handle

Application

- For windows and terrace/balcony doors to be locked from inside
- The product is patented
- The simplicity enhances security

Feature

- Meets mechanical requirements according to standards SS3620, class B*
- Lock with button and unlock with personal code
- Simple installation, no cables
- To be fitted with one way screws (security screws)
- Enhanced child security

Function

- The Code Handle is unlocked with a 6 digit code to be based on numbers 1 to 4
- Separate lock button
- The code is not affected by voltage drop/battery change
- The code can be changed an unlimited number of times
- Operated by two replaceable CR2 lithium batteries (included with product)
- Battery lifetime is approximately 60.000 operations during normal operating conditions
- Indication of low batteries

* The current standard only covers tests with mechanical keys. Consequently, a certificate from SBSC can not be obtained. The product is tested and fulfills the requirements regarding applicable areas.



7811, Satin chrome, long plate, left



Model	Description	Executions
7810	Short plate (normal)	Right or left
7811	Long plate	Right or left
7801	Non coded*, Short plate (normal)	Right or left
7802	Non coded*, Long plate (normal)	Right or left

Available in satin chrome, bright chrome or white. The product has an 8 mm square spindle, 53 mm length (also available in 100mm length and/or 7 mm square spindle).

* Non coded versions can be used for double doors.

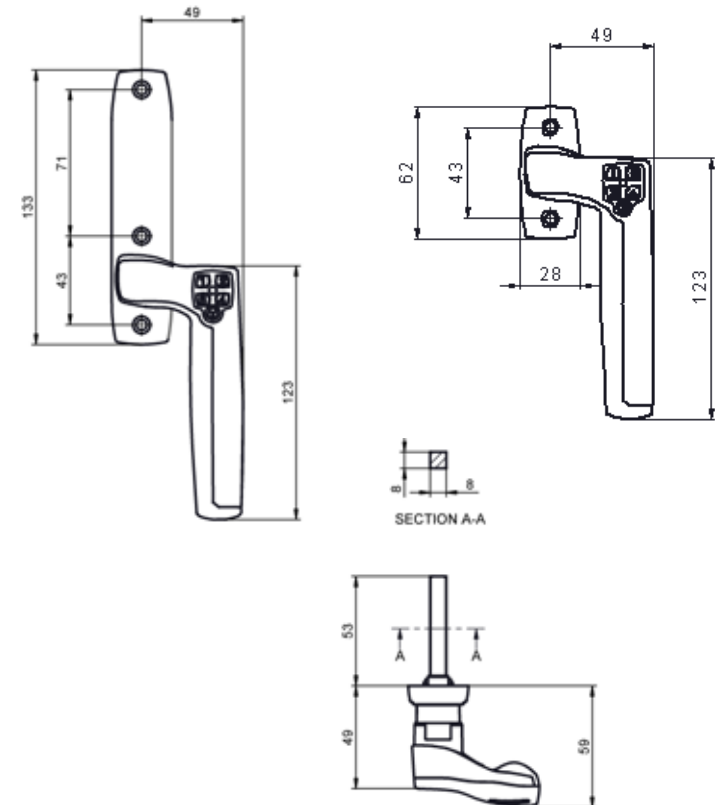

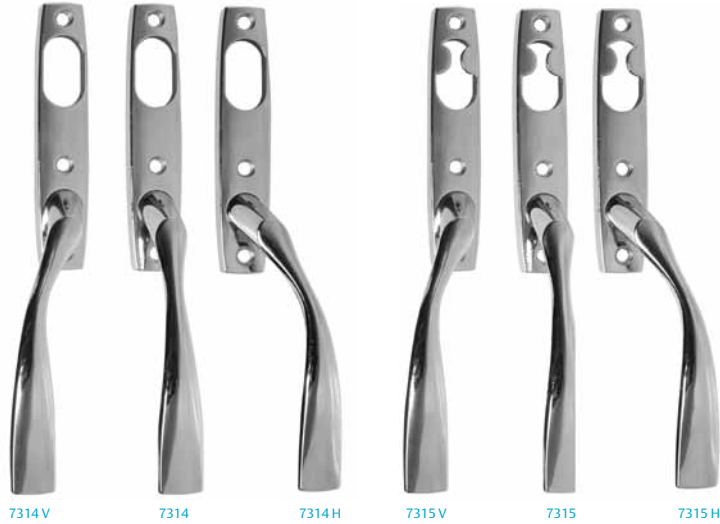

Registered design

Vinga 7314 and 7315

The Vinga 7314 and 7315 handles are both suitable for older and newer architecture. The size and design of the handle make it easy to operate even old and large doors.

Operation

The Vinga 7314 has an oval slot in the back plate. The Vinga 7315 has a rococo slot in the back plate. Both handles fit ASSA lockable espagnolettes and are locking from one or both sides with a cylinder and/or a turn catch.

Material

Handle and back plate: chrome-plated, satin chrome or brass zamak plating. (Epoxy powder paint and prion are available on request.) The square 8-mm spindle is made of galvanized steel. The handle may be delivered with 7 mm square as a special order. (Epoxy powder paint is recommended to increase the corrosion protection of the outdoor handle.) Spindle length: 53 mm.

Accessories

- Vinga 7313 turn catches
- Vinga 7335 turn catches

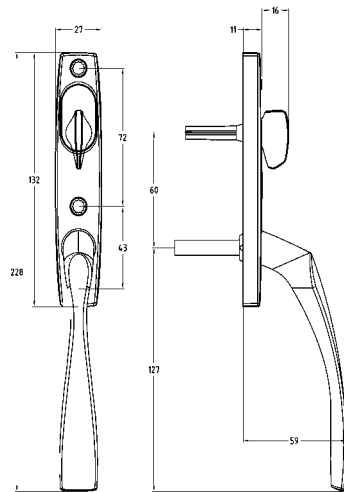

7314



Mounting examples of lockable espagnolettes combined with Vinga ASSA 7314D/7315D handle kits suitable for spindles with brake slots (item No. CB90) for single sash.

Cover plate outside, turn catch inside

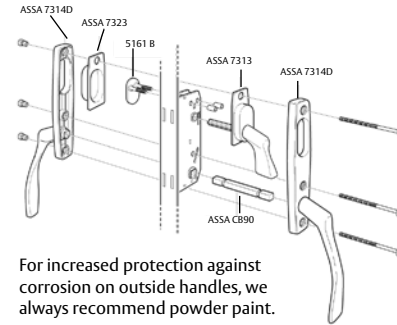

For increased protection against corrosion on outside handles, we always recommend powder paint.

Cylinder both sides

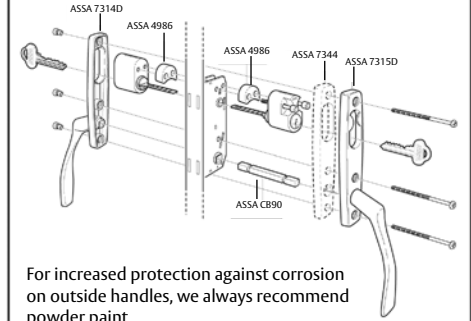

For increased protection against corrosion on outside handles, we always recommend powder paint.

Cover plate outside, cylinder inside

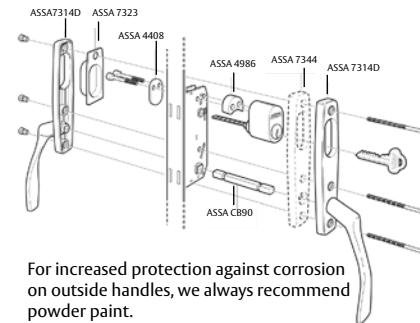

For increased protection against corrosion on outside handles, we always recommend powder paint.

Cylinder outside, turn catch inside

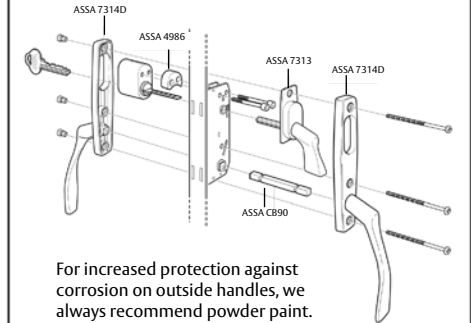

For increased protection against corrosion on outside handles, we always recommend powder paint.

Fixing plate outside, cylinder inside

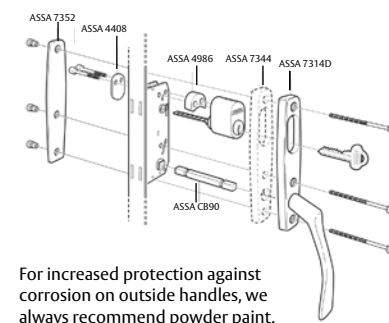

For increased protection against corrosion on outside handles, we always recommend powder paint.

Door thickness

Spindle

49-54	CB90	0800
54-59	CB90	0850
59-64	CB90	0900
64-69	CB90	0950
69-74	CB90	1000
74-79	CB90	1050
79-84	CB90	1100
84-89	CB90	1150
89-94	CB90	1200
94-99	CB90	1250

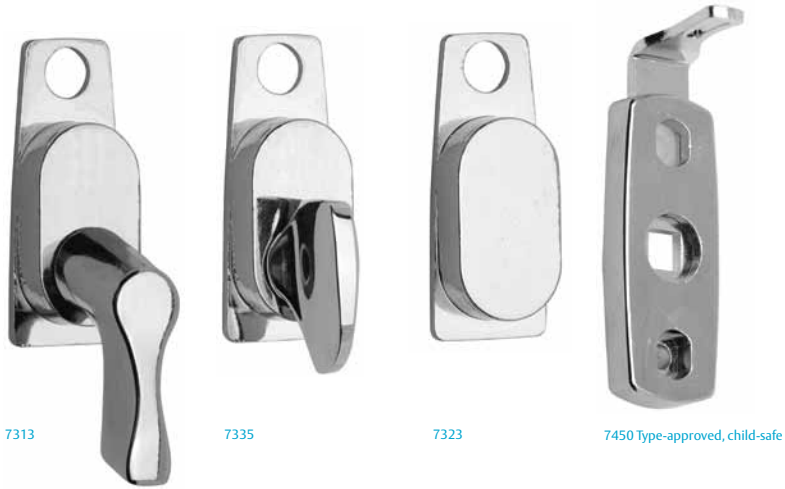

Vinga 7313 and 7335

The Vinga 7313 and 7335 turn catches fit the inside of the Vinga 7314 handle.

Vinga 7335

The Vinga 7335 is specially adapted for the insides of the ASSA S307 and ASSA 4107 latch bolt espagnolettes.

Vinga 7323

The Vinga 7323 cover plate fits the outside of the Vinga 7314 handle.

Operation

The turn catch is pressed from behind into the back plate of the Vinga 7314 handle. The espagnolette is locked when the handle is in a vertical position and unlocked when it is in a horizontal position. The cover plate is pressed from behind into the back plate of the Vinga 7314 handle and used when an outside cylinder is not needed.

Material

Chrome-plated, satin chrome or powder paint coating zamak.

Vinga 7450

The Vinga 7450 handle-locking device is used for windows and patio doors.

Operation

The Vinga 7450 locks automatically when the handle is turned to locked position. For opening, the catch must be lifted and the handle turned at the same time.

Material

Housing: chrome-plated, satin chrome or brass zamak plating. (Epoxy powder paint and prion are available as special order.) Catch arm: galvanized steel.

Installation

In combination with Vinga 7311, 7343.

Note

Type-approved, child-safe.

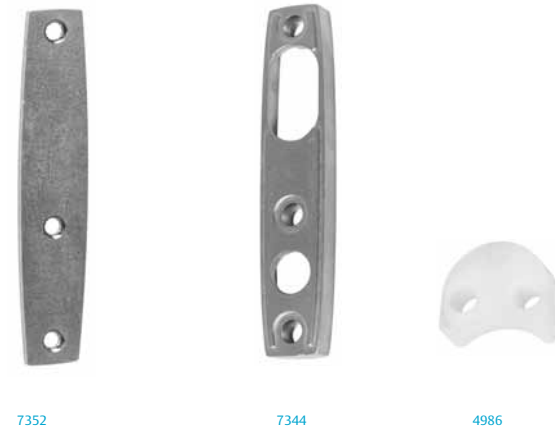

Vinga 7352 fixing plate

Used for single sash or coupled sash where only the Vinga 7314 or the Vinga 7315 handle is used on the inside.

Material

Chrome plated or white powder paint coated steel.

Vinga 7344 spacer plate

Used as a pad for the Vinga 7344 and Vinga 7315 handles when the cylinder sticks out too far.

Construction

The plate is 10 mm and can be stacked.

Material

The plate is made of zamak. Polished chrome, satin chrome, brass-plated (powder paint and prion are available on request).

Vinga 4986 spacer device

Used for cylinder in the Vinga series.



2820



2830



ASSA 2820 and 2830

Used on windows that must be secured against forced entry and unauthorized opening. Approved compliance with SS 3620 class A. Lockable using the ASSA 7287 cylinder or the ABLOY pushbutton cylinder.

Operation and features

Locking requires that the cylinder be pushed down while the window is in a closed position. The ASSA 2820 and the ASSA 2830 can also be locked in an airing position (not approved as compliant with the locking requirements of SS 3620). When the key is turned, the cylinder springs up and opens the lock. The key can be removed when unlocked. The window lock is available with the same locking as the security handles ASSA 844S, 876S, 895S and 8465S.

Material

Cylinder housing, frame fixture: zamak, chrome-plated, satin chrome, brass plated or powder painted white. There is a ventilation arm made of galvanized steel.

Screw

Use screw No. 8 (4.0 mm) TFX/DIN 7997.

Installation

Mounting instructions are included in the package.

When ordering, please specify:

1. Desired surface treatment
2. Type of cylinder

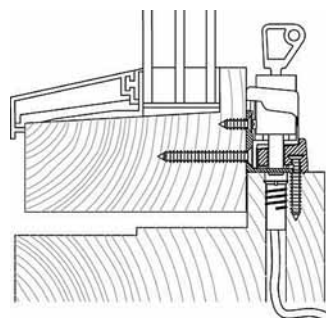

2830E, where indications for closed and for locked versus unlocked are required.



2820

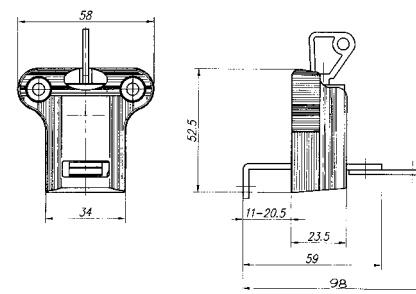

2830

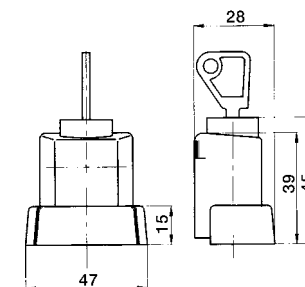

Mounting example 2820

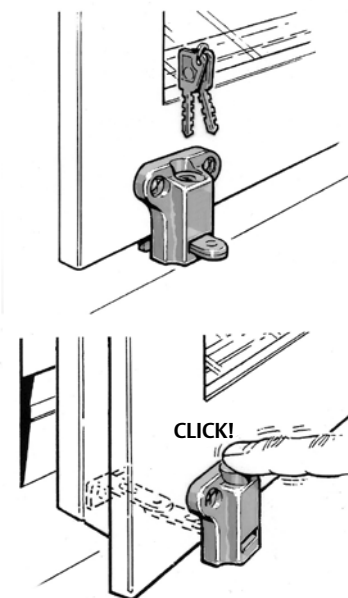

Mounting example 2830

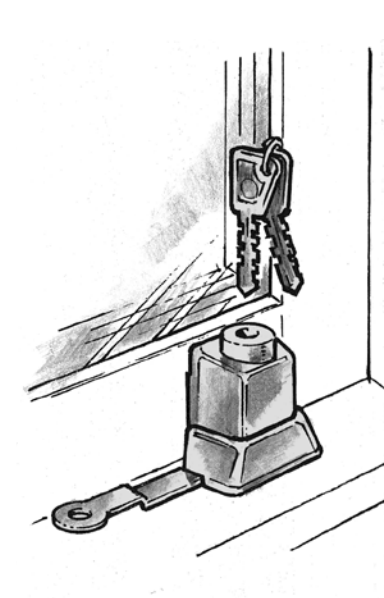



Pushbutton cylinders for window locks



7287

7287 pushbutton cylinder

Cylinder with 9 discs, for ASSA 2820 and 2830. Available with the same locking as the ASSA 4484 pushbutton cylinder intended for the ASSA 844S, 8765, 895S and 8465S security handles. Each cylinder comes with two ASSA 5525 keys.

ABLOY pushbutton cylinder

(Order from ASSA).
Cylinder with 11 discs, for ASSA 2820 and 2830 window locks. Available with the same locking mechanism as the pushbutton cylinder intended for the ASSA 844S, 8765, 895S and 8465S security handles. Also available as locking system. Each cylinder comes with two keys.



ABLOY pushbutton cylinder

Material

The cylinders are made of nickel-plated brass and the keys of nickel-plated steel.

Installation

The cylinders are delivered separately for mounting according to the instructions included with the window lock.

When ordering, please state:

- The locking number, or whether keyed-alike or different locking is desired.
For the system version of the ABLOY pushbutton cylinder, please state:
1. Quantity of each lock.
 2. New system or supplementation of an existing system.
 3. The number of keys required for each lock, and the number of master keys required.

Security device, triangular handle

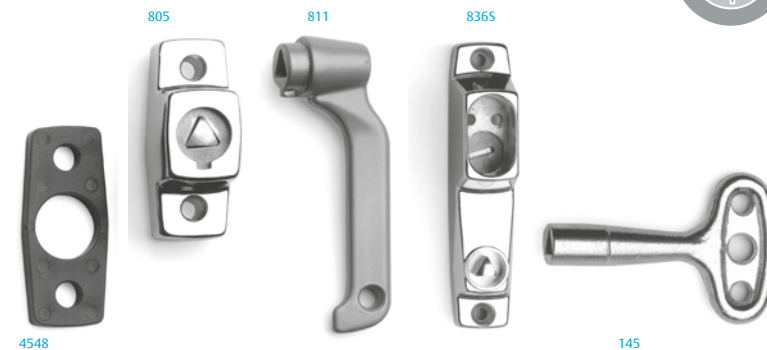

4548

Spacer plate 4548

Used when mounting is done without drilling for the security device hub.

Material

Grey acetal plastic.

ASSA 805

The ASSA 805 security device. Type-approved as a child-safe security fitting. Used instead of a handle on windows, patio doors and cupboard doors with an espagnolette, where protecting children from unauthorized opening of doors and windows - such as staircases, corridors, hospitals, nurseries, etc. - is paramount.

Operation and features

A spring-loaded catch plate lies around the triangular pin. It must be pushed into a certain position to allow the spindle to be turned and the espagnolette to be activated.

Material

The catch housing is made of chrome-plated zamak. The spindle and catch plate are made of tempered, galvanized steel.

Spindle length

23, 33, 43. (Note: Tempered-steel spindles are difficult to cut).

Installation

Mounted with enclosed one-way screws.

Accessories

ASSA 811 triangular handle and ASSA 4548 spacer plate.

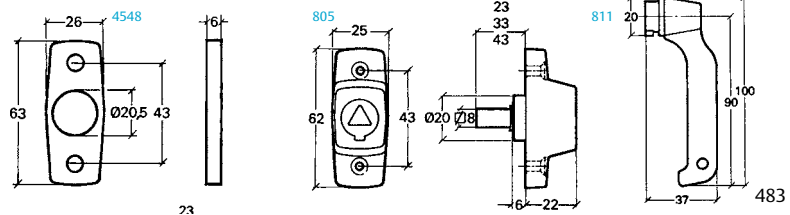

ASSA 811

The ASSA 811 triangular handle. Used for operation of ASSA 805.

Operation and features

When the handle is turned, the sash can be pulled with the handle. It can only be taken out in closed position.

Material

Chrome-plated zamak.

Security device 836S (self-locking)

Compliant with SS 3620 class B. Used for the inside of windows, patio doors and cupboard doors with an espagnolette, where a fixed handle is not desired. Needs to be secured against forced entry or unauthorized opening. Lockable using a cylinder.

Accessories

Standard-type oval cylinder
ASSA 145 triangular key
ASSA 841S mounting plate

Spindle lengths

33, 43, 53 mm.
Otherwise like ASSA 837S.

Triangular key 145

For operation of espagnolettes using a ASSA 56 triangular pin, see below.

Material

Aluminium.



LEVER LOCKS

ASSA OEM AB manufactures and markets security solutions based on lever technology for homes, properties and storage units for valuables. Our main emphasis is on approved security products that discerning customers see as the best possible choice.

ASSA OEM AB
Box 371
SE-631 05 Eskilstuna
Sweden
Phone: +46 (0)16 17 70 00
www.assaoem.se





Door and window locks



ASSA 910-35 Connect, 910-50 Connect, 911-35 Connect, 911-50 Connect

Application

ASSA 910/911 Connect is an extra lock/mortise for doors in private houses, commercial buildings, and areas with extra high demand for burglary resistance. The lock cases are available in two backsets; 35 and 50 with or without latch bolt. The locks are also available with micro switch indication for use in combination with alarm systems or for similar purposes.

Features/function

- The locks are designed with 9 brass levers
- 360 degree turn with automatic interlocking mechanism
- 24 mm throw of hook bolt
- Hardened hook bolt
- Self blocking function when exceeding the resistance of the hook bolt
- When locked, a key is required to open the lock from either side
- The locks meet the requirements of EN 12209, grade 5
- Zinc-plated lock case
- Delivered with 3 keys as standard

Flexible and user friendly

ASSA Connect can easily be assembled key alike with the traditional ASSA lever lock range. The new smoother design of the key makes it more user friendly and ergonomic. The lock meets the requirements of EN 12209 grade 5.

Standard design

- Lock of galvanised steel
- Supplied with 3 brass keys, total length 80 mm
- Brass lever
- Hardened hook bolt that hampers attempts at sawing through the lock

Backset (mm):	35	50	70
Mortise depth (mm):	49	64	84

Special design

- Key Alike can be ordered on demand
- Micro switch indication
- Hardened steel keys. Available in 68 mm, 80 mm, 90 mm and 125 mm lengths

Dimension drawing

910 with lever handle function
911 without lever handle function

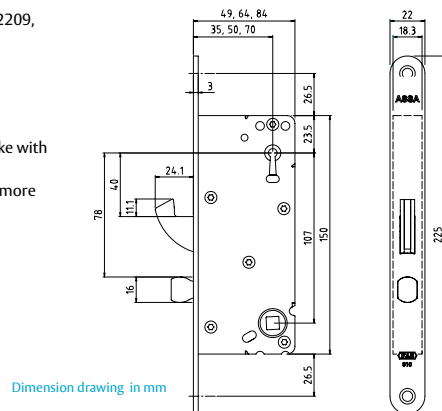

Door and window locks



ASSA 309 Connect

Application

The ASSA 309 Connect is an extra lock for doors in private houses, commercial buildings, and buildings with extra high demand for burglary resistance. The lock's self-blocking and patented hook bolt connect door and frame, making it extremely hard to force the door open.

The locking mechanism is well protected in the interior of the lock case, behind the door and escutcheon, which makes it difficult to manipulate or attack this vital part of the lock.

Features/function

The ASSA Connect can easily be assembled key alike with the traditional ASSA lever lock range. The size and shape of the lock case correspond to the most common extra locks on the market. This makes it easy to upgrade older products to higher security. The new smoother design of the key makes it more user friendly and ergonomic. The lock meets the requirements of EN 12209 grade 5.

Standard design

- Lock of galvanised steel
- Supplied with 3 brass keys, total length 80 mm
- Brass lever
- Hardened hook bolt that hampers attempts at sawing through the lock

Special design

- Key Alike can be ordered on demand
- Micro switch indication
- Hardened steel keys. Available in 68 mm, 80 mm, 90 mm and 125 mm lengths

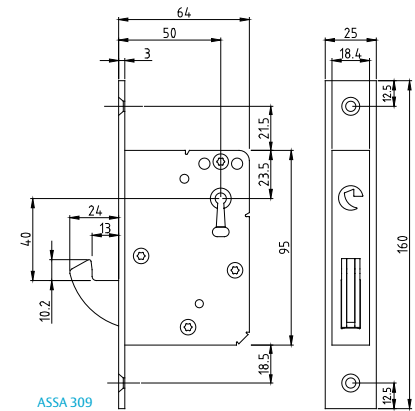



ASSA 1220

Reinforcement device

ASSA 1220

Application

The ASSA 1220 is a trailing edge device that protects the hinged side of the door. It consists of a strike plate fitted in the frame, and a plate with two hardened pins fitted in the door. The design hampers attempts at sawing or attacks using a beater.

The six screws provide a force resistance of over 700 kg. Can also be complemented with ASSA 5201 to enhance the strength of the door/frame. Incl. screw.

The device meets requirements of SS 3487 for protection of the hinged side of the door.

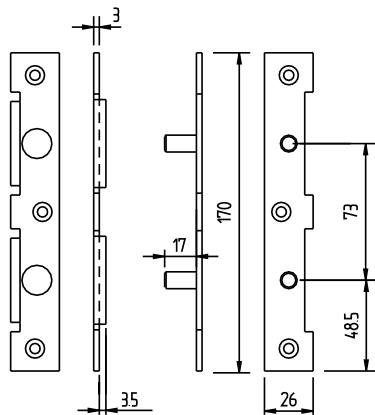

Dimension drawing in mm

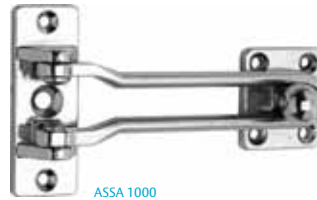

ASSA 1000

Reinforcement device

ASSA 1000 Door catch

Application

The ASSA 1000 is a door catch for outward opening doors. The door catch is designed with a knob mounted on the door frame connecting with a catch mounted on the door. When the catch is placed over the knob the door catch is in locked position, allowing the door to open maximum of 50 mm. The catch is designed to move with some friction and can only be released when the door is closed. Thanks to the strong steel screws through the door and the design of the catch, the door is substantially stronger than with a traditional door chain.

The door catch is manufactured in cast zinc with a chromium finish.

With the steel through screw and its design, this door catch is substantially stronger than a "door chain".

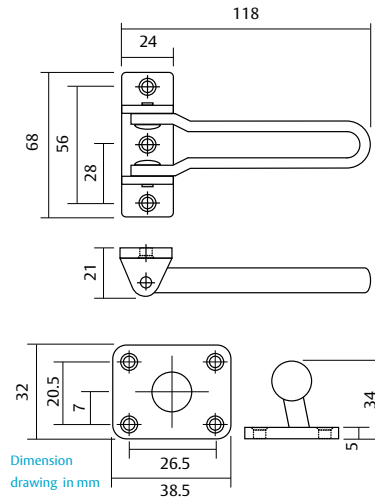

Dimension drawing in mm



ASSA 2020



ASSA 40C



ASSA 40T

For interior and bathroom/toilet doors

ASSA 2020 Latch lock

Application

The ASSA 2020 is a latch lock for internal doors, bathroom and toilet doors in the office/home sector, for new buildings and the replacement market.

Features/function

The ASSA 2020 can be operated with a key from both the inside and the outside, or with a thumbturn from the inside and a panic key or screwdriver from the outside.

The lock can easily be changed to a right or left-handed model by pulling and turning the latch bolt 180°.

The ASSA 2020 replaces the ASSA 404 and ASSA 404T.

Standard design

- Lock case and strike plate in yellow epoxy
- Delivered with one key
- Changeable to right or left-handed model pulling and turning the latch bolt 180°

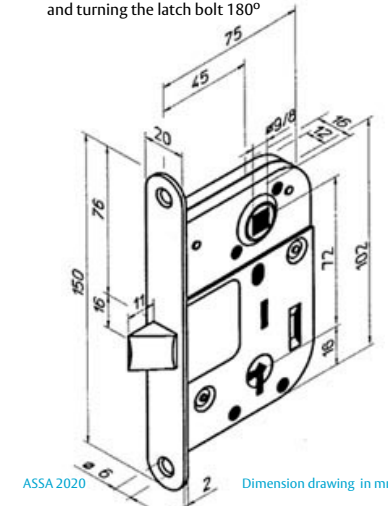

ASSA 2020

Dimension drawing in mm

For interior and bathroom/toilet doors

ASSA 40C and 40T Dead bolt locks

Application

The ASSA 40C and 40T are dead bolt locks for internal doors. They are intended for bathroom and toilet doors for the office/home sector, new buildings and the replacement market.

Features/function

The ASSA 40C is a 3-lever lock with 44 different key combinations, and is operated using a key from both the inside and outside.

The ASSA 40T, for toilet or bathroom doors, is operated using a thumbturn from the inside, and a panic key or screwdriver from the outside.

The lock is available in both right and left-handed, and has slot measurements that match older slot standards.

Standard design

- Lock case and strike plate of galvanised steel
- The 40C is supplied with 2 keys and strike plate
- The 40T is supplied with strike plate
- The dead bolt is reversible when dismantled

Special design

- Key Alike 40C
- According to key number 40C

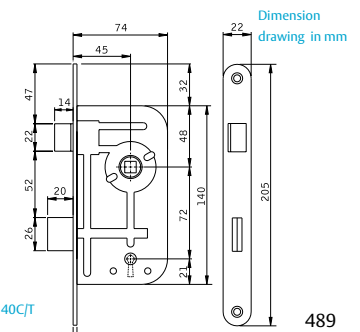

ASSA 40C/T

Dimension drawing in mm



INDUSTRIAL LOCKS

ASSA industrial locks include a wide range of products to meet every locking need. From the simplest cabinet to the most advanced solutions with high security. Our products are the results of many years of experience, and we can work with you to develop locks that meet your company's needs for design and security.

The concept of industrial locks holds many opportunities. To name a few examples, cabinets, safe-deposit boxes, vending machines, letterboxes and more.

ASSA OEM AB
Kungsgatan 71
SE-631 05 Eskilstuna
Sweden
Phone: +46 (0)16 17 70 00
e-mail: kundservice.etuna@assaoem.se
www.assaoem.se





Security levels

The security levels of our industrial locks are color coded.

Green level

Limited security, such as the ASSA 3-pin cylinder.

Yellow level

Normal security, such as the ASSA 5-pin cylinder.

Red level

High security with key control, such as the ASSA Desmo.



ASSA Unimille-Flexible coin lock for lockers

Application

ASSA's new coin lock series, Unimille, is the perfect solution for any location requiring temporary, safe storage of belongings.

Examples include storage of clothing and valuables at gyms and public pools, theaters, hospitals, libraries, stores or bus and train stations.

Properties

We developed the Unimille series with security, flexibility, design and performance in mind. The materials and design are specially intended to suit humid, corrosive environments. The locks are fitted with a sturdy hook bolt, which ensures extra strength in the connection between door and frame. The lock can be adapted for most coins used in the world.

The ASSA Unimille series comes in seven basic versions. You can also choose between two levels of security of the lock cylinder, resulting in a total of 14 different versions. Perfect for any situation. And of course the lock is available for right and left doors.

Variant A has a coin slot. When the correct coin is deposited, the lock becomes operational, allowing key removal. The coin is automatically returned when the lock is opened. Another option here is to fit the lock with a coin box that collects the coin on unlocking, meaning that the user pays a small fee for the use of the locker.

Variant B has two coin slots, but only one is needed for access to the locker. This way, the user can choose to deposit, say, £1 or 1 euro coin, making the lock more user friendly. Other coinages are of course available. Ideal in border areas between countries. A coin box is also an option for variant B.

Variant C has two coin slots and both coins are required for access to the locker. This larger deposit reduces the risk of keys "walking off." Like the A and B versions, you can choose to install a coin box.

Variant D is always fitted with a coin box. The user inserts two coins and can then open and close the locker an unlimited number of times without putting in additional coins. When the user leaves the locker for good, he or she presses the (R) return button and receives one coin in return, while the other drops into the coin box as payment.



Coin locks

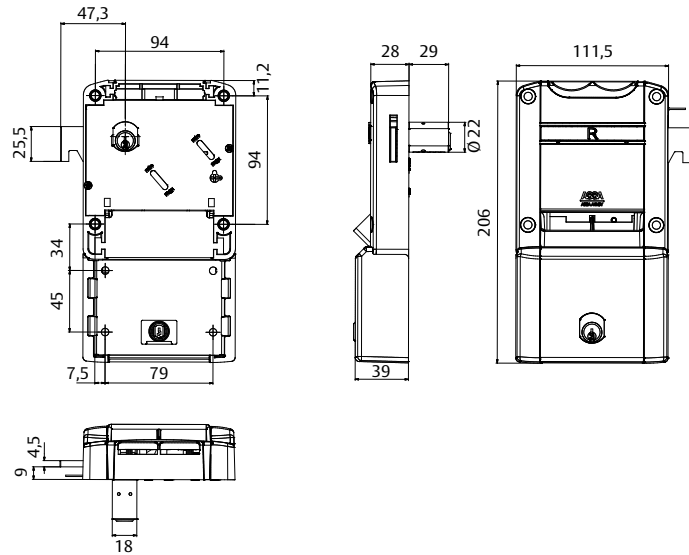

Security levels, cylinders

The ASSA Unimille is always delivered with interchangeable cylinders. This provides several advantages—for example, you can easily replace the cylinder of a coin lock if the key should disappear.

ASSA 6-pin cylinders offer a medium level of security with a large number of possible combinations. The high-quality cylinder is very reliable in all types of environments.

The ASSA Desmo is a top-security lock cylinder. It offers a large number of combinations, allowing you to build large lock systems with it. Keys can only be copied at the factory, minimizing the risk of illicit copying. There are currently no known methods of manipulating the ASSA Desmo cylinder. Its design ensures that the key is extremely strong.

The “penalty” function

The penalty function prevents users from “keeping” their locker by not returning the key after use. If you choose the Desmo cylinder for your Unimille lock, the penalty function is standard.

The lock owner has a special key that empties the deposit (the coin) from the lock, resetting locks in which the key was not returned. The person who kept the key must insert a new deposit when he/she returns to the locker in order to keep using it.

This function is standard on locks with the Desmo cylinder and is available as an option on the 6-pin cylinder.

Other properties

- Adjustable to different coinage
- Automatic coin reject
- All coin boxes in the same system have the same access lock



Cassette card locks



Application

The ASSA cassette card lock is a perfect solution for temporary storage of for example clothes and valuables at sports centers, public pools, theaters, hospitals, etc.

Features

The ASSA cassette card lock is a mechanical card lock for cupboards. Hole-punched cards or tickets will give access to the lock using keys. The lock is of universal type; both cards and tickets (one hole punched) can be used in same lock. On request, when assembling the locks, 10 different card codes are available.

The cassette lock can be ordered for right-or left-hung lockers. A range for cylinders covering different demands of material thickness and security levels can be used. The cylinder is master keyed.

The lock is made for use in wet areas: Lock case of polycarbonate, cylinder of chromed brass, keys and hook bolt of nickel-plated brass.

Function

When the card or the ticket is inserted in the cassette, the door can be locked and the key removed. In locked position the card or ticket remains captive in the lock cassette. The insertion of a card or a ticket becomes the deposit, which enables the key to be taken away by the customer. After use, when the door is unlocked, the key remains captive in the lock, available for the next customer.

Different card codes can be used in different areas of the facility.

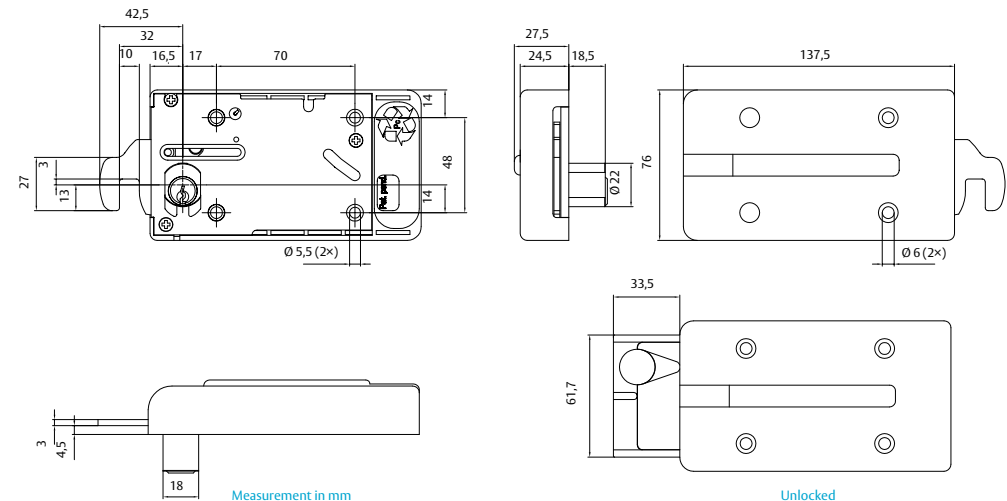



Locker hasps



4928 31

39 13 50

39 06 84

39 07 85

Application

ASSA locker hasps 39 13 50, 39 07 85 and 39 06 84 for material thickness up to 16 mm. Large selection of 3 mm thick catches.

Function

In locked position, the padlock stops the catch from turning. When the padlock is removed, the catch can be turned 90° and the locker can be opened. Right-hand turning is standard and left-hand is available on request. For the best function, ASSA recommends padlocks with a shackle thickness between 5 mm and 7 mm and a minimum shackle opening of 19 mm.

Accessories

The Turn 391 039 can be delivered together with a locker hasp with a pivoting arm (390 785). The composite turn protects the pivoting arm and creates a more user-friendly turn.

39 13 50

Chrome-plated zinc. Satin chrome-plated zinc on request.

39 06 84

Zinc-plated steel.

39 07 85

Zinc-plated steel. With pivoting arm.

Notes:

For catches, see the "Catches" data sheet.
For spare parts, see the "Spare parts" data sheet.

Ref. no.	Mtrl. thickness (up to):	Material
390 785	16 mm	Steel
390 684	16 mm	Steel
391 350	16 mm	Zinc
492 831	22 mm	Steel

Turn 39 10 39

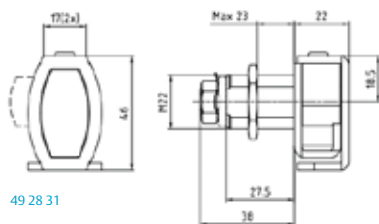

4928 31

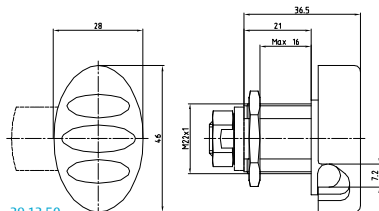

39 13 50

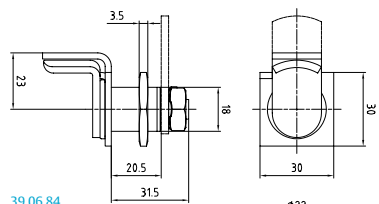

39 06 84

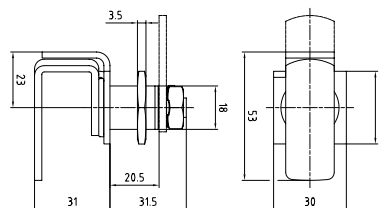

39 07 85

Measurement in mm



Coin locks



ASSA E-Lite

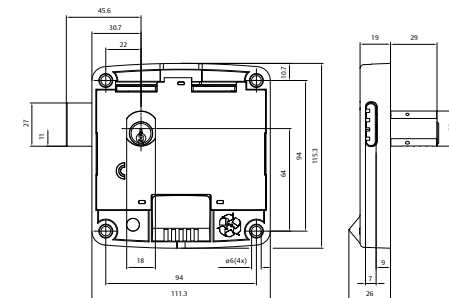

Measurement in mm



NORMAL SECURITY

ASSA E-Lite

Application

ASSA E-Lite Single Coin Coinlock is available for use with €1, 1€ and 2€. The lock is provided with an integrated coin return tray. The coinlock is to be equipped with a 5-pin changeable cylinder or a wafer changeable cylinder. For wet environments such as lockers in swimming areas and the like the E-lite Coinlock model should only be used with 5-pin cylinder. The lock is available in both right hand and left hand model. If a round hole has been made in the door ASSAs reinforcement plate, part number 492875, is recommended. The reinforcement plate is ordered separately.

Function

When the correct coin is inserted the door can be locked and the key removed. When the lock is opened with the key the coin falls into the return tray. When inserting a coin with too small diameter the coin will automatically fall into the return tray, causing no problems with jamming locks for the facility manager. ASSA E-Lite Single Coin Coinlock is designed to always keep the key captive in the lock after use, leaving it available for a new visitor.

Coinlocks

Part number does not include cylinder. The cylinders are ordered separately.

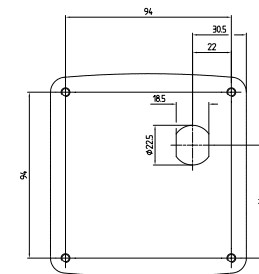

Hole preparation in mm

Part number	Version	RH/LH
290511 111 087	1€	RH
290511 125 087	€1	RH
290511 129 087	2€	RH
290512 111 087	1€	LH
290512 125 087	€1	LH
290512 129 087	2€	LH

Part number	Type of Cylinder		Type of Key				RH/LH	Cylinder-length
	Wafer	5-Pin	Wafer	Maxi	Mini	Wrist-band		
363407	X		X				RH/LH	26 mm
391513		X		X			RH	29 mm
391550		X			X		RH	29 mm
391646		X				X	RH	29 mm
391514		X		X			LH	29 mm
391551		X			X		LH	29 mm
391647		X				X	LH	29 mm



Cam lock cylinders



Casino lock ASSA Desmo RCX

Application

The removable cylinder, RCX, is based on 8-pin Desmo technology, which enables master keying and a very high number of differs. Cylinders are made of chrome-plated brass and keys of nickel silver.

Function

The removable core makes it possible to change the core with the ease of a key operation. In literally seconds the core can be removed or installed in the housing using the management key. This makes pre-installations of the locks simple and safe, and in the case of a lost user key, changing the key code of the lock is fast and easy.

The removable cylinder is available in three different

cam lock housings and one microswitch lock housing: a 1 1/8" cam lock with 90° or 180° rotation and a key that can only be removed in locked position (part no. 395164); a 1 1/8" cam lock with 90° rotation and a key that can be removed in both locked and unlocked position (part no. 395168); a 5/8" cam lock with 90° or 180° rotation and a key that can only be removed in locked position (part no. 361530); and the ASSA Desmo 8925 micro-switchlock (part no. 395171).

The cam locks all have right-hand turning as standard and left-hand available on request. The cam locks can easily be changed from left-handed to right-handed or vice versa on site.

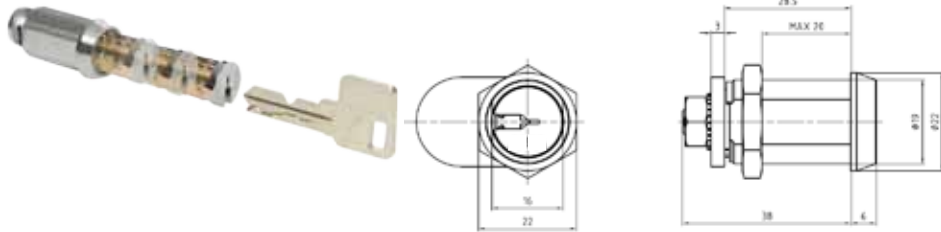

Measurement in mm



Cam lock 8920 Desmo

Application

Lock for cabinets, drawers, vending machines, etc.

Features

The ASSA Desmo is 8-pin cylinder lock for material thickness up to 16 mm. The construction is based on direct driven pins without springs. Master keying and very high number of differs. Cylinders of nickel-plated

brass and keys of nickel silver. Drill protection is available on request. Large selection of 3 mm catches.

Function

The key turns 90° and can only be removed when the catch is in the locked position. Right-hand turning is standard and left-hand is available on request.

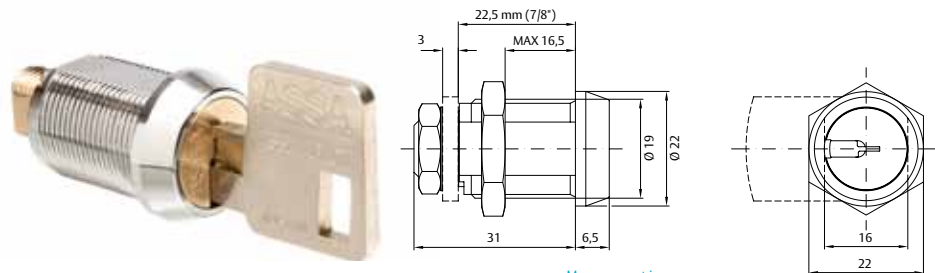

Measurement in mm



Cam lock cylinders



Cam lock 8460

Application

Lock for cabinets, drawers, vending machines, etc.

Features

6-pin cam lock for material thickness up to 20 mm. Cylinders and keys of nickel-plated brass. Large selection of 3 mm thick catches. Can be master keyed.

Function

The key turns 90° and can only be removed in locked position. Right-hand turning is standard and left-hand is available on request.

CODED 1.0

Application

ASSA CODED 1.0 is a standalone battery operated combination lock. The lock is designed as a key free alternative to traditional cabinet locks. The lock is intended for dry indoor spaces, but can be supplemented with a sealing accessory for use in damp indoor environments. The lock can be easily installed on new cabinets and even retrofitted to most cabinet where there is a need to replace an existing cabinet locks.

Properties

- 10 button keypad
- User Codes are 4 digits long
- Master and Sub-Master Codes are 8 digits long
- Multiple User Code mode
- One Time User Code mode (locker mode).
- **NOTE!** For this feature we recommend ASSA CODED 1.2
- 15,000 openings with 2 x AAA cells (supplied)
- Battery failure override using 9V battery across LED's (+/-) and Master Code
- All parts / fixings / template included
- Available in two lengths for mounting in doors up to 16 mm or 22 mm thickness
- Utilizes the ASSA standard catch assortment
- Available as vertical model (standard) / horizontal Right Hand (RH) / horizontal Left Hand (LH)
- IP54 rated when used with the door gasket available as a separate part
- Reinforcement plate for stronger attachment available as separate part
- Zinc cast housing

Function

CODED1.0 works as a traditional camlock, but instead of using a key to access the lock a code is entered on the keypad. The lock uses the same catches as ASSA camlocks, see data sheet for catches. Catches are ordered separately. The catch is possible to rotate +/- 90°.



Cam lock 8460

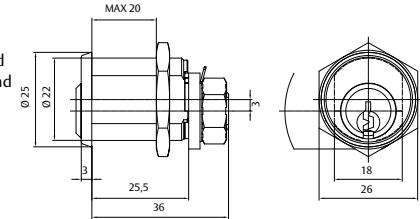

Measurement in mm



CODED 1.0

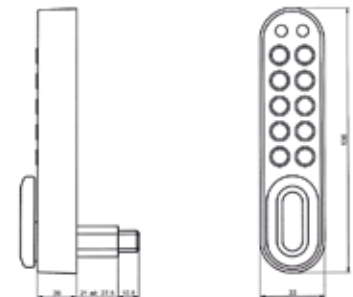

Measurement in mm



Special locks



ASSA 2970

ASSA 3970

ASSA 5970

ASSA 2970/3970/5970

Application

For doors requiring high security. ASSA lever tumbler locks 2970, 3970 and 5970 are suitable for cell doors in prisons, etc.

Features/function

ASSA locks 2970 and 3970 have an exchangeable lock cassette of the type ASSA 704 with 7 brass tumblers. The lock is equipped with two cylindrical rotating bolts that open with a quarter turn of the handle and have a throw of 20.5 mm. The lock cassette prevents the handle from being turned. The ASSA 2970 also has an espagnolette fastening for vertical locking.

The hole for the handle is 9 mm. There is a keyhole on one side only and the key can be removed in both the locked and unlocked positions.

The lock is available in both a left and a right-hand design but only with asymmetrical locking.

ASSA lock 5970 has the same design and function as above, apart from the lock cassette, which has been adapted for cylinder assembly.

Standard design

- Lock of powerful sheet steel
- 5970 adapted for single cylinder
- Keys/cylinder not included: order separately
- Brass lever
- Category B

Special design

- Keyed alike with category B locks, not 5970
- 5970 adapted for double cylinder
- Extra keys will only be produced if we receive the original key (2970, 3970)

Options

- Micro indicating locked/unlocked blocking device
- Micro indicating bolt position
- Solenoid for remote-controlled access = dual command
- Independent interlocking
- Not lockable when door is open

Special locks

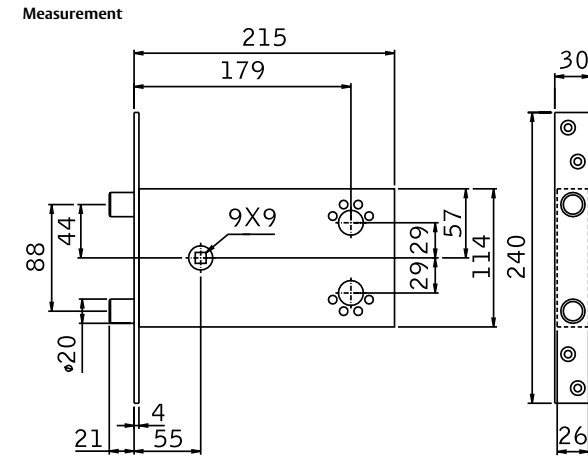

ASSA 2970 and ASSA 3970
Measurement in mm

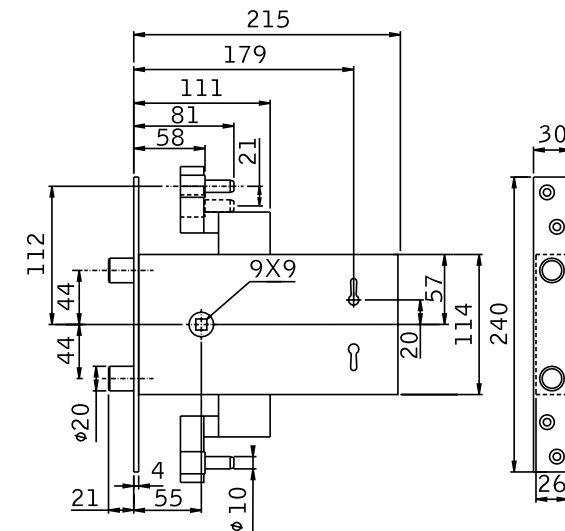

ASSA 5970
Measurement in mm



RUKO LINE



Designer lever handles from Ruko help create a coherent expression that combines high security with aesthetic quality.

We have gathered our three exclusive series together

- :DO:RE:MI:
- Holgaard
- Ruko-Line

Each series has its own strong expression, but all can be combined with each other. And with the broad range of Ruko Line accessories as the basis, it is possible to meet any need for door fittings.





3 exclusive designs on the same basis

Designer lever handles from Ruko help create a coherent expression that combines high security with aesthetic quality.

We have gathered our three exclusive series together

- :DO:RE:MI:
- Holgaard
- Ruko-Line

Each series has its own strong expression, but all can be combined with each other. And with the broad range of Ruko-Line accessories as the basis, it is possible to meet any need for door fittings.

:DO:RE:MI:

- by Arkitema

The :DO:RE:MI: range was developed in close co-operation with one of Scandinavia's leading architectural companies, Arkitema, in order to create a hardware series that is smart, durable and functional. It is the product of the architect's visual expression and Ruko's high standard for quality.

The Holgaard handle

The Holgaard handle was designed the young design office of Holgaard Arkitekt, to create a solution that combines the simple and ergonomic in a lever handle that supports the collective architecture.

Ruko-Line

- the basis of it all

Beautiful, timeless and solid solution of superior high quality, for furnishing first class projects and exciting environments throughout the entire world, either as independent solutions or as a basic assortment for Ruko's other designer handle solutions.





:DO: Lever handle without roses 0719

Lever handle without roses. Supplied with 8 x 8 mm spindle in stainless steel.

:DO:RE:MI: lever handles are fitted with needle bearings.

:DO: RE:MI: is manufactured in satin stainless steel grade AISI 316L.

For other products like cylinder rings, back plates etc., please see the Ruko-Line section.



Article No.	Ref. No.	Description
951103	0719-0332	:DO: Lever handle without roses Door thickness 32 - 60 mm
951107	0719-0360	:DO: Lever handle without roses Door thickness 60 - 85 mm
951108	0719-0385	:DO: Lever handle without roses Door thickness 85 - 110 mm

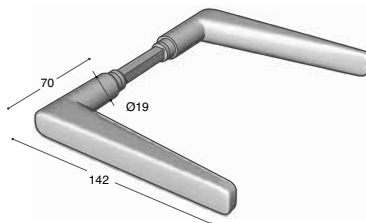

:DO: Lever handle with roses 0719

Lever handle with roses. Supplied with 8 x 8 mm spindle in stainless steel.

Lever handles with roses are supplied with 2 pcs. M4 x 75 mm through going screws.

Centre distance 30 or 38 mm.

:DO:RE:MI: lever handles with 30 mm centre roses are supplied with Ruko lever handle plug.

:DO:RE:MI: lever handles are fitted with needle bearings.

:DO: RE:MI: is manufactured in satin stainless steel grade AISI 316L.

For other products like cylinder rings, back plates etc., please see the Ruko-Line section.



Article No.	Ref. No.	Description
951102	0719-0432	:DO: Lever handle with roses 30 mm centre. Door thickness 32 - 60 mm
951105	0719-0460	:DO: Lever handle with roses 30 mm centre. Door thickness 60 - 85 mm
951106	0719-0485	:DO: Lever handle with roses 30 mm centre. Door thickness 85 - 110 mm
951104	0719-0632	:DO: Lever handle with roses 38 mm centre. Door thickness 32 - 60 mm
951109	0719-0660	:DO: Lever handle with roses 38 mm centre. Door thickness 60 - 85 mm
951110	0719-0685	:DO: Lever handle with rose 38 mm centre. Door thickness 85 - 110 mm

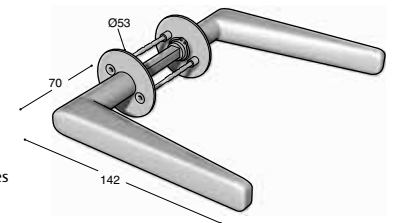



:DO: Pull handle 7514

Straight pull handle for door thickness 10 - 70 mm.

Size: 14 mm diameter x 125 mm centre distance.

Pull handles are supplied with screws and glass door accessories.

:DO:RE:MI: is manufactured in satin stainless steel grade AISI 316L.

For other products like cylinder rings, back plates etc, please see the Ruko-Line section.

Article No.	Ref. No.	Description
951141	7514-01125	:DO: Single pull handle 14 x 125 mm
951142	7514-02125	:DO: Pair of pull handles 14 x 125 mm

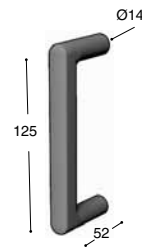

:DO: Pull handle 7519

Straight pull handle for door thickness 10 - 70 mm.

Size: 19 mm diameter x 200 mm centre distance.

Pull handles are supplied with screws and glass door accessories.

:DO:RE:MI: is manufactured in satin stainless steel grade AISI 316L.

For other products like cylinder rings, back plates etc, please see the Ruko-Line section.

Article No.	Ref. No.	Description
951143	7519-01200	:DO: Single pull handle 19 x 200 mm
951144	7519-02200	:DO: Pair of pull handles 19 x 200 mm

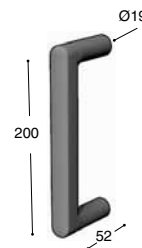

:DO: Pull handle 7524

Straight pull handle for door thickness 10 - 70 mm.

Size: 24 mm diameter x 300 mm centre distance.

Pull handles are supplied with screws and glass door accessories.

:DO:RE:MI: is manufactured in satin stainless steel grade AISI 316L.

For other products like cylinder rings, back plates etc, please see the Ruko-Line section.

Article No.	Ref. No.	Description
951145	7524-01300	:DO: Single pull handle 24 x 300 mm
951146	7524-02300	:DO: Pair of pull handles 24 x 300 mm

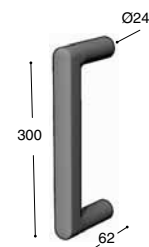



:RE: Lever handle without roses 0625

Lever handle without roses. Supplied with 8 x 8 mm spindle in stainless steel.

:DO:RE:MI: lever handles are fitted with needle bearings.

:DO:RE:MI: is manufactured in satin stainless steel grade AISI 316L.

For other products like cylinder rings, back plates etc., please see the Ruko-Line section.



Article No.	Ref. No.	Description
951003	0625-0332	:RE: Lever handle without roses Door thickness 32 - 60 mm
951008	0625-0360	:RE: Lever handle without roses Door thickness 60 - 85 mm
951009	0625-0385	:RE: Lever handle without roses Door thickness 85 - 110 mm

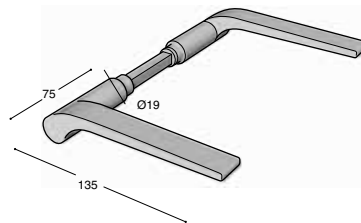

:RE: Lever handle with roses 0625

Lever handle with roses. Supplied with 8 x 8 mm spindle in stainless steel.

Lever handles with roses are supplied with 2 pcs. M4 x 75 mm through going screws.

Centre distance 30 or 38 mm.

:DO:RE:MI: lever handles with 30 mm centre roses are supplied with Ruko lever handle plug.

:DO:RE:MI: lever handles are fitted with needle bearings.

:DO:RE:MI: is manufactured in satin stainless steel grade AISI 316L.

For other products like cylinder rings, back plates etc., please see the Ruko-Line section.



Article No.	Ref. No.	Description
951005	0625-0432	:RE: Lever handle with roses 30 mm centre. Door thickness 32 - 60 mm
951006	0625-0460	:RE: Lever handle with roses 30 mm centre. Door thickness 60 - 85 mm
951007	0625-0485	:RE: Lever handle with roses 30 mm centre. Door thickness 85 - 110 mm
951004	0625-0632	:RE: Lever handle with roses 38 mm centre. Door thickness 32 - 60 mm
951010	0625-0660	:RE: Lever handle with roses 38 mm centre. Door thickness 60 - 85 mm
951011	0625-0685	:RE: Lever handle with roses 38 mm centre. Door thickness 85 - 110 mm

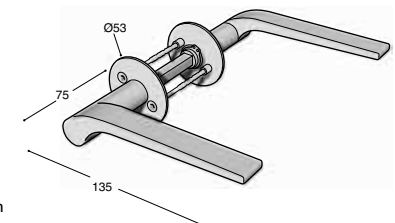



:RE: Pull handle 7414

Straight pull handle for door thickness 10 - 70 mm.

Size: 14 mm diameter x 125 mm centre distance.

Pull handles are supplied with screws and glass door accessories.

:DO:RE:MI: is manufactured in satin stainless steel grade AISI 316L.

For other products like cylinder rings, back plates etc., please see the Ruko-Line section.

Article No.	Ref. No.	Description
951041	7414-01125	:RE: Single pull handle 14 x 125 mm
951042	7414-02125	:RE: Pair of pull handles 14 x 125 mm

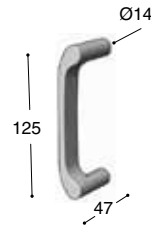

:RE: Pull handle 7419

Straight pull handle for door thickness 10 - 70 mm.

Size: 19 mm diameter x 200 mm centre distance.

Pull handles are supplied with screws and glass door accessories.

:DO:RE:MI: is manufactured in satin stainless steel grade AISI 316L.

For other products like cylinder rings, back plates etc., please see the Ruko-Line section.

Article No.	Ref. No.	Description
951043	7419-01200	:RE: Single pull handle 19 x 200 mm
951044	7419-02200	:RE: Pair of pull handles 19 x 200 mm

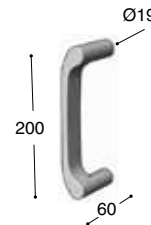

:RE: Pull handle 7424

Straight pull handle for door thickness 10 - 70 mm.

Size: 24 mm diameter x 300 mm centre distance.

Pull handles are supplied with screws and glass door accessories.

:DO:RE:MI: is manufactured in satin stainless steel grade AISI 316L.

For other products like cylinder rings, back plates etc., please see the Ruko-Line section.

Article No.	Ref. No.	Description
951045	7424-01300	:RE: Single pull handle 24 x 300 mm
951046	7424-02300	:RE: Pair of pull handles s24 x 300 mm

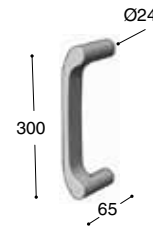



:MI: Lever handle without roses 0519

Lever handle without roses. Supplied with 8 x 8 mm spindle in stainless steel.

:DO:RE:MI: lever handles are fitted with needle bearings.

:DO:RE:MI: is manufactured in satin stainless steel grade AISI 316L.

For other products like cylinder rings, back plates etc., please see the Ruko-Line section.

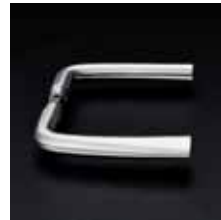

Article No.	Ref. No.	Description
951203	0519-0332	:MI: Lever handle without roses Door thickness 32 - 60 mm
951209	0519-0360	:MI: Lever handle without roses Door thickness 60 - 85 mm
951210	0519-0385	:MI: Lever handle without roses Door thickness 85 - 110 mm

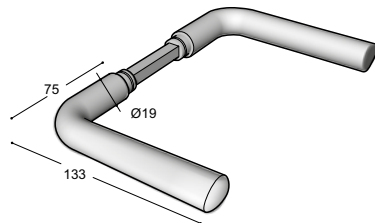

:MI: Lever handle with roses 0519

Lever handle with roses. Supplied with 8 x 8 mm spindle in stainless steel.

Lever handles with roses are supplied with 2 pcs. M4 x 75 mm through going screws.

Centre distance 30 or 38 mm.

:DO:RE:MI: lever handles with 30 mm centre roses are supplied with Ruko lever handle plug.

:DO:RE:MI: lever handles are fitted with needle bearings.

:DO:RE:MI: is manufactured in satin stainless steel grade AISI 316L.

For other products like cylinder rings, back plates etc., please see the Ruko-Line section.



Article No.	Ref. No.	Description
951202	0519-0432	:MI: Lever handle with roses 30 mm centre. Door thickness 32 - 60 mm
951207	0519-0460	:MI: Lever handle with roses 30 mm centre. Door thickness 60 - 85 mm
951208	0519-0485	:MI: Lever handle with roses 30 mm centre. Door thickness 85 - 110 mm
951204	0519-0632	:MI: Lever handle with roses 38 mm centre. Door thickness 32 - 60 mm
951211	0519-0660	:MI: Lever handle with roses 38 mm centre. Door thickness 60 - 85 mm
951212	0519-0685	:MI: Lever handle with roses 38 mm centre. Door thickness 85 - 110 mm

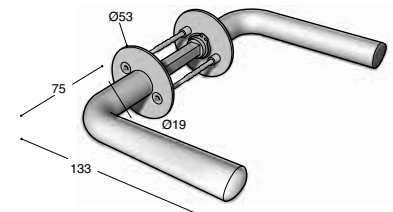



:MI: Pull handle 7314

Straight pull handle for door thickness 10 - 70 mm.

Size: 14 mm diameter x 125 mm centre distance.

Pull handles are supplied with screws and glass door accessories.

:DO:RE:MI: is manufactured in satin stainless steel grade AISI 316L.

For other products like cylinder rings, back plates etc., please see the Ruko-Line section.

Article No.	Ref. No.	Description
951241	7314-01125	:MI: Single pull handle 14 x 125 mm
951242	7314-02125	:MI: Pair of pull handles 14 x 125 mm

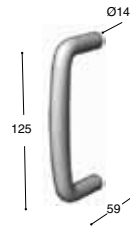

:MI: Pull handle 7319

Straight pull handle for door thickness 10 - 70 mm.

Size: 19 mm diameter x 200 mm centre distance.

Pull handles are supplied with screws and glass door accessories.

:DO:RE:MI: is manufactured in satin stainless steel grade AISI 316L.

For other products like cylinder rings, back plates etc., please see the Ruko-Line section.

Article No.	Ref. No.	Description
951243	7319-01200	:MI: Single pull handle 19 x 200 mm
951244	7319-02200	:MI: Pair of pull handles 19 x 200 mm

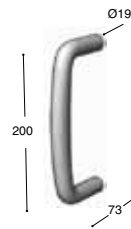

:MI: Pull handle 7324

Straight pull handle for door thickness 10 - 70 mm.

Size: 24 mm diameter x 300 mm centre distance.

Pull handles are supplied with screws and glass door accessories.

:DO:RE:MI: is manufactured in satin stainless steel grade AISI 316L.

For other products like cylinder rings, back plates etc., please see the Ruko-Line section.

Article No.	Ref. No.	Description
951245	7324-01300	:MI: Single pull handle 24 x 300 mm
951246	7324-02300	:MI: Pair of pull handles 24 x 300 mm

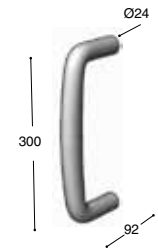



Holgaard lever handle without roses 1022

Lever handle without roses. Supplied with 8 x 8 mm spindle in stainless steel.

Holgaard lever handles are fitted with needle bearings.

Holgaard is manufactured in satin stainless steel grade AISI 316L

For other products like cylinder rings, back plates etc., please see the Ruko-Line section.

Article No.	Ref. No.	Description
951303	1022-0332	Lever handle without roses Door thickness 32-60 mm
951304	1022-0360	Lever handle without roses Door thickness 60-85 mm
951305	1022-0385	Lever handle without roses Door thickness 85-110 mm

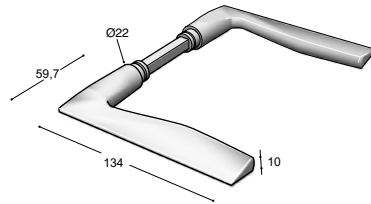

Holgaard lever handle with roses 1022

Lever handle with roses. Supplied with 8 x 8 mm spindle in stainless steel.

Lever handles with roses are supplied with 2 pcs. M4x75 mm through going screws.

Centre distance 30 mm or 38 mm.

Holgaard lever handles with 30 mm centre are supplied with Ruko lever handle plug.

Holgaard lever handles are fitted with needle bearings.

Holgaard is manufactured in satin stainless steel grade AISI 316L

For other products like cylinder rings, back plates etc., please see the Ruko-Line section.

Article No.	Ref. No.	Description
951300	1022-0432	Lever handle with roses 30 mm centre Door thickness 32-60 mm
951301	1022-0460	Lever handle with roses 30 mm centre Door thickness 60-85 mm
951302	1022-0485	Lever handle with roses 30 mm centre Door thickness 85-110 mm
951306	1022-0632	Lever handle with roses 38 mm centre Door thickness 32-60 mm
951307	1022-0660	Lever handle with roses 38 mm centre Door thickness 60-85 mm
951308	1022-0685	Lever handle with roses 38 mm centre Door thickness 85-110 mm

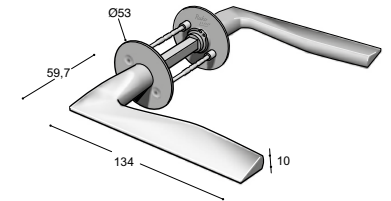



16 mm L-shape lever handle without roses 0116

Lever handle without roses. Supplied with 8 x 8 mm spindle in stainless steel.

Ruko-Line lever handles are fitted with needle bearings.

Ruko-Line is manufactured in satin stainless steel grade AISI 316L.

Article No.	Ref. No.	Description
951502	0116-0332	16 mm L-shape lever handle without roses Door thickness 32 - 85 mm

951910	9998-1885	Spindle for lever handle Door thickness 85 - 110 mm
--------	-----------	--

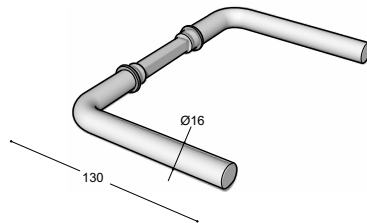

16 mm L-shape lever handle with roses 0116

Lever handle with roses. Supplied with 8 x 8 mm spindle in stainless steel.

Lever handles with roses are supplied with 2 pcs. M4 x 75 mm through going screws.

Centre distance 30 mm or 38 mm.

Ruko-Line lever handles with 30 mm centre roses are supplied with Ruko lever handle plug.

Ruko-Line lever handles are fitted with needle bearings.

Ruko-Line is manufactured in satin stainless steel grade AISI 316L.

Article No.	Ref. No.	Description
951501	0116-0432	16 mm L-shape lever handle with roses 30 mm centre. Door thickness 32 - 85 mm

951503	0116-0632	16 mm L-shape lever handle with roses 38 mm centre. Door thickness 32 - 85 mm
--------	-----------	--

951910	9998-1885	Spindle for lever handle Door thickness 85 - 110 mm
--------	-----------	--

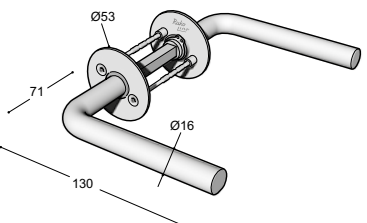

16 mm U-shape lever handle without roses 0216

Lever handle without roses. Supplied with 8 x 8 mm spindle in stainless steel.

Ruko-Line lever handles are fitted with needle bearings.

Ruko-Line is manufactured in satin stainless steel grade AISI 316L.

Article No.	Ref. No.	Description
951505	0216-0332	16 mm U-shape lever handle without roses Door thickness 32 - 85 mm

951910	9998-1885	Spindle for lever handle Door thickness 85 - 110 mm
--------	-----------	--

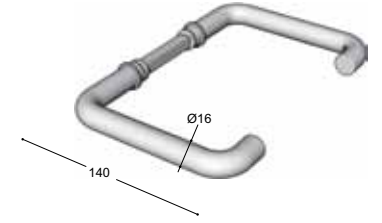

16 mm U-shape lever handle with roses 0216

Lever handle with roses. Supplied with 8 x 8 mm spindle in stainless steel.

Lever handles with roses are supplied with 2 pcs. M4 x 75 mm through going screws.

Centre distance 30 mm or 38 mm.

Ruko-Line lever handles with 30 mm centre roses are supplied with Ruko lever handle plug.

Ruko-Line lever handles are fitted with needle bearings.

Ruko-Line is manufactured in satin stainless steel grade AISI 316L.

Article No.	Ref. No.	Description
951504	0216-0432	16 mm U-shape lever handle with roses 30 mm centre. Door thickness 32 - 85 mm

951506	0216-0632	16 mm U-shape lever handle with roses 38 mm centre. Door thickness 32 - 85 mm
--------	-----------	--

951910	9998-1885	Spindle for lever handle Door thickness 85 - 110 mm
--------	-----------	--

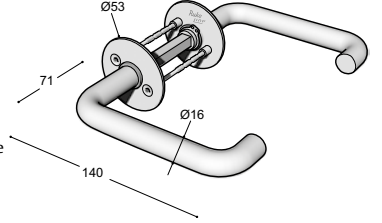



19 mm L-shape lever handle without roses 0119

Lever handle without roses. Supplied with 8 x 8 mm spindle in stainless steel.

Ruko-Line lever handles are fitted with needle bearings.

Ruko-Line is manufactured in satin stainless steel grade AISI 316L.

Article No.	Ref. No.	Description
951508	0119-0332	19 mm L-shape lever handle without roses Door thickness 32 - 85 mm
951910	9998-1885	Spindle for lever handle Door thickness 85 - 110 mm

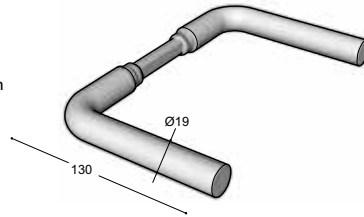

19 mm L-shape lever handle with roses 0119

Lever handle with roses. Supplied with 8 x 8 mm spindle in stainless steel.

Lever handles with roses are supplied with 2 pcs. M4 x 75 mm through going screws.

Centre distance 30 mm or 38 mm.

Ruko-Line lever handles with 30 mm centre roses are supplied with Ruko lever handle plug.

Ruko-Line lever handles are fitted with needle bearings.

Ruko-Line is manufactured in satin stainless steel grade AISI 316L.

Article No.	Ref. No.	Description
951507	0119-0432	19 mm U-shape lever handle with roses 30 mm centre. Door thickness 32 - 85 mm
951509	0119-0632	19 mm L-shape lever handle with roses 38 mm centre. Door thickness 32 - 85 mm
951910	9998-1885	Spindle for lever handle Door thickness 85 - 110 mm

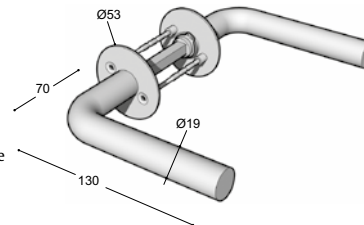

19 mm U-shape lever handle without roses 0219

Lever handle without roses. Supplied with 8 x 8 mm spindle in stainless steel.

Ruko-Line lever handles are fitted with needle bearings.

Ruko-Line is manufactured in satin stainless steel grade AISI 316L.

Article No.	Ref. No.	Description
951511	0219-0332	19 mm U-shape lever handle without roses Door thickness 32 - 85 mm
951910	9998-1885	Spindle for lever handle Door thickness 85 - 110 mm

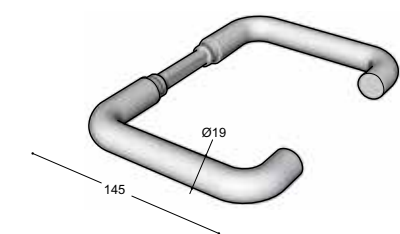

19 mm U-shape lever handle with roses 0219

Lever handle with roses. Supplied with 8 x 8 mm spindle in stainless steel.

Lever handles with roses are supplied with 2 pcs. M4 x 75 mm through going screws.

Centre distance 30 mm or 38 mm.

Ruko-Line lever handles with 30 mm centre roses are supplied with Ruko lever handle plug.

Ruko-Line lever handles are fitted with needle bearings.

Ruko-Line is manufactured in satin stainless steel grade AISI 316L.

Article No.	Ref. No.	Description
951510	0219-0432	19 mm U-shape lever handle with roses 30 mm centre. Door thickness 32 - 85 mm
951512	0219-0632	19 mm U-shape lever handle with roses 38 mm centre. Door thickness 32 - 85 mm
951910	9998-1885	Spindle for lever handle Door thickness 85 - 110 mm

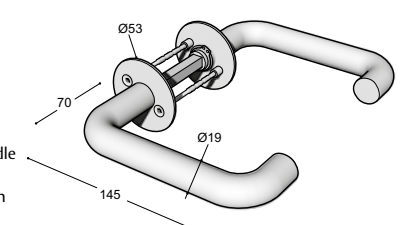



Cranked lever handle without roses 0419

Lever handle without roses. Supplied with 8 x 8 mm spindle in stainless steel.

Ruko-Line lever handles are fitted with needle bearings.

Ruko-Line is manufactured in satin stainless steel grade AISI 316L

Article No.	Ref. No.	Description
951516	0419-0332	Lever handle without roses Door thickness 32 - 85 mm

951910	9998-1885	Spindle for lever handle Door thickness 85 - 110 mm
--------	-----------	--

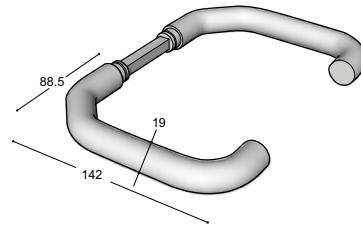

Cranked lever handle with narrow style roses 0419

Lever handle with roses. Supplied with 8 x 8 mm spindle in stainless steel.

Lever handles with roses are supplied with 2 pcs. M4 x 75 mm through going screws.

Centre distance 43 mm or 50 mm.

Ruko-Line lever handles are fitted with needle bearings.

Ruko-Line is manufactured in satin stainless steel grade AISI 316L

Article No.	Ref. No.	Description
951517	0419-0832	Lever handle with roses. 43 mm centre Door thickness 32 - 85 mm

951518	0419-1032	Lever handle with roses. 50 mm centre Door thickness 32 - 85 mm
--------	-----------	---

951910	9998-1885	Spindle for lever handle Door thickness 85 - 110 mm
--------	-----------	--

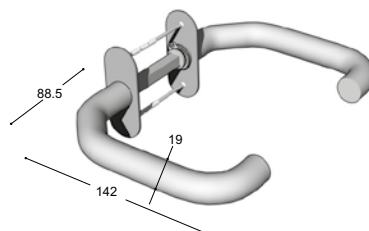

Cranked lever handle with roses 0419

Lever handle with roses. Supplied with 8 x 8 mm spindle in stainless steel.

Lever handles with roses are supplied with 2 pcs. M4 x 75 mm through going screws.

Centre distance 30 mm or 38 mm.

Ruko-Line lever handles with 30 mm centre are supplied with Ruko lever handle plug.

Ruko-Line lever handles are fitted with needle bearings.

Ruko-Line is manufactured in satin stainless steel grade AISI 316L

Article No.	Ref. No.	Description
951473	0419-0432	Lever handle with roses. 30 mm centre Door thickness 32 - 85 mm

951476	0419-0632	Lever handle with roses. 38 mm centre Door thickness 32 - 85 mm
--------	-----------	---

951910	9998-1885	Spindle for lever handle Door thickness 85 - 110 mm
--------	-----------	--

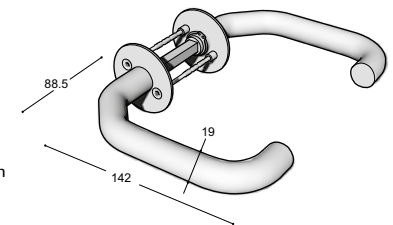



Coupé lever handle without roses 0319

Lever handle without roses. Supplied with 8 x 8 mm spindle in stainless steel.

Ruko-Line lever handles are fitted with needle bearings.

Ruko-Line is manufactured in satin stainless steel grade AISI 316L.

Article No.	Ref. No.	Description
951513	0319-0332	Lever handle without roses Door thickness 32 - 85 mm

951910	9998-1885	Spindle for lever handle Door thickness 85 - 110 mm
--------	-----------	--

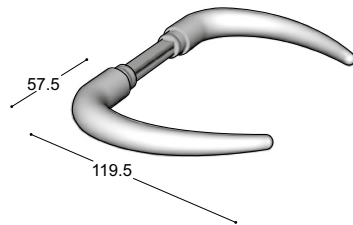

Coupé lever handle with roses 0319

Lever handle with roses. Supplied with 8 x 8 mm spindle in stainless steel.

Lever handles with roses are supplied with 2 pcs. M4 x 75 mm through going screws.

Centre distance 30 mm or 38 mm.

Ruko-Line lever handles with 30 mm centre are supplied with Ruko lever handle plug.

Ruko-Line lever handles are fitted with needle bearings.

Ruko-Line is manufactured in satin stainless steel grade AISI 316L.

Article No.	Ref. No.	Description
951514	0319-0432	Lever handle with roses. 30 mm centre Door thickness 32 - 85 mm

951515	0319-0632	Lever handle with roses. 38 mm centre Door thickness 32 - 85 mm
--------	-----------	---

951910	9998-1885	Spindle for lever handle Door thickness 85 - 110 mm
--------	-----------	--

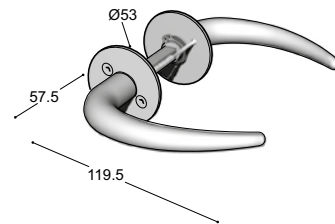

Hospital 19 x 135 mm lever handle without roses 0819

Lever handle without roses. Supplied with 8 x 8 mm spindle in stainless steel.

Ruko-Line lever handles are fitted with needle bearings.

Ruko-Line is manufactured in satin stainless steel grade AISI 316L.

Article No.	Ref. No.	Description
951851	0819-0332	Lever handle without roses Door thickness 32 - 85 mm

951910	9998-1885	Spindle for lever handle Door thickness 85 - 110 mm
--------	-----------	--

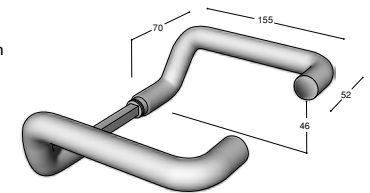

Hospital 19 x 135 mm lever handle with roses 0819

Lever handle with roses. Supplied with 8 x 8 mm spindle in stainless steel.

Lever handles with roses are supplied with 2 pcs. M4 x 75 mm through going screws.

Centre distance 30 mm or 38 mm.

Ruko-Line lever handles with 30 mm centre are supplied with Ruko lever handle plug.

Ruko-Line lever handles are fitted with needle bearings.

Ruko-Line is manufactured in satin stainless steel grade AISI 316L.

Article No.	Ref. No.	Description
951852	0819-0432	Lever handle with roses. 30 mm centre Door thickness 32 - 85 mm

951853	0819-0632	Lever handle with roses. 38 mm centre Door thickness 32 - 85 mm
--------	-----------	---

951910	9998-1885	Spindle for lever handle
--------	-----------	--------------------------

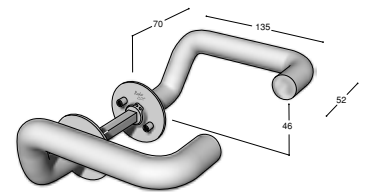



Hospital 19 x 155 mm lever handle without roses 0919

Lever handle without roses. Supplied with 8 x 8 mm spindle in stainless steel.

Ruko-Line lever handles are fitted with needle bearings.

Ruko-Line is manufactured in satin stainless steel grade AISI 316L.

Article No.	Ref. No.	Description
951863	0919-0332	Lever handle without roses Door thickness 32 - 85 mm
951910	9998-1885	Spindle for lever handle Door thickness 85 - 110 mm

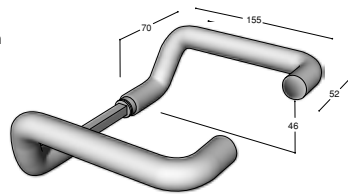

Hospital 19 x 155 mm lever handle with roses 0919

Lever handle with roses. Supplied with 8 x 8 mm spindle in stainless steel.

Lever handles with roses are supplied with 2 pcs. M4 x 75 mm through going screws.

Centre distance 30 mm or 38 mm.

Ruko-Line lever handles with 30 mm centre are supplied with Ruko lever handle plug.

Ruko-Line lever handles are fitted with needle bearings.

Ruko-Line is manufactured in satin stainless steel grade AISI 316L.

Article No.	Ref. No.	Description
951884	0919-0432	Lever handle with roses. 30 mm centre Door thickness 32 - 85 mm
951887	0919-0632	Lever handle with roses. 38 mm centre Door thickness 32 - 85 mm
951910	9998-1885	Spindle for lever handle

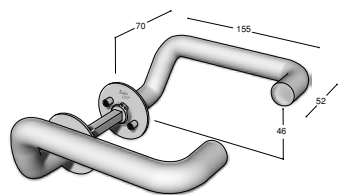

Cylinder accessories 2701

Cylinder accessory set consisting of external cylinder ring for Scandinavian oval cylinder and internal thumbturn.

Cylinder accessories are supplied with cylinder rings in heights from 6 to 21 mm including 2 pcs. M5 x 75 mm screws, follower and cylinder screws.

Centre distance with 30 mm.

Ruko-Line is manufactured in satin stainless steel grade AISI 316L.

Article No.	Ref. No.	Description
951400	2701-9906	Cylinder accessories with thumbturn and 6 mm cylinder ring
951401	2701-9908	Cylinder accessories with thumbturn and 8 mm cylinder ring
951402	2701-9911	Cylinder accessories with thumbturn and 11 mm cylinder ring
951403	2701-9913	Cylinder accessories with thumbturn and 13 mm cylinder ring
951404	2701-9916	Cylinder accessories with thumbturn and 16 mm cylinder ring
951405	2701-9918	Cylinder accessories with thumbturn and 18 mm cylinder ring
951406	2701-9921	Cylinder accessories with thumbturn and 21 mm cylinder ring





Cylinder accessories 2702

Cylinder accessory set consisting of external cylinder ring for Scandinavian oval cylinder and internal disabled thumbturn.

Cylinder accessories are supplied with cylinder rings in heights from 6 to 21 mm including 2 pcs. M5 x 75 mm screws, follower and cylinder screws.

The cylinder accessories are supplied with 30 mm centre.

Ruko-Line is manufactured in satin stainless steel grade AISI 316L.



Article No.	Ref. No.	Description
951407	2702-9906	Cylinder accessories with thumbturn and 6 mm cylinder ring
951408	2702-9908	Cylinder accessories with thumbturn and 8 mm cylinder ring
951409	2702-9911	Cylinder accessories with thumbturn and 11 mm cylinder ring
951410	2702-9913	Cylinder accessories with thumbturn and 13 mm cylinder ring
951411	2702-9916	Cylinder accessories with thumbturn and 16 mm cylinder ring
951412	2702-9918	Cylinder accessories with thumbturn and 18 mm cylinder ring
951413	2702-9921	Cylinder accessories with thumbturn and 21 mm cylinder ring



Cylinder accessories 3502

Cylinder accessory set consisting of external cylinder ring and internal rokoko cylinder ring for Scandinavian oval cylinder.

Cylinder accessories are supplied with cylinder rings in heights from 6 to 21 mm including 2 pcs. M5 x 75 mm screws and cylinder screws.

Centre distance 30 mm.

Ruko-Line is manufactured in satin stainless steel grade AISI 316L.



Article No.	Ref. No.	Description
951430	3502-9106	Cylinder accessories with 6 mm cylinder rings
951431	3502-9108	Cylinder accessories with 8 mm cylinder rings
951432	3502-9111	Cylinder accessories with 11 mm cylinder rings
951433	3502-9113	Cylinder accessories with 13 mm cylinder rings
951434	3502-9116	Cylinder accessories with 16 mm cylinder rings
951435	3502-9118	Cylinder accessories with 18 mm cylinder rings
951436	3502-9121	Cylinder accessories with 21 mm cylinder rings

Cylinder escutcheons DIN 2901

Pair of cylinder escutcheons consisting of external and internal cylinder escutcheon suitable for EURO profile cylinder.

Cylinder escutcheons are supplied with either 2 pcs. M5 x 75 mm screws or 4 pcs. 16 mm wood screws.

Centre distance 38 mm.

Ruko-Line is manufactured in satin stainless steel grade AISI 316L.



Article No.	Ref. No.	Description
951537	2901-0138	Pair of cylinder escutcheons for EURO profile cylinder with M4 x 75 mm screws
951538	2901-0238	Pair of cylinder escutcheons for EURO profile cylinder with wood screws

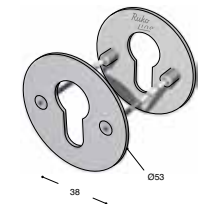



Narrow style cylinder escutcheon 2902

Cylinder escutcheon suitable for Scandinavian oval cylinder.

Centre distance 60 mm.

Supplied with 2 pcs. M4 x 75 mm screws.

Ruko-Line is manufactured in satin stainless steel grade AISI 316L.

Article No.	Ref. No.	Description
951816	2902-0360	Cylinder escutcheon for oval cylinder

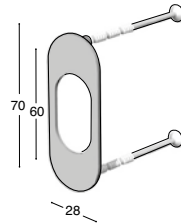

Narrow style cylinder escutcheon 2902

Cylinder escutcheon suitable for DIN/EURO profile cylinder.

Centre distance 50 mm.

Supplied in pairs with 2 pcs. M4 x 75 mm screws or 4 pcs. wood screws.

Ruko-Line is manufactured in satin stainless steel grade AISI 316L.

Article No.	Ref. No.	Description
951817	2902-0150	Cylinder escutcheon for DIN cylinder. Supplied with 2 pcs. M4 x 75 mm screws

Article No.	Ref. No.	Description
951818	2902-0250	Cylinder escutcheon for DIN cylinder. Supplied with 4 pcs. wood screws

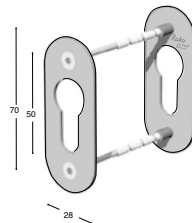

Toilet indicator set 3002-0130

Toilet indicator set for Connect and modular lock cases.

Toilet indicator set with external red/white indication and emergency release and internal thumbturn.

The toilet indicator sets are suitable for door thickness 40 to 50 mm and supplied with 2 pcs. M4 x 75 mm screws and follower.

Centre distance 30 mm.

Ruko-Line is manufactured in satin stainless steel grade AISI 316L.

Article No.	Ref. No.	Description
951542	3002-0130	Toilet indicator set, 30 mm centre

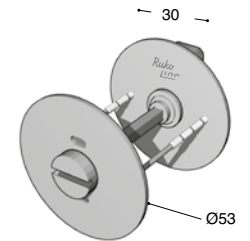

Toilet indicator set 3002-0127

Toilet indicator set for Boda 2014 lock cases or similar.

Toilet indicator set with external red/white indication and emergency release and internal thumbturn.

The toilet indicator sets are suitable for door thickness 40 to 50 mm and supplied with 2 pcs. M4 x 75 mm screws and follower.

Centre distance 27 mm.

Ruko-Line is manufactured in satin stainless steel grade AISI 316L.

Article No.	Ref. No.	Description
951543	3002-0127	Toilet indicator set, 27 mm centre

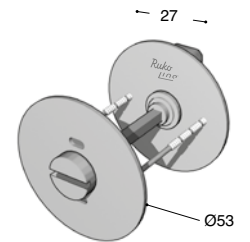



Disabled toilet indicator set 3003-0138

Toilet indicator set for DIN/EURO lock cases.

Centre distance 38 mm. Door thickness 40 to 50 mm.

Supplied with 2 pcs M4 x 75 mm screws.

Ruko-Line is manufactured in satin stainless steel grade AISI 316L.

Article No.	Ref. No.	Description
951547	3003-0138	Toilet indicator set disabled, 38 mm centre

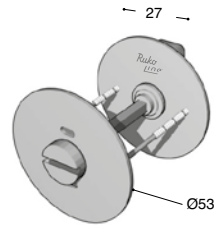

Back plates 52 mm

This applies to all Back plates 52 mm:

- Back plates are supplied without fixing screws.
- Ruko-Line is manufactured in satin stainless steel grade AISI 316L.

Blind plate 5201-0100

- Blind plate for doors where lever handle, cylinder or thumbturn is not required.
- Size: 52 x 206 x 2 mm.



Blind plate 5201-0100

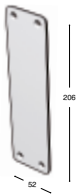

Back plate 5202-0100

- Back plate with hole for lever handle. Fits Connect and modular lock cases.
- Size: 52 x 206 x 2 mm.



Back plate 5202-0100

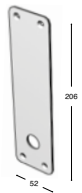

Back plate 5203-0105

- Back plate with hole for Scandinavian oval cylinder and lever handle. Fits Connect and modular lock cases.
- Size: 52 x 206 x 2 mm. Centre distance 105 mm.



Back plate 5203-0105



Back plate 5232-0105

- Back plate with thumbturn and hole for lever handle. Fits Connect and modular lockcases.
- Size: 52 x 206 x 2 mm. Centre distance 105 mm.
- The back plate is supplied with cylinder screws M5 x 28 and follower.



Back plate 5232-0105

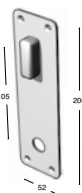

Back plate 5233-0105

- Back plate with disabled thumbturn and hole for lever handle. Fits Connect and modular lockcases.
- Size: 52 x 206 x 2 mm. Centre distance 105 mm.
- The back plate is supplied with cylinder screws M5 x 28 and follower.



Back plate 5233-0105





Back plates 52 mm

This applies to all Back plates 52 mm:

- Back plates are supplied without fixing screws.
- Ruko-Line is manufactured in satin stainless steel grade AISI 316L.

Back plate 5230-0105

- Back plate with red/white indicator, emergency release and hole for lever handle. Fits Connect and modular lock cases.
- Size: 52 x 206 x 2 mm. Centre distance 105 mm.
- To be used with interior back plate 5232-0105 or 5233-0105.
- The back plate is supplied with 5 x 5 mm spindle and follower.



Back plate 5230-0105

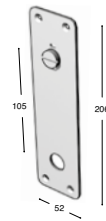

Back plate 5206-0100

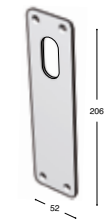

Back plate 5206-0100

- Back plate with hole for Scandinavian oval cylinder. Fits Connect and modular lock cases.
- Size: 52 x 206 x 2 mm.
- Back plate with hole for cylinder and lever handle. Fits DIN/EURO lock cases.
- Size: 52 x 206 x 2 mm. Centre distance 72 or 92 mm.

Back plate 5205

- Back plate with hole for cylinder. Fits DIN/EURO lock cases.
- Size: 52 x 206 x 2 mm. Centre distance 72 or 92 mm.



Back plate 5205

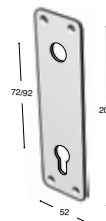

Back plate 5208

- Back plate with hole for cylinder. Fits DIN/EURO lock cases.
- Size: 52 x 206 x 2 mm. Centre distance 72 or 92 mm.



Back plate 5208

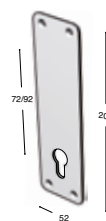

Back plates 60 mm

This applies to all Back plates 60 mm:

- Back plates are supplied without fixing screws.
- Ruko-Line is manufactured in satin stainless steel grade AISI 316L.

Blind plate 6001-0100

- Blind plate for doors where lever handle, cylinder or thumbturn is not required.
- Size: 60 x 206 x 2 mm.



Blind plate 6001-0100

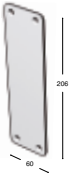

Back plate 6002-0100

- Back plate with hole for lever handle. Fits Connect and modular lock cases.
- Size: 60 x 206 x 2 mm.



Back plate 6002-0100

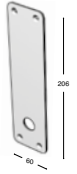

Back plate 6004-0111

- Back plate with hole for Scandinavian Ø40 cylinder and lever handle. Fits Connect and modular lock cases.
- Size: 60 x 206 x 2 mm. Centre distance 105 mm.



Back plate 6004-0111

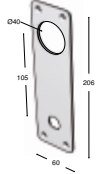

Back plate 6007-0100

- Back plate with hole for Scandinavian Ø40 cylinder. Fits Connect and modular lock cases.
- Size: 60 x 206 x 2 mm. Centre distance 105 mm.



Back plate 6007-0100

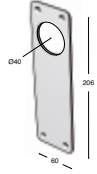

Back plate 6012-0105

- Back plate with thumbturn and hole for lever handle. Fits Connect and modular lock cases.
- Size: 60 x 206 x 2 mm. Centre distance 105 mm.
- The back plate is supplied with 2 pcs M5 x 28 cylinder screws and follower



Back plate 6012-0105

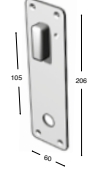

Back plate 6013-0105

- Back plate with disabled thumbturn and hole for lever handle. Fits Connect and modular lock cases.
- Size: 60 x 206 x 2 mm. Centre distance 105 mm.
- Back plates are supplied without fixing screws.



Back plate 6013-0105





Back plates 60 mm

This applies to all Back plates 60 mm:

- Back plates are supplied without fixing screws.
- Ruko-Line is manufactured in satin stainless steel grade AISI 316L.

Back plate 6030-0105

- Back plate with red/white indicator, emergency release and hole for lever handle. Fits Connect and modular lock cases.
- To be used with internal back plates 6032-0105 and 6033-0105.
- Size: 60 x 206 x 2 mm. Centre distance 105 mm.
- The back plate is supplied with 5 x 5 mm spindle and follower.



Back plate 6030-0105

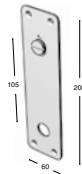

Back plate 6032-0105

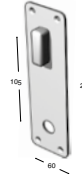

Back plate 6033-0105



Back plate 6032-0105

- Back plate with thumbturn and hole for lever handle. Fits Connect and modular lock cases.
- Size: 60 x 206 x 2 mm. Centre distance 105 mm.
- The back plate is supplied with 2 pcs M5 x 28 mm cylinder screws and follower.

Back plate 6033-0105

- Back plate with disabled thumbturn and hole for lever handle. Fits Connect and modular lock cases.
- Size: 60 x 206 x 2 mm. Centre distance 105 mm.
- The back plate is supplied with 2 pcs M5 x 28 mm cylinder screws and follower.

Back plate 6052-0100

- Back plate with thumbturn. Fits Connect and modular lock cases.
- Size: 60 x 206 x 2 mm.
- The back plate is supplied with 2 pcs M5 x 28 mm cylinder screws and follower.



Back plate 6052-0100



Back plate 6053-0100



Back plate 6053-0100

- Back plate with disabled thumbturn. Fits Connect and modular lock cases.
- Size: 60 x 206 x 2 mm.
- The back plate is supplied with 2 pcs M5 x 28 mm cylinder screws and follower.

Back plate 6090-0111

- Back plate with hole for Scandinavian Ø40 cylinder, thumbturn and hole for lever handle. Fits Connect and modular lock cases type 2002/2000.
- On exterior side, use back plate 6004-111 for cylinder and lever handle.
- Size: 60 x 206 x 2 mm. Centre distance 105 mm.
- The back plate is supplied with 5 x 5 mm spindle.



Back plate 6090-0111

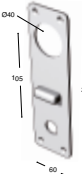

Back plates 32 mm

This applies to all Back plates 32 mm:

- Ruko-Line is manufactured in satin stainless steel grade AISI 316L.

Narrow style back plate 6405

- Pair of narrow style back plates. Fits narrow style DIN/EURO lock cases.
- Size 32 x 230 x 2 mm. Centre distance 72 or 92 mm.
- Supplied with 3 pcs M4 x 75 mm screws.



Narrow style back plate 6405

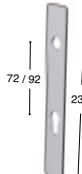

Narrow style back plate 6408

- Pair of narrow style back plates. Fits narrow style DIN lock cases.
- Size 32 x 230 x 2 mm. Centre distance 72 or 92 mm.
- Supplied with 3 pcs M4 x 75 mm screws.



Narrow style back plate 6408

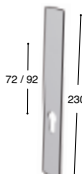

Narrow style blind plate 6201-0100

- Narrow style external blind plate. Fits ASSA narrow style lock cases 1360 series.
- Size 32 x 230 x 2 mm.
- Supplied with 3 pcs. M5x75 mm through going screws



Narrow style blind plate 6201-0100

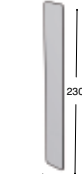

Narrow style blind plate 6201-0101

- Narrow style internal blind plate. Fits ASSA narrow style lock cases 1360 series.
- Size 32 x 230 x 2 mm.
- Supplied without screws.



Narrow style blind plate 6201-0101



Narrow style back plate 6202-0100

- Narrow style external back plate with hole for lever handle. Fits ASSA narrow style lock cases 1360 series.
- Size 32 x 230 x 2 mm.
- Supplied with 3 pcs. M5 x 75 mm through going screws



Narrow style back plate 6202-0100

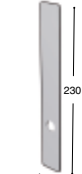

Narrow style back plate 6202-0101

- Narrow style internal back plate with hole for lever handle. Fits ASSA narrow style lockcases 1360 series.
- Size 32 x 230 x 2 mm.
- Supplied without screws.



Narrow style back plate 6202-0101





Back plates 32 mm

This applies to all Back plates 32 mm:

- Ruko-Line is manufactured in satin stainless steel grade AISI 316L.

Narrow style back plate 6288

- Narrow style internal back plate with hole for Scandinavian rokokko cylinder and lever handle. Fits ASSA narrow style lock cases 1360 series.
- Size 32 x 230 x 2 mm. Centre distance 115 mm.
- Supplied without screws.

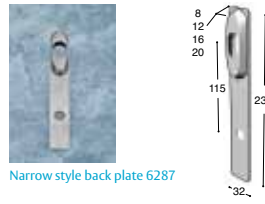

Narrow style back plate 6287

- Narrow style external back plate with hole for Scandinavian oval cylinder and lever handle. Fits ASSA narrow style lock cases 1360 series.
- Size 32 x 230 x 2 mm. Centre distance 115 mm.
- Supplied with 3 pcs. M5 x 75 mm screws.



Narrow style back plate 6231-0105

- Narrow style internal back plate with thumbturn and hole for lever handle. Fits ASSA narrow style lock cases 1360 series.
- Size 32 x 230 x 2 mm. Centre distance 115 mm.
- Supplied without screws.



Narrow style back plate 6286

- Narrow style internal back plate with hole for Scandinavian rokokko cylinder. Fits ASSA narrow style lock cases 1360 series.
- Size 32 x 230 x 2 mm. Centre distance 115 mm.
- Supplied without screws.



Narrow style back plate 6285

- Narrow style external back plate with hole for Scandinavian oval cylinder. Fits ASSA narrow style lock cases 1360 series.
- Size 32 x 230 x 2 mm. Centre distance 115 mm.
- Supplied with 3 pcs. M5 x 75 mm screws.



Narrow style back plate 6272-0100

- Narrow style internal back plate with thumbturn. Fits ASSA narrow style lock cases 1360 series.
- Size 32 x 230 x 2 mm. Centre distance 115 mm.
- Supplied without screws.



Back plates 32 mm

This applies to all Back plates 32 mm:

- Ruko-Line is manufactured in satin stainless steel grade AISI 316L.

Narrow style blind plate 6301-0100

- Narrow style external blind plate. Fits Connect narrow style lock cases.
- Size 32 x 230 x 2 mm. Centre distance 105 mm.
- Supplied with 2 pcs. M5 x 75 mm through going screws.



Narrow style blind plate 6301-0101

- Narrow style internal blind plate. Fits Connect narrow style lock cases.
- Size 32 x 230 x 2 mm. Centre distance 105 mm.
- Supplied without screws.



Narrow style back plate 6302-0100

- Narrow style external back plate with hole for lever handle. Fits Connect narrow style lock cases.
- Size 32 x 230 x 2 mm. Centre distance 105 mm.
- Supplied with 2 pcs. M5 x 75 mm through going screws.



Narrow style back plate 6302-0101

- Narrow style internal blind plate with hole for lever handle. Fits Connect narrow style lock cases.
- Size 32 x 230 x 2 mm. Centre distance 105 mm.
- Supplied without screws.



Narrow style back plate 6388

- Narrow style internal back plate with hole for Scandinavian rokokko cylinder. Fits Connect narrow style lock cases.
- Size 32 x 230 x 2 mm. Centre distance 105 mm.
- Supplied without screws.





Back plates 32 mm

This applies to all Back plates 32 mm:

- Ruko-Line is manufactured in satin stainless steel grade AISI 316L.

Narrow style back plate 6387

- Narrow style external back plate with hole for Scandinavian oval cylinder. Fits Connect narrow style lock cases.
- Size 32 x 230 x 2 mm. Centre distance 105 mm.
- Supplied with 2 pcs. M5 x 75 mm screws.



Narrow style back plate 6387

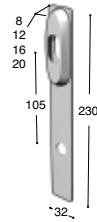

Narrow style back plate 6331-0105

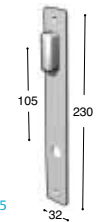

Narrow style back plate 6331-0105

- Narrow style internal back plate with thumbturn and hole for lever handle. Fits Connect narrow style lock cases.
- Size 32 x 230 x 2 mm. Centre distance 105 mm.
- Supplied without screws.



Narrow style back plate 6386

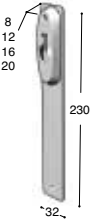

Narrow style back plate 6386

- Narrow style internal back plate with hole for Scandinavian rokoko cylinder. Fits Connect narrow style lock cases.
- Size 32 x 230 x 2 mm. Centre distance 105 mm.
- Supplied without screws.



Narrow style back plate 6385

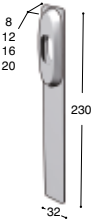

Narrow style back plate 6385

- Narrow style external back plate with hole for Scandinavian oval cylinder. Fits Connect narrow style lock cases.
- Size 32 x 230 x 2 mm. Centre distance 105 mm.
- Supplied with 2 pcs. M5 x 75 mm screws.



Narrow style back plate 6372-0100

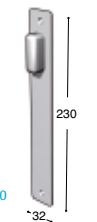

Narrow style back plate 6372-0100

- Narrow style internal back plate with thumbturn. Fits Connect narrow style lock cases.
- Size 32 x 230 x 2 mm. Centre distance 105 mm.
- Supplied without screws.



Square plates

This applies to all Square plates:

- Square plates are supplied without fixing screws.
- Ruko-Line is manufactured in satin stainless steel grade AISI 316L.

Square plate 6501-0100

- Blind plate for doors where lever handle, cylinder or thumbturn is not required.
- Size: 170 x 175 x 2 mm.



Square plate 6501-0100



Square plate 6502

- Square plate with hole for lever handle. Fits Connect and modular lock cases.
- Size: 170 x 175 x 2 mm.
- Square plates are handed.

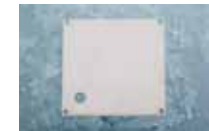

Square plate 6502

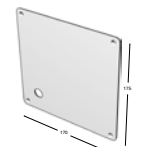

Square plate 6504

- Square plate with hole for Scandinavian Ø40 cylinder and lever handle. Fits Connect and modular lock cases.
- Size: 170 x 175 x 2 mm. Centre distance 105 mm.
- Square plates are handed.



Square plate 6504



Square plate 6512

- Square plate with thumbturn and hole for lever handle. Fits Connect and modular lock cases.
- Size: 170 x 175 x 2 mm. Centre distance 105 mm.
- The square plate is supplied with 2 pcs M5 x 28 mm cylinder screws and follower.
- Square plates are handed.



Square plate 6512

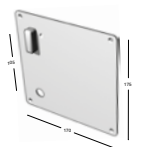



Square plates

This applies to all Square plates:

- Square plates are supplied without fixing screws.
- Ruko-Line is manufactured in satin stainless steel grade AISI 316L.

Square plate 6513

- Square plate with disabled thumbturn and hole for lever handle. Fits Connect and modular lock cases.
- Size: 170 x 175 x 2 mm. Centre distance 105 mm.
- The square plate is supplied with 2 pcs M5 x 28 mm cylinder screws and follower.
- Square plates are handed.



Square plate 6513

Square plate 6530

- Square plate with red/white indicator, emergency release and hole for lever handle. Fits Connect and modular lock cases.
- Size: 170 x 175 x 2 mm. Centre distance 105 mm.
- To be used with external square plate 6532 or 6533.
- The square plate is supplied with 5 x 5 mm spindle and follower.
- Square plates are handed.



Square plate 6530

Square plate 6532

- Square plate with thumbturn and hole for lever handle. Fits Connect and modular lock cases.
- Size: 170 x 175 x 2 mm. Centre distance 105 mm.
- The square plate is supplied with 2 pcs M5 x 28 mm cylinder screws and follower.
- Square plates are handed.



Square plate 6532

Square plate 6533

- Square plate with disabled thumbturn and hole for lever handle. Fits Connect and modular lock cases.
- Size: 170 x 175 x 2 mm. Centre distance 105 mm.
- The square plate is supplied with 2 pcs M5 x 28 mm cylinder screws and follower.
- Square plates are handed.



Square plate 6533



Door stops

This applies to all Door stops:

- Door stops are supplied without fixing screws.
- Ruko-Line is manufactured in satin stainless steel grade AISI 316L.

Door stop 9001-0145

- Floor door stop with black rubber buffer.
- Height: 45 mm



Door stop 9001-0145

Door stop 9001-0185

- Wall door stop with black rubber buffer.
- Height: 85 mm



Door stop 9001-0185

Door stop 9003-0115

- Floor door stop with black rubber buffer.
- Height: 15 mm

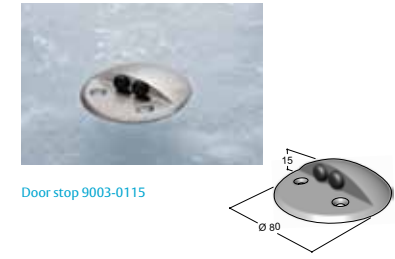

Door stop 9003-0115

Door stop 9003-0130

- Floor door stop with black rubber buffer.
- Height: 30 mm

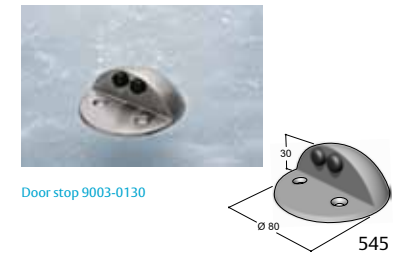

Door stop 9003-0130



Pull handles

This applies to all Pull handles:

- Pull handles are supplied with screws and glass door accessories.
- Ruko-Line is manufactured in satin stainless steel grade AISI 316L.

Pull handle 7016

- Pair of straight pull handles for door thickness 10 - 70 mm.
- Size: 16 mm diameter x 125 mm centre distance.



Pull handle 7016



Pull handle 7019



Pull handle 7019

- Straight pull handle for door thickness 10 - 70 mm.
- Size: 19 mm diameter x 300 mm centre distance.



Pull handle 7119

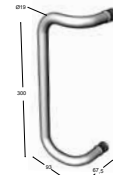

Pull handle 7119

- Cranked pull handles for door thickness 10 - 70 mm.
- Size: 19 mm diameter x 300 mm centre distance.



Pull handle 7025



Pull handle 7025

- Straight pull handle for door thickness 10 - 70 mm.
- Size: 25 mm diameter x 300 mm centre distance.



Pull handle 7125

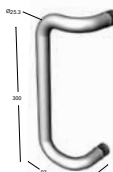

Pull handle 7125

- Cranked pull handles for door thickness 10 - 70 mm.
- Size: 25 mm diameter x 300 mm centre distance.



Pull handle 7032



Pull handle 7032

- Straight pull handle for door thickness 10 - 70 mm.
- Size: 32 mm diameter x 300 mm centre distance.



Pull handles

This applies to all Pull handles:

- Pull handles are supplied with screws and glass door accessories.
- Ruko-Line is manufactured in satin stainless steel grade AISI 316L.

Pull handle 7032

- Straight pull handles for door thickness 10 - 70 mm.
- Size: 32 mm diameter x 650 mm centre distance.



Pull handle 7032

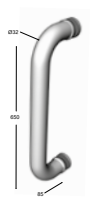

Pull handle 7132

- Cranked pull handle for door thickness 10 - 70 mm.
- Size: 32 mm diameter x 300 mm centre distance.



Pull handle 7132

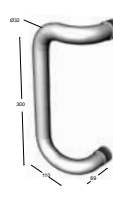

Pull handle 7132

- Cranked pull handle for door thickness 10 - 70 mm.
- Size: 32 mm diameter x 650 mm centre distance.



Pull handle 7132

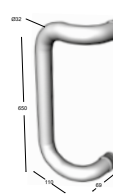

Pull handle 7232

- Circular pull handle for door thickness 10 - 70 mm.
- Size: 32 mm diameter x 300 mm centre distance.



Pull handle 7232



Pull handle 7232

- Circular pull handle for door thickness 10 - 70 mm.
- Size: 32 mm diameter x 400 mm centre distance.



Pull handle 7232

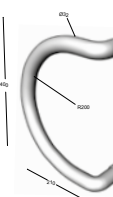

REGISTER

TILL GALLERI 2



SKNING

RE





ALPHANUMERIC INDEX

1

1201, 1205, 1206, Coupling hinges 450
1212, 1212-01, Lift-off hinges 438
1222, Lift-off hinges 438
1223-100, 1223-85, Lift-off hinges 439
1228, Lift-off hinges 438
1296, 1396, Flush bolt 458
130, 131, Pull handles, single 132
137, 138, Pull handles, double 134
1592, 2592, Cabinet locks 239
167, Turn knob 130
18 256 DIN, Cylinder accessories for ASSA Euro profile cylinders 121
18 256RF, Cylinder accessories for oval cylinders-stainless steel 140
1903, Sprung lever handles, Epok series 114
1905, Unsprung lever handles, Epok series 112
1918, Sprung lever handles, Epok series 110
1923, Unsprung lever handles, Epok series 112
1927, Sprung lever handles, Epok series 114
1930, Sprung lever handles, Epok series 110
1935, Unsprung lever handles, Epok series 113
1937, Sprung lever handles, Epok series 115
1949, Unsprung lever handles, Epok series 113
1956, Sprung lever handles, Epok series 111

2

211-65, Coupling hinges 449
2220, 2228, 2248, Spring hinges 455
22CL 374
2301, Accessories hinges 456
2302, Accessories hinges 456
2396, Flush bolt 458
2403, 2434, 2465, Mounting plates 452
240IR 378
2418, Lift-off hinges 439
2419, Mounting plates 453
2439, 2441, 2459, Mounting plates 453
2465 fire, Mounting plates 452
2466, Spring hinges 455
248, Accessories hinges 456
249, Accessories hinges 456
256, 2256, 2256 RC, 2356, 9256, 18256 138
25CL 376
265, 265E, 5265, 9265, 95265, 9565T, 9565T2, 9566T2 146
270NB, Vehicle tag without button 365
270NBE 365

270NBE, Vehicle booster for Prox card 365
270NBS, Vehicle tag with button 365
270NCBE, Vehicle booster combi for Prox card 365
270NMMW 363
279, 280, Spring hinges 454
2800, 2860, 2861, 2862, 2863, 2864, 2865, 2866, 2876, 2885, 2887, 2888, 2892, Strike plate 246
2866-1, 2866-2, 2876-1, 2876-5, 2892-5, 2892-6, Strike plate 247

3

3012, Journal-supported lift-off hinges 448
3210, Journal-supported lift-off hinges 440
3211-1, Journal-supported lift-off hinges 441
3212, Journal-supported lift-off hinges 441
3220, Journal-supported lift-off hinges 440
3225, Journal-supported lift-off hinges 446
3228, Journal-supported lift-off hinges 442
3228-554, Journal-supported lift-off hinges 442
3229, Journal-supported lift-off hinges 444
3232, Journal-supported lift-off hinges 444
3240, Journal-supported lift-off hinges 445
3241, Journal-supported lift-off hinges 445
3244, Journal-supported lift-off hinges 443
3248, Journal-supported lift-off hinges 443
325, 326, Pull handles, double 134
3278, Journal-supported lift-off hinges 447
3288, Journal-supported lift-off hinges 448
3881, Coupling hinges 450
3-point locks 2565, 6498 228

4

4159, 4359, 4359 RC, 4459, 4459 RC, Cylinder accessories for Classic narrow profile locks 154
4218, 4318, 4256, 4356, Decorative backplates, Epok series 152
4218/4318, Decorative backplates, Epok series 152
4256 RF/4356 RF, Decorative backplates, stainless steel, Epok series 151
4256/4356, Decorative backplates, Epok series 152
4265, Cover plates for modular locks 149
4289, Cover plate 150
4290, Door reinforcements, Modular 153
4292, Door reinforcements, Modular 153
44159, 44459, S3 cylinder accessories for Classic narrow profile locks 158
44159E, 44459E, S4 cylinder accessories for Connect narrow profile locks 160
44859, 44959, S3 cylinder accessories

for Classic narrow profile locks 158
44859E, 44959E, S4 cylinder accessories for Connect narrow profile locks 160
4559, 4559 RC, 4659, 4659 RC, 4759, Security accessories for Connect narrow profile locks 162
4559E, 4559E RC, 4659E, 4659E RC, 4759E, 4759E RC, 5559E, 5559E RC, 5659E, 5659E RC, 5759E 163
4859, 4959, Cylinder accessories for Classic narrow profile locks 154
496, Pull knob 130

5

5000, 5001, 5002, Coupling hinges 449
5059, 5159, 5359, 5359 RC, 5459, 5459 RC, Cylinder accessories for Classic narrow profile locks 155
540, Accessories hinges 456
5485EM 334
55059, 55159, 55459, S3 cylinder accessories for Classic narrow profile locks 159
55059E, 55159E, 55459E, S4 cylinder accessories for Connect narrow profile locks 161
55859, 55959, S3 cylinder accessories for Classic narrow profile locks 159
55859E, 55959E, S4 cylinder accessories for Connect narrow profile locks 161
5602, Unsprung lever handles, Classic 121
5614, Unsprung lever handles, Classic 121
5859, 5959, Cylinder accessories for Classic narrow profile locks 155
593, 1593, 2593, 3593, Cabinet locks 239

6

6416 307
6300/6304 306
6354M 350
6355M 349
64, 4291, 4291:1, 4294, 4295, Cover/thumbturn plates 150
640, Unsprung lever handles, Classic 120
6480EM/6481EM 338
6485EM 336
6540KS, Snap-In hinges 451
6616, Sprung lever handle, Classic 117
6638, Sprung lever handle, Classic 119
6640, Sprung lever handle, Classic 116
6647, Sprung lever handle, Classic 118
6655, Sprung lever handle, Classic 118
6696, Sprung lever handle, Classic 117
696, Unsprung lever handles, Classic 120

7

7287, Push button cylinder 482
7585MF 332
7801, 7802, 7811, 7812, 7902, 7912, Espagnolette handles 131

8

8561 144
810C-50, 811C-50 287
8256RF, 2256RF, 2356RF, Cylinder accessories for oval cylinders-stainless steel 140
8362, Opening accessories for Classic narrow profile locks 156
84559, 84559 RC, 84659, 84659 RC, 84759, 84759 RC, Opening device for Classic narrow profile motor locks 166
8630, 8631, Pull handles, stainless steel 133
865, 866, 867, Unsprung lever handle with needle bearing, stainless steel 125
8650, 8665, 8670, 8680, 8685, 8690, Sprung lever handle with needle bearing, stainless steel 125
880, 881, 884, 885, 886, Solenoid Handle Locks 284
8812, ASSA ABLOY Code Handle Door, electromechanical code handle for innerdoors 126

9

91013D3A 304
9101D3 304
9101R4850 304
9101RC64 304
911-35 Connect, 911-50 Connect 486
96, Flush bolt 457
97, Flush bolt 457
992, Cover plates for modular locks 149

ALPHABETICAL REGISTER

A

ABLOY pushbutton cylinder 482
Accessories 3325 and 3425 for panic exit devices ASSA 1125 and 1130 171
Accessories for ASSA 1200 and ASSA 1500 424
Accessories for readers 351
Accessories hinges 456
Accessory sets 5761-1 and 5761-3 for double cylinder lock 139
Addion® - Reduces the risk of bacteria spread 108

Angle plate 802 424
Aperio C900S off line 355
Aperio E900S off line 356
Aperio PAP Tool 362
Arena U, Sprung lever handle, Classic 116
ARX Access control system 100
ARX system overview 103
ASSA 1150-series, Panic Panic devices, Rim model 180
ASSA 1160-series, Panic Panic devices, Rim model 181
ASSA 1200 423
ASSA 131, 5131, 8131, 331, 5331, 8331 264
ASSA 14, 514, 114, 5114, Electric strikes 274
ASSA 1500 423
ASSA 2020 Latch lock 489
ASSA 2530 Panic strike plate for passive 175
ASSA 2820 and 2830 480
ASSA 2970/3970/5970 500
ASSA 3000 423
ASSA 309 Connect 487
ASSA 40C and 40T Dead bolt locks 489
ASSA 41, 42, 43, Magnet contact 294
ASSA 505, 507, 510, 510T, 511, 511T, 512, 520, 521, 528, Faceplates for ASSA electric strikes, medium-security 276
ASSA 540, 541, 542, 543, Faceplates for SapaFront profile systems 278
ASSA 5816 473
ASSA 585 268
ASSA 716 473
ASSA 725, Faceplates 272
ASSA 730, 730T*, Faceplates 272
ASSA 731/17, 731/20, 731/26, Faceplates 273
ASSA 7311 470
ASSA 7312 472
ASSA 732, 732T*, Faceplates 273
ASSA 733/17, 733/20, 733/26, Faceplates 273
ASSA 7343 471
ASSA 735, Faceplates 273
ASSA 737, Faceplates 273
ASSA 740, 741, 742, 743, 745, 746, 747, Faceplates 273
ASSA 740, 741, 742, 743, Faceplates for SapaFront profile systems 278
ASSA 75, 575, 70, 570, 71, 571, Electric strikes, standard-security 270
ASSA 750, Faceplates 273
ASSA 805 483
ASSA 811 483
ASSA 816, 823, 824, 830, 830T 266
ASSA 82, 876, 877, 878, 8400, 8410 293

ASSA 83 291
ASSA 840, 841, 842, 843, Faceplates for SapaFront profile systems 278
ASSA 900 Multi 262
ASSA 900, 910, 911, 920 262
ASSA 910 Fail secure (locked) 262
ASSA 910-35 Connect, 910-50 Connect 486
ASSA 911 Fail safe (unlocked) 262
ASSA 920 Fire rated E/EI 60 Fail secure 262
ASSA ABLOY Code Handle Door Long Plate, electromechanical code handle for doors 128
ASSA ABLOY Code Handle Door, electromechanical code handle for innerdoors 126
ASSA ABLOY D10 384
ASSA ABLOY D15 386
ASSA ABLOY DA85 418
ASSA ABLOY DA85, Door operator 418
ASSA ABLOY DC200 388
ASSA ABLOY DC300 390
ASSA ABLOY DC475 414
ASSA ABLOY DC500 394
ASSA ABLOY DC640 404
ASSA ABLOY DC700 398
ASSA ABLOY Door closer 382
ASSA ABLOY floor springs 414
ASSA Blue padlock 83
ASSA CLIQ Remote 64
ASSA CLIQ Web Manager 96
ASSA Code Handle, electromechanical handle 474
ASSA DA7051 and DA7052, Radar 420
ASSA DA8550 and DA8558, Elbow switches 420
ASSA DA8555 and DA8556, Presence device input 421
ASSA DK, Pull cord switch 421
ASSA dp 2400 71
ASSA dp 4400 70
ASSA dp CLIQ 68
ASSA dp Tronic 62
ASSA E-Lite 497
ASSA finishes, Addion® 106
ASSA finishes, Brown anodised 107
ASSA finishes, Nickel 106
ASSA finishes, Polished brass 107
ASSA finishes, Polished chrome 106
ASSA finishes, Prion® 106
ASSA finishes, Satin brass 107
ASSA finishes, Satin chrome 107
ASSA finishes, Satin steel 107
ASSA Green padlock 82
ASSA KSS, key switch 422
ASSA Lock Spray 86





Register

Lock case 772-50, -70, Connect lock case for panic exit device ASSA 1125	173	Mortice, narrow profile locks	257
Lock case Connect	216	Mortice, strike plate 1487	258
Lock case part names	190	Mortice, strike plate 1887	259
Lock case, Accessories, Connect	195	Mounting plates	452
Lock case, Accessories, Connect narrow profile locks	196	Multi-point door lock	466
Lock case, Accessories, extra locks/narrow profile locks	193	N	
Lock case, Accessories, modular locks	192	Narrow profile locks	235
Lock case, Accessories, narrow profile locks	194	Nomenclature hinges	428
Lock case, Accessories, narrow profile locks	197	O	
Lock case, Microswitch functions, Connect	200	Off line in ARX	354
Lock case, Strike plate matrix, Connect	198	On line door leaf reader	322
Lock case, Strike plate matrix, modular locks	199	Opening accessories for Classic narrow profile locks	156
Lock function, Connect, Entrance and interior doors	205	Opening accessories for Classic narrow profile locks	157
Lock function, Connect, Entrance and perimeter protection	204	Opening device 84562, for Classic	165
Lock function, Connect, Split spindle	208	Opening device 84562E, for Connect	165
Lock function, modular lock, Entrance and perimeter protection	209	Opening device accessories for Modular locks	145
Lock function, modular locks, Entrance and interior doors	210	Opening device accessories, Modular	144
Lock function, modular locks, Narrow profile lock	214	Opening device accessories, 8560, 8560:2, 8560:4	144
Lock function, modular locks, Split spindle	213	Opening device accessory 8065	145
Locker hasps	496	Opening device for Classic narrow profile motor locks	166
Long range readers	363	Opening device for Connect/Classic narrow profile motor locks	165
		Opening device for modular locks, 8061	145
M		P	
M5600	466	Panic exit device 1125:1 and 1130:1	175
M5601	466	Panic exit device accessories	175
M5602	466	Panic exit device ASSA 1125	170
M5700	468	Panic exit device ASSA 1125:1	174
M5701	468	Panic exit device ASSA 1130	176
M5703	468	Panic exit device ASSA 1130:1	179
Magnet contact	294	Panic exit devices for Modular locks	170
Magnetic card readers with keypad	349	Panic exit devices for Modular locks with roses 0119	171
Magnetic cards	371	Panic exit devices for Modular locks	172
Medicine cabinet lock 1596	240	Panic exit devices for narrow profile and Modular locks	176
Mifare readers for encrypted sector reading	332	Panic exit devices for narrow profile and Modular locks	177
Miscellaneous accessories	168	Panic exit devices for narrow profile and Modular locks	179
Miscellaneous accessories	167	Panic Panic devices, Rim model	180
Miscellaneous locks	240	PCI10	348
Modular locks	224	PCI15	344
Mortice, Connect 35	250	PCI25	346
Mortice, Connect 50/70	251	Ruko-Line, Back plate 5206-0100	342
Mortice, modular locks 50/70	256	PCR40	340
		PCR45	340
		Protective diode	295



Register

Ruko-Line, Back plate 5233-0105	535	Ruko-Line, Narrow style back plate		Ruko-Line, Toilet indicator set	
Ruko-Line, Back plate 6002-0100	537	6231-0105	540	3002-0130	533
Ruko-Line, Back plate 6004-0111	537	Ruko-Line, Narrow style back plate		RX9016II	310
Ruko-Line, Back plate 6007-0100	537	6272-0100	540	RX9101	309
Ruko-Line, Back plate 6012-0105	537	Ruko-Line, Narrow style back plate 6285	540	S	
Ruko-Line, Back plate 6013-0105	537	Ruko-Line, Narrow style back plate 6286	540	S3 cylinder accessories for Classic narrow profile locks	158
Ruko-Line, Back plate 6030-0105	538	Ruko-Line, Narrow style back plate 6302-0100	541	S3 cylinder accessories for Classic narrow profile locks	159
Ruko-Line, Back plate 6032-0105	538	Ruko-Line, Back plate 6053-0100	538	S3 opening accessory for Classic 88362/S3 narrow profile locks	157
Ruko-Line, Back plate 6033-0105	538	Ruko-Line, Back plate 6090-0111	538	S4 cylinder accessories for Connect narrow profile locks	160
Ruko-Line, Back plate 6052-0100	538	Ruko-Line, Back plates 32 mm	539	S4 cylinder accessories for Connect narrow profile locks	161
Ruko-Line, Back plate 6053-0100	538	Ruko-Line, Back plates 32 mm	540	S4 opening accessory for Connect 88362E/S4 narrow profile locks	157
Ruko-Line, Back plate 6090-0111	538	Ruko-Line, Back plates 32 mm	541	Security accessories for Connect narrow profile locks	162
Ruko-Line, Back plates 32 mm	539	Ruko-Line, Back plates 52 mm	535	Security accessories for Connect narrow profile locks	163
Ruko-Line, Back plates 32 mm	540	Ruko-Line, Back plates 52 mm	536	Security device 8365 (self-locking)	483
Ruko-Line, Back plates 32 mm	541	Ruko-Line, Back plates 60 mm	537	Security device, triangular handle	483
Ruko-Line, Back plates 52 mm	542	Ruko-Line, Back plates 60 mm	538	Security strike plates 1487	241
Ruko-Line, Back plates 52 mm	535	Ruko-Line, Blind plate 5201-0100	535	Security strike plates	242
Ruko-Line, Back plates 52 mm	536	Ruko-Line, Blind plate 6001-0100	537	1489-11/1489-12	244
Ruko-Line, Back plates 52 mm	537	Ruko-Line, Coupé lever handle with roses 0319	526	Security strike plates 1887 and 1888	245
Ruko-Line, Back plates 60 mm	538	Ruko-Line, Coupé lever handle without roses 0319	526	Security strike plates 1889-11/1889-12	245
Ruko-Line, Blind plate 5201-0100	535	Ruko-Line, Cranked lever handle with narrow style roses 0419	524	Security strike plates, Connect	241
Ruko-Line, Blind plate 6001-0100	537	Ruko-Line, Cranked lever handle with roses 0419	525	Security strike plates, modular locks	244
Ruko-Line, Coupé lever handle with roses 0319	526	Ruko-Line, Cranked lever handle without roses 0419	524	Snap-In hinges	451
Ruko-Line, Coupé lever handle without roses 0319	526	Ruko-Line, Cylinder accessories 2701	529	Solenoid Handle Locks	284
Ruko-Line, Cranked lever handle with narrow style roses 0419	524	Ruko-Line, Cylinder accessories 2702	530	Spacer plate 4548	483
Ruko-Line, Cranked lever handle with roses 0419	525	Ruko-Line, Cylinder accessories 3502	531	Special locks	500
Ruko-Line, Cranked lever handle without roses 0419	524	Ruko-Line, Cylinder escutcheons DIN 2901	531	Spring hinges	454
Ruko-Line, Cylinder accessories 2701	529	Ruko-Line, Disabled toilet indicator set 3003-0138	534	Sprung lever handle with needle bearing, stainless steel	125
Ruko-Line, Cylinder accessories 2702	530	Ruko-Line, Door stop 9001-0185	545	Sprung lever handle, Classic	116
Ruko-Line, Cylinder accessories 3502	531	Ruko-Line, Door stop 9003-0115	545	Sprung lever handles, Epok series	110
Ruko-Line, Cylinder escutcheons		Ruko-Line, Door stop 9003-0130	545	Sprung lever handles, Epok series	114
DIN 2901	531	Ruko-Line, Door stops	545	ST60S	368
Ruko-Line, Pull handle 7019	546	Ruko-Line, Door stops 19 x 135 mm lever handle without roses 0819	527	Standard strike plates 1264-1 - 1264-8	243
Ruko-Line, Pull handle 7025	546	Ruko-Line, Hospital 19 x 155 mm lever handle without roses 0919	528	Standard strike plates, Connect	243
Ruko-Line, Pull handle 7032	546	Ruko-Line, Hospital 19 x 135 mm lever handle with roses 0819	527	Standard-security electric strikes Hi-O	268
Ruko-Line, Pull handle 7119	546	Ruko-Line, Hospital 19 x 155 mm lever handle with roses 0919	528	Strike plate	246
Ruko-Line, Pull handle 7125	546	Ruko-Line, Hospital 19 x 135 mm lever handle with roses 0819	527	Strike plate ASSA 545	280
Ruko-Line, Pull handle 7132	547	Ruko-Line, Hospital 19 x 155 mm lever handle with roses 0919	528	Strike plate location, Connect	253
Ruko-Line, Pull handle 7132	547	Ruko-Line, Narrow style back plate 6202-0100	539	Strike plates ASSA 546, 547	282
Ruko-Line, Pull handle 7232	547	Ruko-Line, Narrow style back plate 6202-0100	539	Surface-mounted locks	238
Ruko-Line, Pull handle 7232	547	Ruko-Line, Narrow style back plate 6202-0101	539		
Ruko-Line, Pull handles	546	Ruko-Line, Narrow style back plate		T	
Ruko-Line, Pull handles	547			Technical information for mounting on closing side,	
Ruko-Line, Square plate 6502	543			ASSA ABLOY G461/G462/G464	413
Ruko-Line, Square plate 6504	543				
Ruko-Line, Square plate 6512	543				
Ruko-Line, Square plates	543				
Ruko-Line, Square plates	544				

Register

Register

