

ABLOY® EL466, EL566
*Europrofile handle controlled
multipoint locks*



New **ABLOY®** multipoint locks are extension to the wide **ABLOY®** Europrofile electromechanical lock case range.

FUNCTION

The **ABLOY®** multipoint solenoid locks offer several functional options with comprehensive selection of status indications in one multipoint locking solution. In addition to increased security, they offer the same versatility as **ABLOY®** singlepoint solenoid lock cases do.

ABLOY® multipoint locks contain EL460/EL560 based main solenoid lock in the middle and two auxiliary locks with hook bolts. All three lock cases share the same forend and the locks are controlled by the main lock in the middle. Handle controlled locks can be set to function as fail locked or as fail unlocked. In the fail locked setting, the lock can be opened by handle when power is on, and it can not be opened by handle, when power is off. In the fail unlocked setting, the electrical function is the opposite.

ABLOY® EL566 and **ABLOY®** EL466

Only outside handle is electrically controlled. The lock can always be opened by inside handle and by cylinder.

ABLOY® EL567 and **ABLOY®** EL467

Both inside and outside handles are electrically controlled. Mechanical opening by cylinder or thumbturn is always possible.

APPLICATION

The locks are recommended to use in the interior doors of business premises, public buildings, hospitals etc. Typical applications are:

- Security doors (medium traffic)
- Fire doors (medium traffic)
- Other higher doors in e.g. storage rooms and technical maintenance rooms

EL566 and EL567 are used in wooden and metal doors. EL466 and EL467 are used in narrow profile doors. EL566 or EL466 with split spindle is chosen, when exit by handle is needed. EL567 or EL467 is chosen, when both access and exit are electrically controlled.

Handle controlled locks are best suited in medium traffic doors. The locks can be electrically controlled by access control system or by a remote control system such as timer, keypad or push button.

For high traffic doors we recommend **ABLOY®** motor locks.

The locks can be used in emergency exit, panic exit and fire rated doors (EN). The locks are not suitable for use with door automatics.

Also available:

- Microswitch locks
 - EL366 for wooden and metal doors
 - EL266 for narrow profile doors
- Mechanical locks
 - EL166 for wooden and metal doors
 - EL066 for narrow profile doors

Also available lock cases for Swiss cylinder (RZ):

- EL568 (split spindle), EL569 (through spindle) for wooden and metal doors
- EL468 (split spindle), EL469 (through spindle) for narrow profile doors
- EL368 microswitch lock for wooden and metal doors
- EL268 microswitch lock for narrow profile doors
- EL168 mechanical lock for wooden and metal doors
- EL068 mechanical lock for narrow profile doors

STANDARD DELIVERY

Lock case is delivered as fail locked.

Standard delivery includes: lock case, fixing screws etc, spindle adapters and installation manual.

Please specify when ordering: lock type, backset, forend length.

STANDARDS

EN STANDARDS

EN 179	Exit
EN 1125	Panic exit
EN 1634-1	Fire resistance
EN 61000-6-1	EMC
EN 61000-6-3	EMC
EN 12209	Mechanical resistance
EN14846	Electric Locks

Abloy lock cases are always tested according to the latest versions of the standards.



TECHNICAL DETAILS

Operating voltage:	12 – 24 V DC STAB (-10%, +15%)
Current:	Max. 0.4 A (12V DC), 0.17 A (24V DC), less than a second Idle 0.13 A (12V DC), 0.065 A (24V DC)
Micro switches:	Max. 0.5 A 30 V AC/DC resist, 10 W
Operating temperature:	-20°C - +60°C
Bolt throw:	20 mm (deadbolt), 10 mm (double action bolt)
Backset:	55, 60, 65, 80, 100 mm (EL566) 30, 35, 40, 45 mm (EL466)
Forend:	24 x 6.5 x 1760/2000 mm
Spindle:	9 mm (8 mm with spindle adapters)
Door gap:	2 - 5.5 mm
Settable functions:	Mechanical functions: <ul style="list-style-type: none"> - Handing of trigger bolt - Electrically controlled side (EL566, EL466) Electrical function: <ul style="list-style-type: none"> - Fail locked / Fail unlocked
Monitoring outputs:	Bolt deadlocked Trigger bolt in Handle used Cylinder used Cable sabotage

CONTROL PRINCIPLE AND AVAILABLE MONITORING OUTPUTS

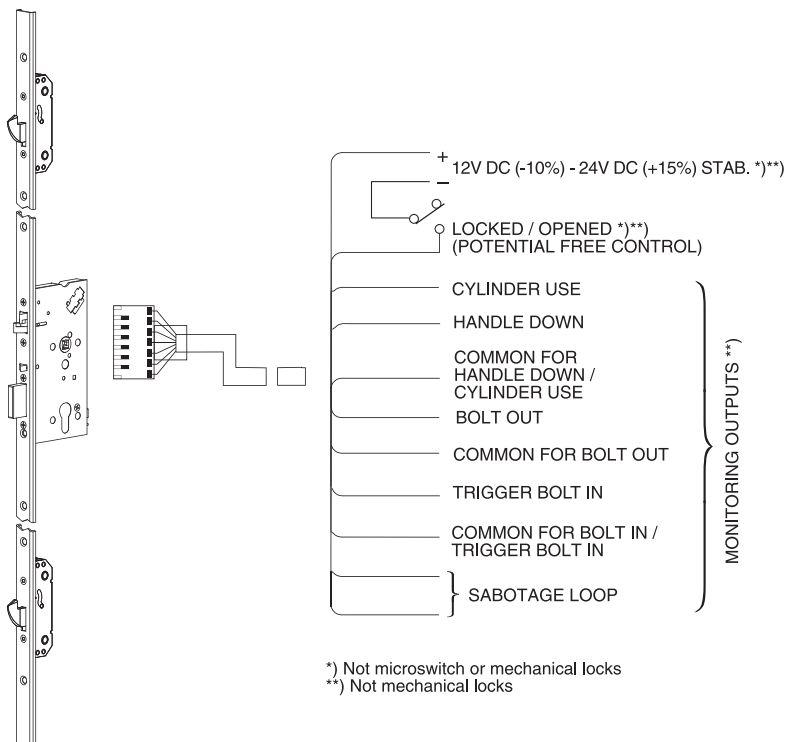

CYLINDERS, FITTINGS AND ACCESSORIES (please order separately)

	CYLINDERS ABLOY PROTEC ²	FITTINGS	CABLES	LEAD COVERS	STRIKER PLATES for main locks	STRIKER PLATES for auxiliary locks
Single	CY303T, CY313T CY321T, CY331T	ABLOY [®]) IKON Ruko BEZAULT others	EA218 (6m) EA219 (10m)	EA280 EA281	EA321**) EA322 EA323**) EA324 EA325 EA326 EA327 EA328 EA329 EA330 EA331 EA332**)	EA306 LP781
Double	CY304T, CY314T CY322T, CY332T					
Single with thumbturn	CY305T, CY315T CY323T, CY333T					

*) For further information, please contact Abloy Oy Architectural hardware.
**) Handing must be defined

DOOR ENVIRONMENT

Wooden and metal doors

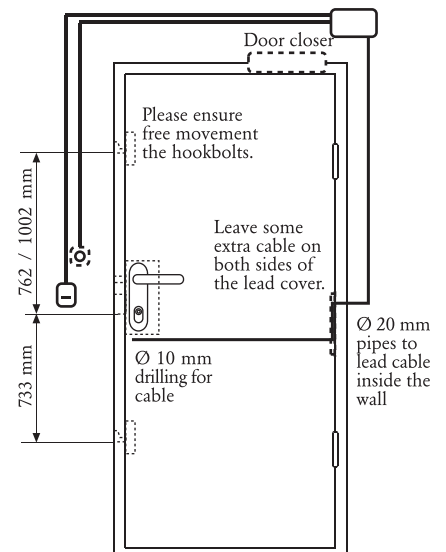

Narrow profile doors

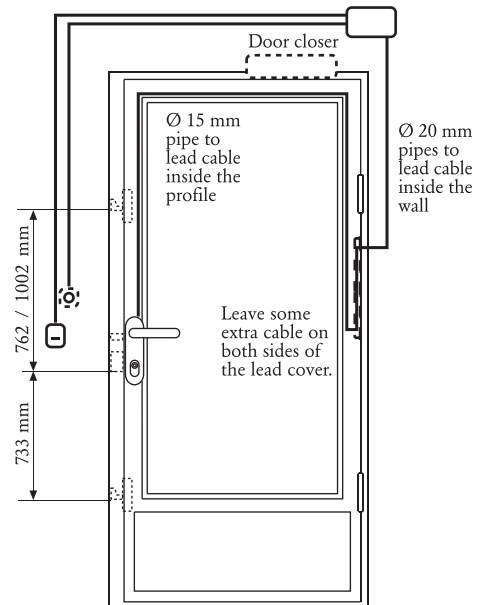

CAM ANGLE

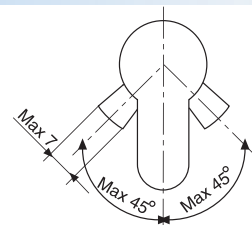

STRIKE PLATES

LP781

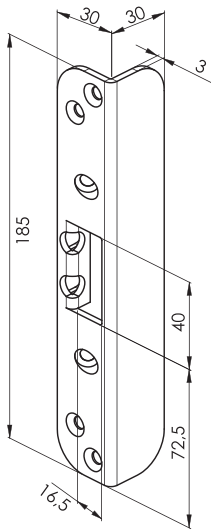

EA306

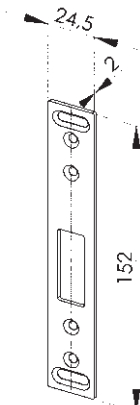

EA321**)

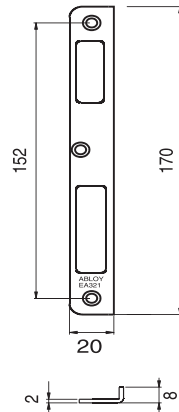

EA322

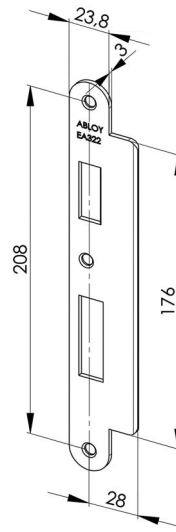

EA323**)

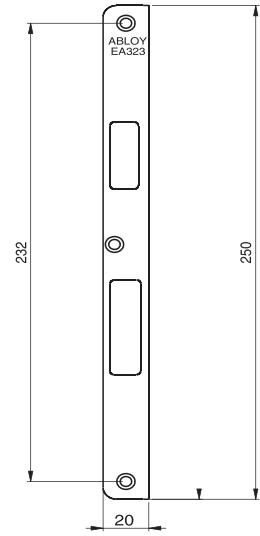

EA324

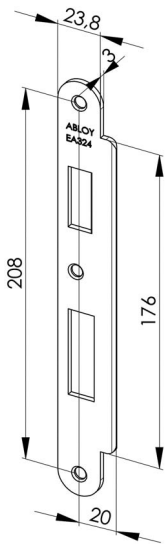

EA325

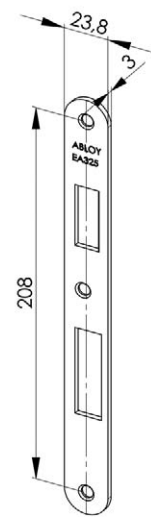

EA326

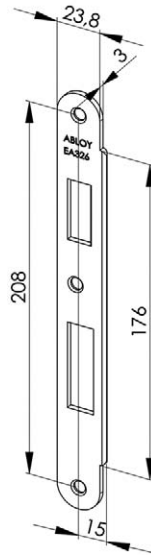

EA327

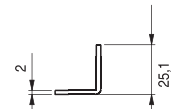
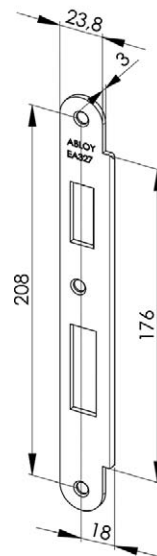

EA328

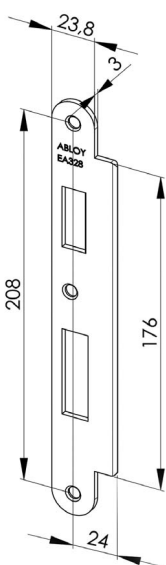

EA329

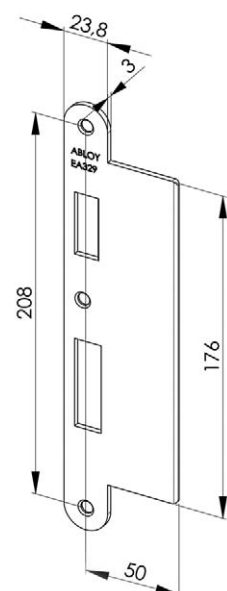

EA330

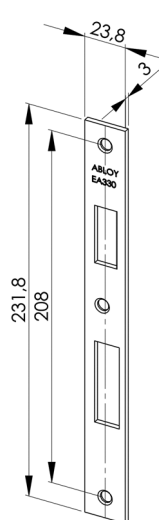

EA331

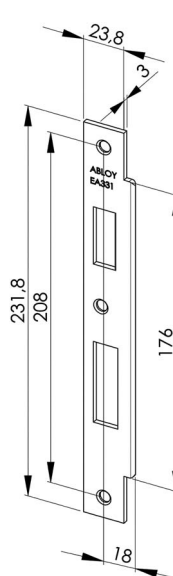

EA332**)

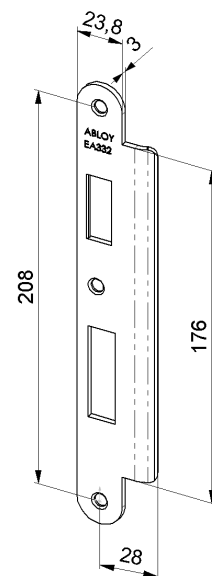

DIMENSIONS

EL466

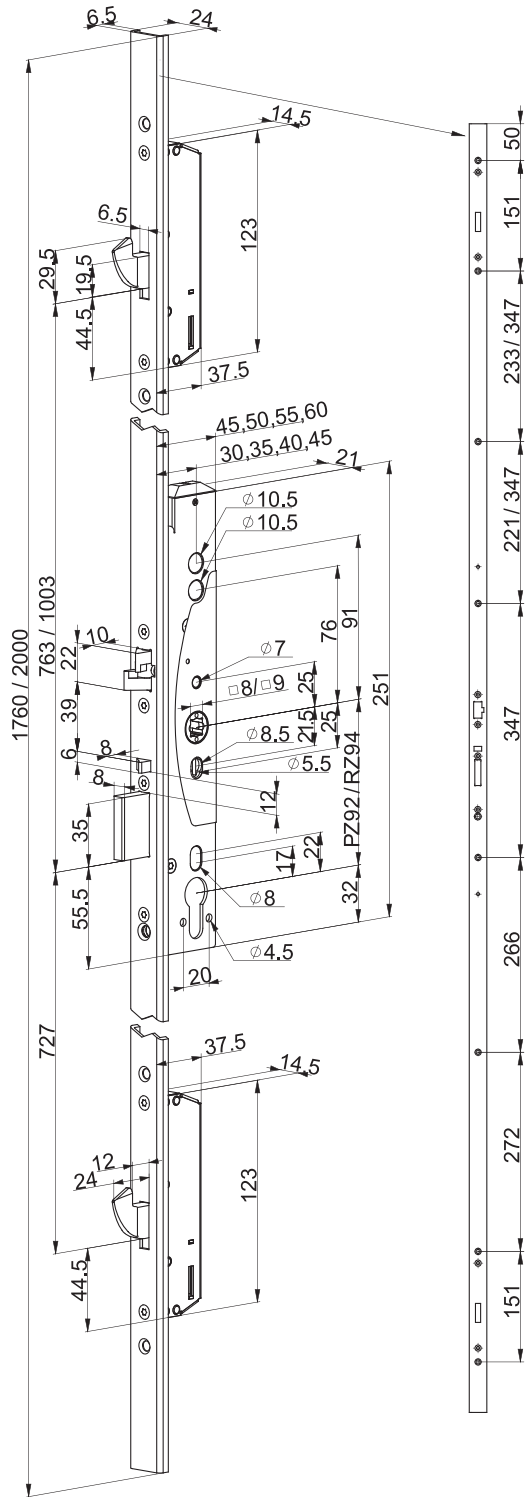

EL566

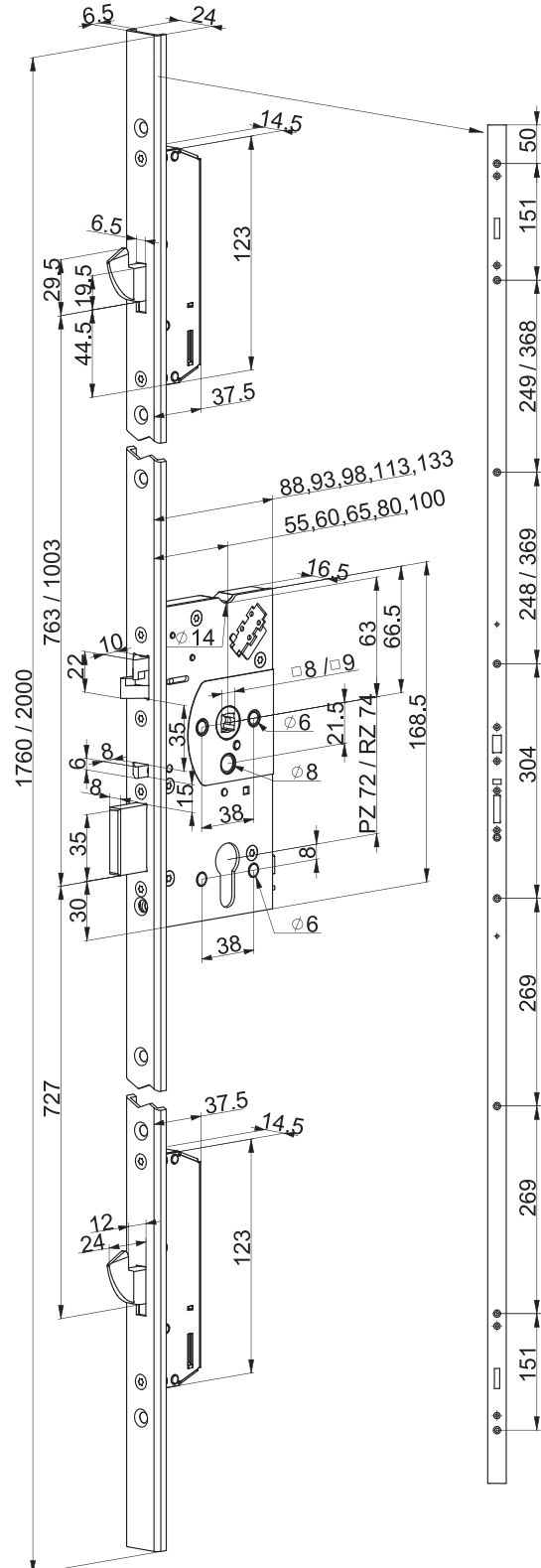

EMERGENCY EXIT DEVICES ACCORDING TO EN 179

The following locks and handles are approved to be installed together in an emergency exit door to conform EN 179.

Profile door locks	ABLOY® DO 20.33.01 DO 20.33.02	IKON DO 20.15.02	FSB DO 20.03.01, DO 20.03.02	HEWI DO 20.13.01, DO 20.13.02	SAPEX DO 20.32.01 DO 20.32.02
EL466	e.g. ABLOY® INOXI 3-19/013 PZ+PZ	e.g. S6B3, S6B6	10 1001 79, 06 1004 79 RTG/RTV, 10 1004 79, 06 1004 79 RTG/RTV, 10 1016 79, 06 1016 79 RTG/RTV, 10 1023 79, 06 1023 79 RTG/RTV, 10 1035 79, 06 1035 79 RTG/RTV, 10 1045 79, 06 1045 79 RTG/RTV, 10 1070 79, 06 1070 79 RTG/RTV, 10 1078 79, 06 1078 79 RTG/RTV, 10 1093 79, 06 1093 79 RTG/RTV, 10 1107 79, 06 1107 79 RTG/RTV, 10 1108 79, 06 1108 79 RTG/RTV, 10 1119 79, 06 1119 79 RTG/RTV, 10 1146 79, 06 1146 79 RTG/RTV, 10 1159 79, 06 1159 79 RTG/RTV, 10 1160 79, 06 1160 79 RTG/RTV, 10 1163 79, 06 1163 79 RTG/RTV, 10 1189 79, 06 1183 79 RTG, 10 1222 79, 06 1222 79 RTG/RTV	111, 111.23, 114.23GK, 131, 132, 111X, 113X, 114X, 161X, 163X, 171X, 112X, 165X, 166X	e.g. 60-00819
EL266 EL066	ABLOY® INOXI 3-19/013/120 PZ+BL	e.g. S6B8			
Wooden and metal door locks	ABLOY® DO 20.33.01 DO 20.33.02	IKON DO 20.15.02			SAPEX DO 20.32.01 DO 20.32.02
EL566	e.g. ABLOY® INOXI 3-19/012 PZ+PZ	e.g. S326, S426, S4K3			
EL366 EL166	ABLOY® INOXI 3-19/012/120 PZ+BL	e.g. S4K6			e.g. 60-0419, 60-0319

The safety features of this product are essential to its compliance with EN 179. No modification of any kind, other than those described in the installation manual, are permitted.

PANIC EXIT DEVICES INSTALLATION ACCORDING TO EN 1125

The following locks and push bars are approved to be installed together in a panic exit door to conform EN 1125. The push bars can be installed for example with above mentioned outside fittings (Table EN 179) to conform EN 1125.

Profile door locks	effeff DO 30.04	JPM DO 30.05	TESA DO 30.06
EL466 EL266 EL066	8000-00-1100 (-), 8000-10-1100 (PZ)		
EL468 EL268 EL068	8000-00-1100 (-), 8000-11-1100 (RZ)	NORMA 990000-XX-0A 990100-XX-0A 990001-XX-0A 990101-XX-0A 991000-XX-0A 991100-XX-0A 991001-XX-0A 991101-XX-0A	UNIVERSAL SERIE 19709G9xx
Wooden and metal door locks	effeff DO 30.04		
EL566 EL366 EL166	8000-00-1100 (-), 8000-20-1100 (PZ)		
EL568 EL368 EL168	8000-00-1100 (-), 8000-21-1100 (RZ)		

The safety features of this product are essential to its compliance with EN 1125. No modification of any kind, other than those described in the installation manual, are permitted.

EN179 and EN1125 standards are conformed, when the above mentioned lock is installed with **ABLOY®** striker plates listed in this brochure.

This document may not be used in the installation of a lock. Drilling and wiring diagrams and installation instructions are included in the installation manual, which is included in each lock case package.

We reserve the right to make alterations to the products described in this leaflet.



www.abloy.com

Abloy Oy
Wahlforssinkatu 20
P.O.Box 108
FI-80101 JOENSUU
FINLAND
Tel. +358 20 599 2501
Fax +358 20 599 2209

