

LOCK CASES

Assa offers a complete range of lock cases that meet all requirements for security, convenience and emergency exiting. The lock cases are constructed to meet high requirements set by authorities regarding forced entry and fire-rating.

Assa lock cases are available for all types of doors. They are available in different dimensions e.g. for narrow profile doors and for use with different types of electric strikes. The majority of Assa lock cases can be equipped with a micro switch for electric control of doors and access control solutions.

The product range includes patented hook bolt lock cases. The hook bolt interlocks door and frame and creates a strong unit.

The development, the evolution, can not be stopped. We must strive towards product development which meets the rising demands of security and user friendliness. Six different product series has been developed, which contents lock cases for almost every type of interior and exterior doors for offices, industries and residential doors.



Modular locks with round cylinder/thumb turn

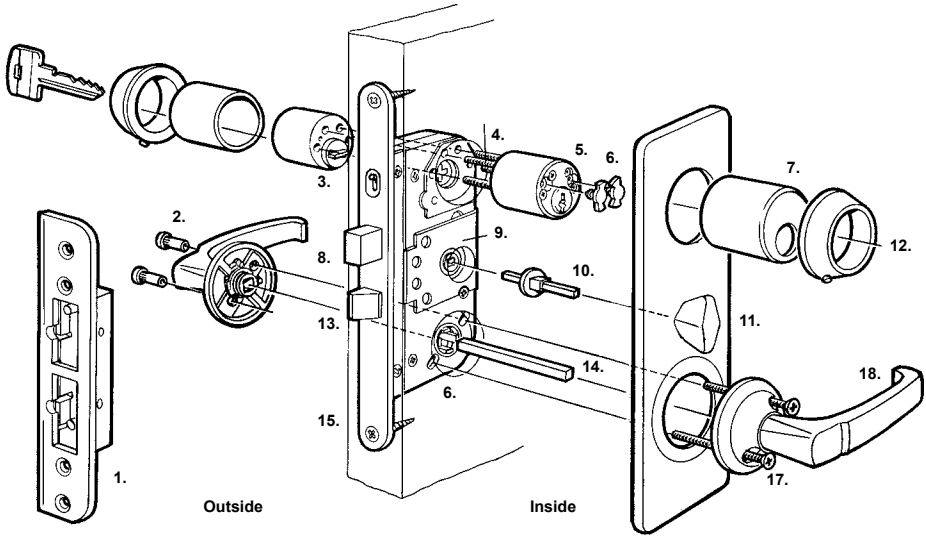

Round cylinder with thumb turn cylinder

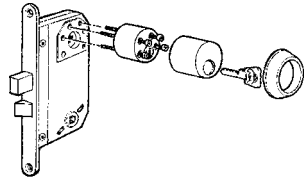

Modular locks with oval cylindershape duple cylinder (DC)

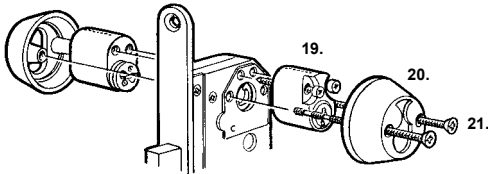

Oval single cylinder and thumb turn

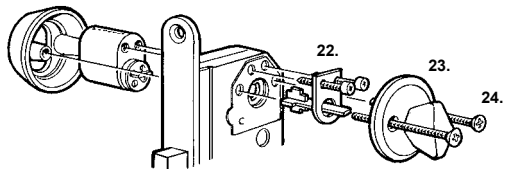



Narrow profile locks with SCD security accessories

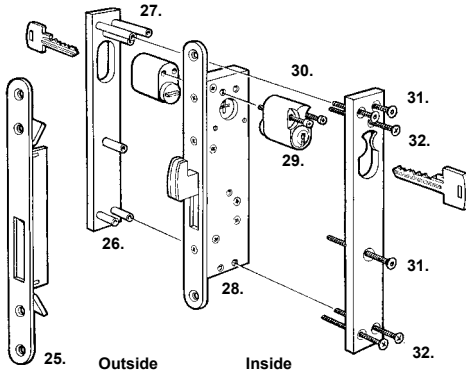

1. Security striking plates
2. Barrel nut
3. Extension piece
4. High resistance screw
5. Cylinder
6. Cylinder plug
7. Cylinder
8. Dead bolt
9. Manipulator protection
10. Thumb turn follower
11. Thumb turn plate
12. Cylinder ring
13. Lever handle latch bolt
14. Lever handle follower
15. Forend
16. Lock case
17. Lever handle screw
18. Lever handle

Narrow profile locks with standard accessories

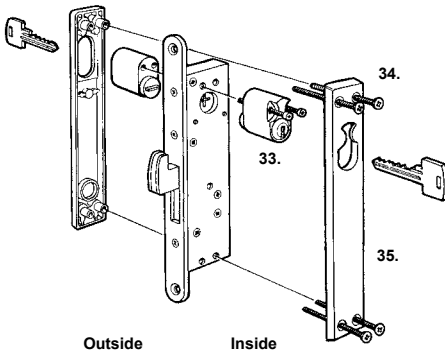

19. Cylinder
 20. Cylinder ring
 21. Cylinder screw
 22. Thumb turn tailpiece
 23. Thumb turn
 24. Thumb turn screw
-
25. Security striking plates
 26. Cylinder plate
 27. Nipple
 28. Lock case
 29. Cylinder
 30. Cylinder screw
 31. High resistance screw
 32. One way screw
-
33. Cylinder
 34. Plate screw
 35. Cylinder screw























Choose your lock accessories in accordance with existing demands on design, security and function. The following matrices display products related to frequently occurring mechanical lock units.

Products marked in red fulfil the requirements stated in EN 12209 security grade 5 to combine with *LS 12209.

* = Lock shield

Sash lock	Cylinder type	Cylinder accessories	Reinforcement accessories	Security striking plate	Lever handle
 8765	<p>Round double cylinder</p>   Round cylinder outside	 3212  3211	 4292	 1887  1887-5 1-4	 6616  6640

Sash lock	Night latch	Cylinder type	Cylinder accessories	Cover plate	Striking plate	Lever handle
 565	 560	<p>Oval double cylinder</p>   Oval cylinder outside	 18 256  256	 4291	 2864-1  2860-5	 1905  1949



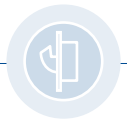

















Sash lock 2000	Cylinder type	Cylinder accessories	Reinforcement accessories/ Cover plate	Security striking plate	Lever handle
 2000	<p>Round double cylinder</p> 	 3212	<p>4292</p>  4292  4295	 1887 1-4  1887-5	 1918  1956  6638  6647



Choose your lock accessories in accordance with existing demands on design, security and function. The following matrices display products related to frequently occurring mechanical lock units.









Products marked in red fulfil the requirements stated in EN 12209 security grade 5 to combine with *LS 12209.









* = Lock shield

Dead lock	Cylinder type	Cylinder accessories	Reinforcement accessories	Security striking plate
 <p>8788</p>	<p>Round double cylinder</p> 	<p>3212</p> 	 <p>4290</p>	 <p>1888-1 1888-5</p>
	<p>Round cylinder outside</p> 	<p>3211</p> 		
Cylinder sash lock	Cylinder type	Cylinder accessories	Cover plate	Striking plate
	<p>Oval double cylinder</p> 	<p>18 256</p> 	 <p>4289</p>	 <p>2864-1</p>
	<p>Oval cylinder outside</p> 	<p>256</p> 		
Narrow profile lock hook bolt	Cylinder type	Security accessories	Security striking plate	
 <p>13 787</p>	<p>Oval double cylinder</p> 	<p>4559 4659 4759</p> 	<p>1887-9</p> 	
	<p>Oval cylinder outside</p> 			
	<p>Oval cylinder inside</p> 			
	<p>Oval thumb turn cylinder</p> 			



Choose your lock accessories in accordance with existing demands on design, security and function. The following matrices display products related to frequently occurring mechanical lock units.

Cylinder sash lock	Cylinder type	Cylinder accessories	Striking plate
 1385  13 585  1380	<p>Oval double cylinder</p> 	 44459  44859  44159	 2885

Double sash lock	Cylinder type	Cylinder accessories	Striking plate
 1362	<p>Oval double cylinder</p>  <p>Oval cylinder outside</p>  <p>Oval cylinder inside</p> 	 55459  55859  55159	 2864-1





Lever handle sash lock	Cylinder accessories	Striking plate
 1398	 55059	 2885





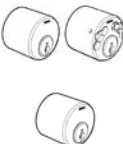







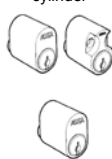

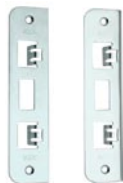
Choose your lock accessories in accordance with existing demands on design, security and function. The following matrices display products related to frequently occurring mechanical lock units.

Products marked in red fulfil the requirements stated in EN 12209 security grade 5 to combine with *LS 12209.

* = Lock shield

Sash lock	Cylinder type	Cylinder accessories	Reinforcement accessories	Security striking plate	Lever handle
 410-50	Round double cylinder  Round cylinder outside	 3212 3211	 4292	 1487 1487-5 1-4	 6616 6640

Sash lock	Night latch	Cylinder type	Cylinder accessories	Cover plate	Striking plate	Lever handle
 310-50	 220-50	Oval double cylinder  Oval cylinder outside	 18 256 256	 4291	 1264 1-4 1264 5-7	 1905 1949









Sash lock 2002	Cylinder type	Cylinder accessories	Reinforcement accessories / Cover plate	Security striking plate	Lever handle
 2002-50	Round double cylinder 	 3212	 4292 4295	 1487 1487-5 1-4	 1918 1956 6638 6647











Choose your lock accessories in accordance with existing demands on design, security and function. The following matrices display products related to frequently occurring mechanical lock units.

Products marked in red fulfill the requirements stated in EN 12209 security grade 5 to combine with *LS 12209.















* = Lock shield

Narrow profile lock two-step bolt	Cylinder type	Security accessories	Security striking plate
 <p>410-35</p>	<p>Oval double cylinder</p> 	 <p>5559E</p>	 <p>1487-9</p>
	<p>Oval cylinder outside</p> 	 <p>5659E</p>	
	<p>Oval cylinder inside</p> 	 <p>5759E</p>	
	<p>Oval thumb turn cylinder</p> 		

Narrow profile lock hook bolt	Cylinder type	Security accessories	Security striking plate
 <p>411-35</p>	<p>Oval double cylinder</p> 	 <p>4659E</p>	 <p>1487-9</p>
	<p>Oval cylinder outside</p> 	 <p>4559E</p>	
	<p>Oval cylinder inside</p> 	 <p>4759E</p>	
	<p>Oval thumb turn cylinder</p> 		



Choose your lock accessories in accordance with existing demands on design, security and function. The following matrices display products related to frequently occurring mechanical lock units.

Cylinder sash lock	Cylinder type	Cylinder accessories	Striking plate
 <p>230-35</p>	<p>Oval double cylinder</p>  <p>Oval cylinder outside</p>  <p>Oval cylinder inside</p> 	 <p>44459E</p> <p>44859E</p>	<p>1264</p> 
<p>Double sash lock</p>  <p>220-35</p>	<p>Oval double cylinder</p>  <p>Oval cylinder outside</p>  <p>Oval cylinder inside</p> 	 <p>55459</p> <p>55159</p>	<p>1264</p> 
<p>Lever handle sash lock</p>  <p>212-35</p>		 <p>55059</p>	<p>1264</p> 



The matrix below should be seen as a guideline when choosing which type of striking plate to choose.

The doorframe's construction, type and measurements must all be accounted for in order to guarantee a smooth and safe correlation between the lock case and the striking plate.

When a higher level of resistance to forced entry is desired a security striking plate is always recommended.

Lock case	Security Striking Plate		Striking Plate		
	1487-1, 5	1487-9	1264	1266	2887
212, 220, 221, 222, 230, 231, 232	■		●		
310	■		●		
311		■	●		●
313				●	
410, 411	●	●			
2002	●				
620, 621, 622, 624, 640	■		●		
710, 711	●	●			
721, 722, 727, 732	■		●		
761, 762, 767, 772	■		●		
810, 811	●	●			
880, 881, 884, 885	■		●		

- = Assa recommends
- = Alternative striking plate



The matrix below should be seen as a guideline when choosing which type of striking plate to choose.

The doorframe's construction, type and measurements must all be accounted for in order to guarantee a smooth and safe correlation between the lock case and the striking plate.

When a higher level of resistance to forced entry is desired a security striking plate is always recommended.

		Security Striking Plate				Striking Plate										
		1887-1-5	1887-9	1888	1824	2865	2860	2863	2862	2864	2866	2885	2888	2887	2876	2892
Modular Locks	560, 562, 564, 1560	●				●	●	●	●	●						
	5584, 5585, 6580					●	●	●	●	●		●				
	6585, 8561, 8562	●				●	●	●	●	●		●				
	1498, 6498					●	●	●	●	●		●				
	565, 2565	■				●	●	●	●	●						
	566										●					
	587	●														
	2587	●	■											●		
	2000, 8765, 8768	●														
	9788	●		■												
	7787	●														
9787	●	■														
Narrow Profile Locks	1362	●				●	●	●	●	●						
	1380, 1385, 13585, 1361	●				●	●	●	●	●		●				
	1398	●				●	●	●	●	●		●				
	13787	■	●													
Extra Locks	8788	■		●									■			
	585, 2580	■				●	●	●	●	●		●				
Cabinet Locks	576, 577														●	
	1592, 2592															●

- = Assa recommends
- = For use with dead latch striker 1893
- = Alternative striking plate



Application	Microswitch function	Lock case	Narrow profile	Extra
Alarm by-pass, Model M1.	Bi-stable function. Microswitch is depressed when bolt is in withdrawn position, changes when bolt leaves withdrawn position.	8765, 9788 7787, 9787		8788
Alarm by-pass and indication, Model M2.	Two microswitches. One has a bi-stable function and is depressed when bolt is in withdrawn position. Changes when bolt leaves withdrawn position. The other has a momentary function. Indicates use of exit. Is depressed and changes in operation. Returns when thumb turn is released.	8768		
Alarm by-pass and alarm circuit, Model M3.	Bi-stable function. Two microswitches. One is depressed at unthrown bolt. The other is pushed in at thrown and deadlocked bolt.	8765, 9788 7787, 9787		8788
Alarm circuit, Model M4.	Bi-stable function. Microswitch depressed at thrown bolt. Changes when bolt leaves extended position.		13787	
Alarm circuit, Model M5.	Bi-stable function. Microswitch depressed at thrown and deadlocked bolt. Indication of bolt thrown and deadlocked. Changes when deadlocking is released and bolt leaves extended position.	8765, 9788 7787, 9787 565		8788
Indication, Model M6.	Momentary function. Microswitch depressed and changed when opening with key or thumbturn.	560, 562, 564 1560, 5584 5585, 6580 6585		
Indication, Model M7.	Momentary function. Microswitch indicates movements of the emergency exit accessory. Microswitch depressed and changed when emergency exit accessory is used. Returns when thumb turn is released.	8768 8561, 8562	1361	
Indication, Model M8.	Momentary function. Microswitch indicates use of exit, key or thumb turn. Is depressed and changed in operation.	8561, 8562		
Indication, Model M9.	Momentary function. Microswitch indicates position of the cylinder latch. Is depressed and changed in operation.	560, 562, 564 1560, 5584 5585, 6585 8561, 8562		
Indication, Model M13.	Bi-stable function. Two microswitches. One is depressed at unthrown bolt. The second is depressed when thumb turn is disabled.	2000		



Microswitch functions		
MA		
Alarm circuit and Alarm by-pass		
Lock case	Two micro switches	
310, 311, 410, 411, 640	Sw 1 active when hook bolt is withdrawn. Sw 2 active when hook bolt is thrown and deadlocked.	Bi-stable Bi-stable
Alarm circuit and Alarm by-pass		
Lock case	Two micro switches	
2002	Sw 1 active when hook bolt is thrown and deadlocked. Sw 2 active when thumb turn is disabled by snib.	Bi-stable Bi-stable
MC		
Deadlocking and Cylinder/Turn and Handle		
Lock case	Three micro switches	
620, 621, 624	Sw 1 active when latch is deadlocked. Sw 2 active when cylinder, turn or handle* is used. Sw 3 active when handle* is used. * Only the insides handle on the split spindle variants.	Bi-stable Momentary Momentary
MD		
Lock-back		
Lock case	One micro switch	
220, 221, 223, 230, 231, 620, 621, 624	Activated by lock-back function.	Bi-stable
ME		
Alarm circuit and Escape function		
Lock case	Two micro switches	
710, 711, 727, 767	Sw 1 active when hook bolt is thrown and deadlocked. Sw 2 active when the handle of the emergency exit is used.	Bi-stable Momentary
MF		
Deadlocking and Cylinder/Turn		
Lock case	Two micro switches	
220, 221, 222, 223, 230, 231, 232	Sw 1 active when latch is deadlocked. Sw 2 active when cylinder or turn is used.	Bi-stable Momentary
MG		
Deadlocking and Cylinder/Turn and Escape function		
Lock case	Three micro switches	
721, 722, 732, 761, 762, 772	Sw 1 active when latch is deadlocked Sw 2 active when cylinder or turn is used. Sw 3 active when the handle of the emergency exit is used.	Bi-stable Momentary Momentary



Entrance and Perimeter Protection

Lock case for entrance, perimeter protection and other important doors.

Complies with EN 12209 security grade 5 to combine with *LS 12209

* = Lock shield

Lock case Application

Exterior function

Interior function

<p>Assa 2002-50 2002-70</p>	<p>Lock case for entrance doors in residential buildings; houses, apartments, apartment buildings for the elderly or disabled etc.</p>	<p>A 360° turn of key revokes the deadlock, places the hook bolt in thrown or withdrawn position and automatically re-engage thumb turn function. Lever handle retracts latch bolt.</p>		<p>A 95° turn of thumb turn revokes the deadlock and places the hook bolt in thrown or withdrawn position when enabled. The button in the face plate blocks and disables the thumb turn function. Lever handle retracts latch bolt.</p>
-------------------------------------	--	---	--	---

<p>Assa 410-50 410-70 410-35</p>	<p>Lock case for entrance doors, archive, store rooms, office premises, industries etc.</p>	<p>A 360° turn of key revokes the deadlock and places the hook bolt in thrown or withdrawn position.</p>	<p style="text-align: right;">410-50</p>	<p>A 360° turn of key revokes the deadlock and places the hook bolt in thrown or withdrawn position. Lever handle retracts latch bolt.</p>
--	---	--	--	--

<p>Assa 411-50 411-70 411-35</p>	<p>Lock case for entrance doors, sliding and swing doors equipped with a pull handle or a push plate.</p>	<p>A 360° turn of key revokes the deadlock and places the hook bolt in thrown or withdrawn position.</p>	<p style="text-align: right;">411-50</p>	<p>A 360° turn of key revokes the deadlock and places the hook bolt in thrown or withdrawn position.</p>
--	---	--	--	--

For Emergency escape lock, see page 85-95.



Entrance and Interior Doors

Lock case for entrance and interior doors where the requirements of burglary resistance are subordinate the function. Complies with EN 12209 security grade 3.

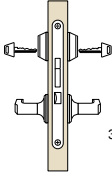
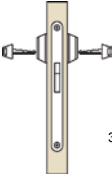
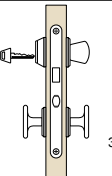
Lock case	Application	Exterior function		Interior function
Assa 310-50 310-70 310-35	Lock case for interior doors in offices, industries, toilette doors etc.	A 90° turn of key revokes the deadlock and places the hook bolt in thrown or withdrawn position. When hook bolt is in withdrawn position key operates latch bolt at 95°. Lever handle retracts latch bolt.		A 90° turn of key revokes the deadlock and places the hook bolt in thrown or withdrawn position. When hook bolt is in withdrawn position key operates latch bolt at 95°. Lever handle retracts latch bolt.
Assa 311-50 311-70 311-35	Lock case for sliding and swing doors equipped with a pull handle or a push plate.	A 90° turn of key revokes the deadlock and places the hook bolt in thrown or withdrawn position.		A 90° turn of key revokes the deadlock and places the hook bolt in thrown or withdrawn position.
Assa 313-50 313-70 313-35	Lock case for interior doors, push and swing doors, shops and entrance doors etc.	A 90° turn of key revokes the deadlock and places the hook bolt in thrown or withdrawn position. The door-knob is fixed.		A 90° turn of thumb turn revokes the deadlock and places the hook bolt in thrown or withdrawn position. The door-knob is fixed.

For Emergency escape lock, see page 85-95.



Entrance and Interior Doors

Lock case for entrance and interior doors where the requirements of burglary resistance are subordinate the function.

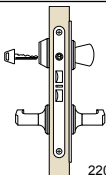
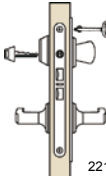
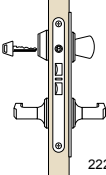
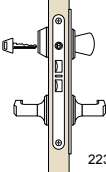
Lock case	Application	Exterior function		Interior function
Assa 220-50 220-70 220-35	Lock case for exterior and interior doors, entrance doors, technical areas etc.	A 90° turn of key revokes the deadlock and retracts the latch bolt. Lever handle retracts latch bolt.		A 90° turn of thumb turn revokes the deadlock and retracts the latch bolt. Lever handle retracts latch bolt. Cylinder latch is locked back with snib.
Assa 221-50 221-70 221-35	Lock case for exterior and interior doors, entrance doors, fire doors, technical areas etc.	A 90° turn of key revokes the deadlock and retracts the latch bolt. Lever handle retracts latch bolt.		A 90° turn of thumb turn revokes the deadlock and retracts the latch bolt. Lever handle retracts latch bolt. Cylinder latch is locked back with a token key.
Assa 222-50 222-70 222-35	Lock case for exterior and interior doors, entrance doors, fire doors, technical areas etc.	A 90° turn of key revokes the deadlock and retracts the latch bolt. Lever handle retracts latch bolt.		A 90° turn of thumb turn revokes the deadlock and retracts the latch bolt. Lever handle retracts latch bolt. Cylinder latch can not be locked back.
Assa 223-50 223-70 223-35	Lock case for exterior and interior doors, entrance doors, fire doors, technical areas etc.	A 90° turn of key revokes the deadlock and retracts the latch bolt. Lever handle retracts latch bolt.		A 90° turn of thumb turn revokes the deadlock and retracts the latch bolt. Lever handle retracts latch bolt. The cylinder latch is locked back with snib equipped with a locking nut. The snib can be secured in locked back or normal position.

For Emergency escape lock, see page 85-95.



Entrance and Interior Doors

Lock case for entrance and interior doors where the requirements of burglary resistance are subordinate the function.

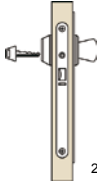
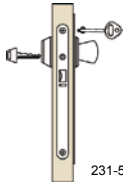
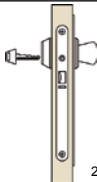
Lock case	Application	Exterior function		Interior function
Asa 230-50 230-70 230-35	Lock case for entrance doors and gates with pull handles, door closers or door automatics.	A 90° turn of key revokes the deadlock and retracts the latch bolt.		A 90° turn of thumb turn revokes the deadlock and retracts the latch bolt. Cylinder latch is locked back with snib.
Asa 231-50 231-70 231-35	Lock case for entrance doors and gates with pull handles, door closers or door automatics.	A 90° turn of key revokes the deadlock and retracts the latch bolt.		A 90° turn of thumb turn revokes the deadlock and retracts the latch bolt. Cylinder latch is locked back with a token key.
Asa 232-50 232-70 232-35	Lock case for entrance doors and gates with pull handles, door closers or door automatics.	A 90° turn of key revokes the deadlock and retracts the latch bolt.		A 90° turn of thumb turn revokes the deadlock and retracts the latch bolt.

For Emergency escape lock, see page 85-95.



Split Spindle

Lock case for entrance an interior doors with a split spindle function.

Lock case Application

Exterior function

Interior function

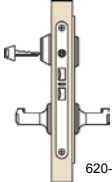
<p>Assa 620-50 620-70 620-35</p>	<p>Lock case for interior doors, class rooms, offices, technical areas etc. where quick and convenient exiting is important.</p>	<p>A 90° turn of key revokes the deadlock and retracts the latch bolt. Lever handle retracts latch bolt.</p>	 <p>620-50</p>	<p>Lever handle retracts both latch bolt and cylinder latch. Cylinder latch is locked back with snib.</p>
--	--	--	---	---

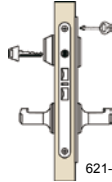
<p>Assa 621-50 621-70 621-35</p>	<p>Lock case for interior doors, class rooms, offices, technical areas etc. where quick and convenient exiting is important.</p>	<p>A 90° turn of key revokes the deadlock and retracts the latch bolt. Lever handle retracts latch bolt.</p>	 <p>621-50</p>	<p>Lever handle retracts both latch bolt and cylinder latch. Cylinder latch is locked back with a token key.</p>
--	--	--	---	--

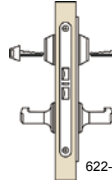
<p>Assa 622-50 622-70 622-35</p>	<p>Lock case for interior doors, class rooms, offices, technical areas etc. where quick and convenient exiting is important.</p>	<p>A 90° turn of key revokes the deadlock and retracts the latch bolt. Lever handle retracts latch bolt.</p>	 <p>622-50</p>	<p>Lever handle retracts both latch bolt and cylinder latch. Cylinder latch can not be locked back.</p>
--	--	--	---	---

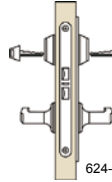
<p>Assa 624-50 624-70 624-35</p>	<p>Lock case for interior doors, class rooms, offices, technical areas etc. where quick and convenient exiting is important.</p>	<p>A 90° turn of key revokes the deadlock and retracts the latch bolt. Lever handle retracts latch bolt.</p>	 <p>624-50</p>	<p>Lever handle retracts both latch bolt and cylinder latch. Cylinder latch is locked back with inside thumb turn.</p>
--	--	--	---	--

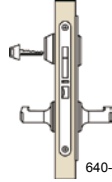
<p>Assa 640-50 640-70 640-35</p>	<p>Lock case for interior doors, class rooms, offices, technical areas, hotel rooms etc. with higher requirements of burglary resistance and where quick and convenient exiting is important.</p>	<p>A 90° turn of key revokes the deadlock and retracts hook bolt and latch bolt. Lever handle retracts latch bolt.</p>	 <p>640-50</p>	<p>Lever handle retracts both hook bolt and latch bolt.</p>
--	---	--	---	---

For Emergency escape lock, see page 85-95.



Entrance and Perimeter Protection

Lock case for entrance, perimeter protection and other important doors.
Complies with EN 12209 security grade 5 with LS 12209 security grade 5.

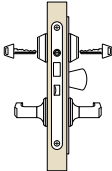
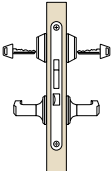
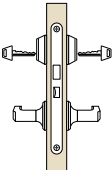
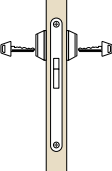
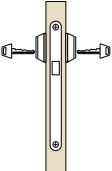
Lock case	Application	Exterior function		Interior function
Assa 2000-50	Lock case for entrance doors in residential buildings; houses, apartments, apartment buildings for the elderly or disabled etc.	A 360° turn of key revokes the deadlock, places the bolt in thrown or withdrawn position and automatically re-engage thumb turn function. Lever handle retracts latch bolt.		A 95° turn of thumb turn revokes the deadlock and places the bolt in thrown or withdrawn position when enabled. The button in the face plate blocks and disables the thumb turn function. Lever handle retracts latch bolt. Key operation as per cylinder side.
Assa 7787-50	Lock cases for entrance doors, archive, store rooms, office premises, industries etc.	A 360° turn of key revokes the deadlock and places the hook bolt in thrown or withdrawn position. Lever handle retracts latch bolt.		A 360° turn of key revokes the deadlock and places the hook bolt in thrown or withdrawn position. Lever handle retracts latch bolt.
Assa 8765-50 8765-70	Lock cases for entrance doors, archive, store rooms, office premises, industries etc.	A 360° turn of key revokes the deadlock and places the bolt in thrown or withdrawn position.		A 360° turn of key revokes the deadlock and places the bolt in thrown or withdrawn position.
Assa 9787-50	Lock case for entrance doors, sliding and swing doors equipped with a pull handle or a push plate.	A 360° turn of key revokes the deadlock and places the hook bolt in thrown or withdrawn position.		A 360° turn of key revokes the deadlock and places the hook bolt in thrown or withdrawn position.
Assa 9788-50 9788-70	Lock case for entrance doors, sliding and swing doors equipped with a pull handle or a push plate.	A 360° turn of key revokes the deadlock and places the bolt in thrown or withdrawn position.		A 360° turn of key revokes the deadlock and places the bolt in thrown or withdrawn position.



Entrance and Interior Doors

Lock case for entrance and interior doors where the requirements of burglary resistance are subordinate the function. Complies with EN 12209 security grade 3.

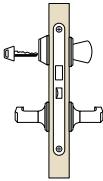
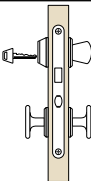
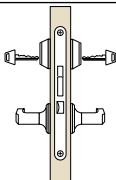
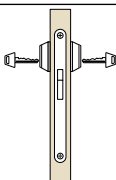
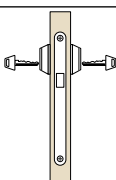
Lock case	Application	Exterior function		Interior function
Assa 565-50 565-70	Lock case for interior doors in offices, industries, toilette doors etc.	A 90° turn of key revokes the deadlock and places the bolt in thrown or withdrawn position. When bolt is in withdrawn position key operates latch bolt at 95°. Lever handle retracts latch bolt.		A 90° turn of thumb turn revokes the deadlock and places the bolt in thrown or withdrawn position. When bolt is in withdrawn position thumb turn operates latch bolt at 95°. Lever handle retracts latch bolt.
Assa 566-50 566-70	Lock case for interior doors, push and swing doors, shops and entrance doors etc.	A 95° turn of key revokes the deadlock and places the bolt in thrown or withdrawn position. The door-knob is fixed.		A 95° turn of thumb turn revokes the deadlock and places the bolt in thrown or withdrawn position. The door-knob is fixed.
Assa 587-50	Lock case for interior doors in industries, shop etc.	An 85° turn of key revokes the deadlock and places the hook bolt in thrown or withdrawn position. Lever handle retracts latch bolt.		An 85° turn of key revokes the deadlock and places the hook bolt in thrown or withdrawn position. Lever handle retracts latch bolt.
Assa 2587-50	Lock case for entrance doors, sliding and swing doors equipped with a pull handle or a push plate.	An 85° turn of key revokes the deadlock and places the hook bolt in thrown or withdrawn position.		An 85° turn of key revokes the deadlock and places the hook bolt in thrown or withdrawn position.
Assa 2588-50 2588-70	Lock case for entrance doors and swing doors equipped with a pull handle or a push plate.	A 90° turn of key revokes the deadlock and places the bolt in thrown or withdrawn position.		A 90° turn of key revokes the deadlock and places the bolt in thrown or withdrawn position.



Entrance and Interior Doors

Lock case for entrance and interior doors where the requirements of burglary resistance are subordinate the function.

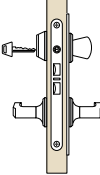
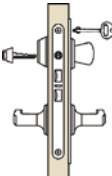
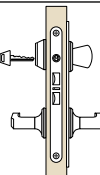
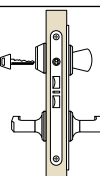
Lock case	Application	Exterior function		Interior function
Assa 560-50 560-70	Lock case for exterior and interior doors, entrance doors to technical areas etc.	A 75° turn of key revokes the deadlock and retracts the latch bolt. Lever handle retracts latch bolt.		A 75° turn of thumb turn revokes the deadlock and retracts the latch bolt. Lever handle retracts latch bolt. Cylinder latch is locked back with snib.
Assa 562-50 562-70	Lock case for exterior and interior doors, entrance doors to technical areas etc.	A 75° turn of key revokes the deadlock and retracts the latch bolt. Lever handle retracts latch bolt.		A 75° turn of thumb turn revokes the deadlock and retracts the latch bolt. Lever handle retracts latch bolt. Cylinder latch is locked back with a token key.
Assa 564-50	Lock case for exterior and interior doors, entrance doors to technical areas etc.	A 75° turn of key revokes the deadlock and retracts the latch bolt. Lever handle retracts latch bolt.		A 75° turn of thumb turn revokes the deadlock and retracts the latch bolt. Lever handle retracts latch bolt. The cylinder latch is locked back with snib equipped with a locking nut. The snib can be secured in locked back or normal position.
Assa 1560-50 1560-70	Lock case for exterior and interior doors, entrance doors to technical areas etc.	A 75° turn of key revokes the deadlock and retracts the latch bolts. Lever handle retracts latch bolt.		A 75° turn of thumb turn revokes the deadlock and retracts the latch bolt. Lever handle retracts latch bolt. Cylinder latch can not be locked back.



Entrance and Interior Doors

Lock case for entrance and interior doors where the requirements of burglary resistance are subordinate the function.

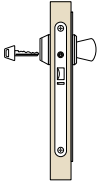
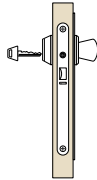
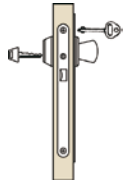
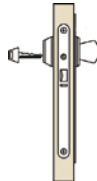
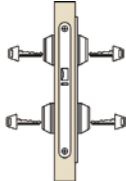
Lock case	Application	Exterior function		Interior function
Assa 5584-50 5584-70	Lock case for entrance doors with pull handles, door closers or door automatics.	A 75° turn of key revokes the deadlock and retracts the latch bolt.		A 75° turn of thumb turn revokes the deadlock and retracts the latch bolt. Cylinder latch is locked back with snib.
Assa 5585-50 5585-70	Lock case for entrance doors and gates with pull handles, door closers or door automatics.	A 75° turn of key revokes the deadlock and retracts the latch bolt.		A 75° turn of thumb turn revokes the deadlock and retracts the latch bolt. Cylinder latch is locked back with a token key.
Assa 6580-50 6580-70	Lock case for interior doors with pull handles, door closers or door automatics.	A 75° turn of key retracts the latch bolt.		A 75° turn of thumb turn retracts the latch bolt. Cylinder latch is locked back with a token key.
Assa 6585-50 6585-70	Lock case for entrance doors and gates with pull handles, door closers or door automatics.	A 75° turn of key revokes the deadlock and retracts the latch bolt.		A 75° turn of thumb turn revokes the deadlock and retracts the latch bolt.
Assa 5761-50	Lock case where two separate lock systems are able to open the same lock independent of each other.	Cylinder latch retracts with a key through one of the two external cylinders.		Cylinder latch retracts with a key through one of the two external cylinders alternatively, if wanted, a lever handle.



Split Spindle

Lock case for entrance an interior doors with a split spindle function.

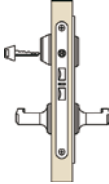
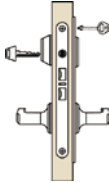
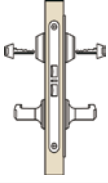
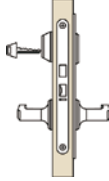
Lock case	Application	Exterior function		Interior function
Assa 504-50 504-70	Lock case for interior doors, class rooms, offices, technical areas etc. where quick and convenient exiting is important.	A 90° turn of key revokes the deadlock and retracts the latch bolt. Lever handle retracts atch bolt.		Lever handle retracts both latch bolt and cylinder latch. Cylinder latch is locked back with snib.
Assa 506-50 506-70	Lock case for interior doors, class rooms, offices, technical areas etc. where quick and convenient exiting is important.	A 90° turn of key revokes the deadlock and retracts the latch bolt. Lever handle retracts latch bolt.		Lever handle retracts both latch bolt and cylinder latch. Cylinder latch is locked back with a token key.
Assa 509-50 509-70	Lock case for interior doors, class rooms, offices, technical areas etc. where quick and convenient exiting is important.	A 90° turn of key revokes the deadlock and retracts the latch bolt. Lever handle retracts latch bolt.		Lever handle retracts both latch bolt and cylinder latch. Cylinder latch is locked back with inside thumb turn.
Assa 1520-50 1520-70	Lock case for interior doors, class rooms, offices, technical areas, hotel rooms etc. with higher requirements of burglary resistance and where quick and convenient exiting is important.	A 90° turn of key revokes the deadlock and retracts bolt and latch bolt. Lever handle retracts latch bolt.		Lever handle retracts both bolt and latch bolt.



Narrow Profile Lock

Lock case for entrance, perimeter protection and other important doors with narrow profile construction. Complies with EN 12209 security grade 5 to combine with *LS 12209.

* = Lock shield

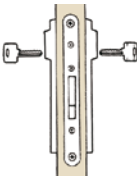
Lock case	Application	Exterior function		Interior function
Assa 13787	Lock case for entrance doors in shops, department stores, offices etc.	A 360° turn of key revokes the deadlock, places the hook bolt in thrown or withdrawn position.		A 360° turn of key revokes the deadlock, places the hook bolt in thrown or withdrawn position.



Narrow Profile Lock

Lock case for interior and entrance doors with narrow profile construction.

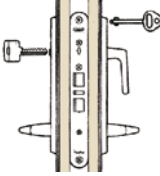
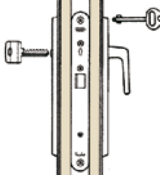
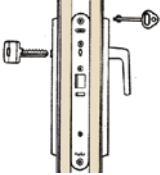
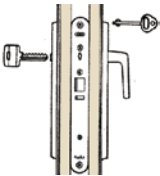
Lock case	Application	Exterior function		Interior function
Assa 1362	Lock case for entrance doors and gates in shops, apartment blocks etc.	A 90° turn of key revokes the deadlock and retracts latch bolt. Lever handle retracts latch bolt.		A 90° turn of thumb turn revokes the deadlock and retracts the latch bolt. Lever handle retracts latch bolt. Cylinder latch is locked back with a token key.
Assa 1380	Lock case for interior doors with pull handles, door closers or door automatics in shops, department stores, offices, apartment blocks etc.	A 90° turn of key retracts the latch bolt.		A 90° turn of thumb turn retracts the latch bolt. Lever handle retracts latch bolt. Cylinder latch is locked back with a token key.
Assa 1385	Lock case for entrance doors and gates with pull handles, door closers or door automatics in shops, department stores, offices, apartment blocks etc.	A 90° turn of key revokes the deadlock and retracts the latch bolt.		A 90° turn of thumb turn revokes the deadlock and retracts the latch bolt. Cylinder latch is locked back with a token key.
Assa 13585	Lock case for entrance doors and gates with pull handles, door closers or door automatics in shops, department stores, offices, apartment blocks etc.	A 90° turn of key revokes the deadlock and retracts the latch bolt.		A 90° turn of thumb turn revokes the deadlock and retracts the latch bolt. Cylinder latch can not be locked back.



evolution® by Assa

Evolution

Evolution is the latest ASSA lock case series. The Evolution series will successively replace both modular and narrow profile lock cases and incorporates a number of new functions. Evolution is available with backset 35, 50 and 70 mm.

All Evolution lock cases with lever handle latch and/or no lockable cylinder latch are approved for installation in doors made of timber, aluminium and steel in fire grading E/EI 15 - E/E160. (Tg.nr. 0456/01).

Latch Hook Bolt Lock 2002

Application

Lock case for entrance doors within residential segment; houses, apartments, apartment buildings for the elderly and disabled etc.

Features

- Available with backset 70 mm or 50 mm
- Meets the requirements of the EN 12209 security grade 5, combine with *LS 12209
* = Lock shield
- With lever latch and hook bolt
- Lock back device for thumb turn in the forend
- Guided hook bolt of hardened steel
- The hook bolt interlocks door and frame
- Reinforced deadlocking
- Handing of lever latch is reversible
- Steel lever latch for fire-rated doors
- Available with a built-in micro switch

Function

- The hook bolt is operated with key or thumb turn
- When the snib is pressed down, the thumb turn function is blocked so that the lock cannot be opened without key = away secure
- When the lock is opened with key, the thumb turn function is automatically activated = home convenient
- The lever latch is retracted with handle





Latch Hook Bolt Lock 410

Application

Lock case for entrance doors, file rooms, storage areas, offices, industrial buildings etc.

Features

Available with backset 70, 50 or 35 mm

- Meets the requirements of the EN 12209 security grade 5, combine with *LS 12209
* = Lock shield
- With lever latch and hook bolt
- Guided hook bolt of hardened steel
- Reinforced deadlocking
- The hook bolt interlocks door and frame
- Handing of lever latch is reversible
- Steel lever latch for fire-rated doors
- Available with a built-in micro switch

Function

- The hook bolt is operated with key or thumb turn
- The lever latch is retracted with handle



Hook Bolt Lock 411

Application

Lock case for entrance doors, sliding and swing doors equipped with a pull handle or a push plate.

Features

- Available with backset 70, 50 or 35 mm
- Meets the requirements of the EN 12209 security grade 5, combine with *LS 12209
* = Lock shield
- Guided hook bolt of hardened steel
- Reinforced deadlocking
- The hook bolt interlocks door and frame
- Available with a built-in micro switch

Function

- The hook bolt is operated with key or thumb turn





Latch Hook Bolt Lock 310

Application

Lock case for interior doors in industrial buildings, shops etc.

Features

- Available with backset 70, 50 or 35 mm
- Meets the requirements of the EN 12209 security grade 3
- With hook bolt and lever latch
- Handing of the lever latch is reversible
- Lever latch of steel for fire-rated doors
- The hook bolt interlocks door and frame

Function

- The hook bolt is operated with key or thumbturn
- The lever latch is retracted with lever handle



Hook Bolt Lock 311

Application

Lock case for interior doors in industrial buildings and shops, in sliding doors, swing doors etc.

Features

- Available with backset 70, 50 or 35 mm
- Meets the requirements of the EN 12209 security grade 3
- With hook bolt
- The hook bolt interlocks door and frame

Function

- The hook bolt is operated with key or thumbturn



Hook Bolt Lock 313

Application

Lock case for interior doors, sliding and swing doors, shops and entrance doors etc.

Features

- Available with backset 70, 50 or 35 mm
- Meets the requirements of the EN 12209 security grade 3
- With hook bolt and adjustable roller latch
- The hook bolt interlocks door and frame
- Combined with pull handle or push plate

Function

- The hook bolt is operated with key or thumb turn
- The roller latch is depressed by the striking plate



Double Latch Locks 220, 221, 222, 223

Application

Lock cases for exterior and interior doors, entrance doors, technical areas etc.

Features

- Available with backset 70, 50 and 35 mm
- With cylinder, deadlocking and lever latch
- The cylinder latch deadlocks automatically when it is extracted 14 mm and the deadlocking latch is depressed
- Available with a built-in micro switch
- The cylinder latch can be locked back
- Handing of the latches is reversible
- Steel lever latch for fire-rated doors
- Can be combined with electric strikes

Function

- Cylinder, deadlocking and lever latch are retracted with key or thumbturn
- The lever latch is retracted with lever handle

The lock-back mechanism in the face plate has the following functions:

- 220 Cylinder latch is locked back with snib
- 221 Cylinder latch is locked back with a token key
- 222 Cylinder latch cannot be locked back
- 223 Cylinder latch is locked back with snib equipped with a locking nut.
The snib can be secured in locked back or normal position





230-50



231-50



232-50

Cylinder Latch Locks 230, 231, 232

Application

Lock cases for entrance doors and gates with pull handles, door closers or door automatics.

Features

- Available with backset 70, 50 or 35 mm
- With cylinder and deadlocking latch
- Automatic deadlocking of cylinder latch at 14 mm extraction and depressed deadlocking latch
- Available with a built-in micro switch
- The cylinder latch can be locked back
- Handing of the cylinder latch is reversible
- Can be combined with electric strikes

Function

- Cylinder and deadlocking latch are retracted with key or thumbturn

The lock-back mechanism in the face plate has the following functions:

- 230 Cylinder latch is locked back with snib
- 231 Cylinder latch is locked back with a token key
- 232 Cylinder latch cannot be locked back



Latch Lock 212

Application

Lock case for doors where only lever function is desired.

Features

- Available with backset 70, 50 or 35 mm
- With lever latch
- Handing of the lever latch is reversible
- Steel lever latch for fire-rated doors

Function

Lever latch is retracted with lever handle



Latch Hook Bolt Lock 640 with Split Spindle Function

Application

Lock case for class rooms, hotels, technical areas, offices etc. where high demand of security, quick and convenient exit is important.

Features

- Available with backset 70, 50 or 35 mm
- Meets the requirements of the EN 12209 security grade 3
- With deadlocking lever latch and hook bolt
- Automatic deadlocking of cylinder latch at 14 mm extraction and depressed deadlocking latch
- Handing of the lever latch is reversible
- Can be mounted with or without outside handle

Function

- Outside
 - The deadbolt is operated with key
 - The lever latch is retracted with handle
- Inside
 - The deadbolt is operated with thumb turn
 - Lever latch and deadbolt are retracted with lever latch





620-50



621-50



622-50
624-50

Double Latch Locks 620, 621, 622, 624 with Split Spindle Function

Application

Lock case for interior doors, class rooms, offices, and technical areas etc. where quick and convenient exiting is important.

Features

- Available with backset 70, 50 or 35 mm
- With cylinder, deadlocking and lever latch
- Automatic deadlocking of cylinder latch at 14 mm extraction and depressed deadlocking latch
- Available with a built-in micro switch
- The cylinder latch can be locked in
- Handing of the latches is reversible
- Lever latch of steel for fire-rated doors
- Can be combined with electric strikes

Function

- Outside
 - Cylinder, deadlocking and lever latch are retracted with key
 - Lever latch is retracted with handle
- Inside
 - Cylinder, deadlocking and lever latch are retracted with handle

The lock-back mechanism in the face plate has the following functions:

- 620 Cylinder latch is locked back with snib
- 621 Cylinder latch is locked back with a token key
- 622 Cylinder latch cannot be locked back
- 624 Cylinder latch is locked back with inside handle



All Modular lock cases with lever handle latch and/or no lockable cylinder latch are approved for installation in doors made of timber, aluminium and steel in fire grading E/EI 15 - E/E160. (Tg. nr. 1039 99)

Latch Deadbolt Lock 2000

Application

Lock case for entrance doors within residential segment; houses, apartments, apartment buildings for the elderly and disabled etc.

Features

- Available with backset 50 mm
- Meets the requirements of the EN 12209 security grade 5, combine with *LS 12209
* = Lock shield
- With lever latch and deadbolt
- Blocking mechanism (snib) for thumb turn function in the face plate
- Guided deadbolt of hardened steel
- Handing of the lever latch is reversible
- Lever latch of steel for fire-rated doors
- Available with a built-in micro switch

Function

- The bolt is operated with key or thumb turn
- When the snib is pressed down, the thumb turn function is blocked so that the lock cannot be opened without key = away secure
- When the lock is opened with key, the thumb turn function is automatically activated = home convenient
- The lever latch is retracted with handle



Latch Hook Bolt Lock 7787

Application

Lock case for entrance doors, file rooms, storage areas, offices, industrial buildings etc.

Features

- Available with backset 50 mm
- Meets the requirements of the EN 12209 security grade 5, combine with *LS 12209
* = Lock shield
- With lever latch and hook bolt
- Guided hook bolt of hardened steel
- The hook bolt interlocks door and frame
- Handing of the lever latch is reversible
- Lever latch of steel for fire-rated doors
- Available with a built-in micro switch

Function

- The hook bolt is operated with key or thumb turn
- The lever latch is retracted with handle





Latch Deadbolt Lock 8765

Application

Lock case for entrance doors, file rooms, storage areas, offices, industrial buildings etc.

Features

- Available with backset 50 and 70 mm
- Meets the requirements of the EN 12209 security grade 5, combine with *LS 12209
* = Lock shield
- With lever latch and deadbolt
- Guided deadbolt of hardened steel
- Handing of the lever latch is reversible
- Lever latch of steel for fire-rated doors
- Available with a built-in micro switch

Function

- The deadbolt is operated with key or thumb turn
- The lever latch is retracted with handle



Hook Bolt Lock 9787

Application

Lock case for entrance doors, sliding and swing doors with a pull handle or a push plate.

Features

- Available with backset 50 mm
- Meets the requirements of the EN 12209 security grade 5, combine with *LS 12209
* = Lock shield
- Guided hook bolt of hardened steel
- The hook bolt interlocks door and frame
- Available with a built-in micro switch

Function

The hook bolt is operated with key or thumb turn



Deadbolt Locks 9788

Application

Lock case for entrance doors, sliding and swing doors with a pull handle or a push plate.

Features

- Available with backset 50 and 70 mm
- Meets the requirements of the EN 12209 security grade 5, combine with *LS 12209
* = Lock shield
- Guided deadbolt of hardened steel
- Available with a built-in micro switch

Function

The deadbolt is operated with key or thumb turn



Latch Deadbolt Lock 565

Application

Lock case for exterior and interior doors, offices, industrial buildings etc.

Features

- Available with backset 50 and 70 mm
- Meets the requirements of the EN 12209 security grade 3
- With lever latch and deadbolt
- Handing of the lever latch is reversible
- The lock can be complemented with toilet accessories

Function

- The deadbolt is operated with key or thumb turn
- The lever latch is retracted with handle, key or thumb turn





Roller Latch Lock with Deadbolt 566

Application

Lock case for interior doors, sliding and swing doors, shop and entrance doors.

Features

- Available with backset 50 and 70 mm
- Meets the requirements of the EN 12209 security grade 3
- With deadbolt and adjustable roller latch
- Combined with pull handle or push plate

Function

- The deadbolt is operated with key or thumb turn
- The roller latch is depressed by the striking plate



Hook Bolt Lock 587

Application

Lock case for interior doors in industrial buildings, shops etc.

Features

- Available with backset 50 mm
- Meets the requirements of the EN 12209 security grade 3
- With hook bolt and lever latch
- The hook bolt deadlocks automatically at 85° extraction
- Handing of the lever latch is reversible
- Lever latch of steel for fire-rated doors
- The hook bolt interlocks door and frame

Function

- The hook bolt is operated with key or thumb turn
- The lever latch is retracted with handle



Hook Bolt Lock 2587

Application

Lock case for interior doors in industrial buildings, shops, sliding doors, swing doors etc.

Features

- Available with backset 50 mm
- Meets the requirements of the EN 12209 security grade 3
- With hook bolt
- The hook bolt interlocks door and frame

Function

The hook bolt is operated with key or thumb turn



3-point Locks 2565, 6498

Application

Lock case for fire doors on boats and oil rigs.

Features

- Available with backset 50 and 70 mm
- With lever latch (6498)
- With deadbolt (2565)
- Handing of the lever latch with 16 mm extraction is reversible
- Lever latch of steel for fire-rated doors
- The locks can be connected with a linkage rod

Function

- The deadbolt is operated with key or thumb turn
- The lever latch is retracted with handle
- If the locks are connected according to the figure, all three locks will be operated through the 2565.

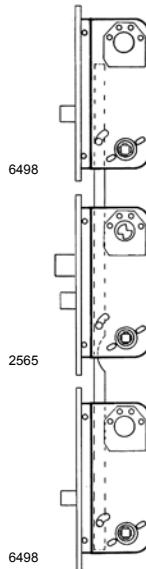



Deadbolt Lock 2588

Application

Lock case for entrance doors, sliding and swing doors with a pull handle or a push plate.

Features

- Meets the requirements of the EN 12209 security grade 3
- With deadbolt

Function

The deadbolt is operated with key or thumb turn



Double Latch Locks 560, 562, 564, 1560

Application

Lock case for exterior and interior doors, entrance doors, technical areas etc.

Features

- Available with backset 50 and 70 mm
- With cylinder, deadlocking and lever latch
- Automatic deadlocking of cylinder latch at 14 mm extraction and depressed deadlocking latch
- Available with a built-in micro switch
- The cylinder latch can be locked back
- Handing of the latches is reversible
- Lever latch of steel for fire-rated doors
- Can be combined with electric strikes

Function

- Cylinder, deadlocking and lever latch are retracted with key or thumb turn
- Lever latch is retracted with handle

The lock-back mechanism in the face plate has the following functions:

- 560 Cylinder latch is locked back with snib
- 562 Cylinder latch is locked back with a token key
- 564 Cylinder latch is locked back with snib equipped with a locking nut. The snib can be secured in locked back or normal position
- 1560 Cylinder latch cannot be locked back



560



562



564



1560



5584

Cylinder Latch Locks 5584, 5585, 6580, 6585

Application

Lock case for entrance doors and gates with pull handles, door closers or door automatics.

Features

- Available with backset 50 and 70 mm
- With cylinder and deadlocking latch
- Automatic deadlocking of cylinder latch at 14 mm extraction and depressed deadlocking latch
- Available with a built-in micro switch
- The cylinder latch can be locked back
- Handing of the latches is reversible
- Can be combined with electric strikes

Function

Cylinder and deadlocking latch are retracted with key or thumb turn

The lock-back mechanism in the face plate has the following functions:

- 5584 Cylinder latch is locked back with snib
- 5585 Cylinder latch is locked back with a token key
- 6580 Without deadlocking function, cylinder latch is locked back with a token key
- 6585 Cylinder latch cannot be locked back



5585



6580



6585



Latch Bolt Locks 1498

Application

Lock case for doors where only lever handle function is desired.

Features

- Available with backset 50 and 70 mm
- With lever latch
- Handing of the lever latch is reversible
- Lever latch of steel for fire-rated doors

Function

Lever latch is retracted with handle



Latch Deadbolt Lock 1520 with Split Spindle Function

Application

Lock case for classrooms, hotel rooms, technical areas, offices etc. with high demands against forced entry and where quick and convenient exiting is required.

Features

- Available with backset 50 and 70 mm
- Meets the requirements of the EN 12209 security grade 3
- With deadlocking lever latch and bolt
- The lever latch deadlocks automatically when it is extracted 14 mm and the deadlocking latch is depressed
- Handing of the lever latch is reversible
- Can be mounted with or without outside handle

Function

- Outside
 - The deadbolt is operated with key
 - The lever latch is retracted with handle
- Inside
 - The deadbolt is operated with thumb turn
 - Lever latch and deadbolt are retracted with lever handle





Double Latch Locks 504, 506, 509 with Split Spindle Function

Application

Lock case for interior doors, offices, technical areas, etc. with high demands against forced entry and where quick and convenient exiting is required.

Features

- Available with backset 50 and 70 mm
- With cylinder, deadlocking and lever latch
- The cylinder latch deadlocks automatically when it is extracted 14 mm and the deadlocking latch is depressed
- The cylinder latch can be locked back
- Handing of the latches is reversible
- Lever latch of steel for fire-rated doors
- Can be combined with electric strikes

Function

- Outside
 - Cylinder, deadlocking and lever latch are retracted with key
 - Lever latch is retracted with handle
- Inside
 - Cylinder, deadlocking and lever latch are retracted with lever handle

Cylinder, deadlocking and lever latch are retracted with lever handle

- 504 Cylinder latch is locked back with snib
- 506 Cylinder latch is locked back with a token key
- 509 Cylinder latch is locked back with inside thumb turn





Double Cylinder Lock 5761

Application

Lock case for entrance, basement and storage area doors with a pull handle or a push plate.

Features

- Available with backset 50 mm
- With cylinder and deadlocking latch
- Automatic deadlocking of cylinder latch at 14 mm extraction and depressed deadlocking latch
- The cylinder latch can be locked back
- Handing of the latches is reversible
- Cylinder latch of steel for fire-rated doors
- Complemented with Assa accessory set 5761-1 or 5761-3
- Can be combined with electric strikes

Function

- Outside
 - Cylinder latch is retracted with key using one of the two cylinders
- Inside
 - Cylinder latch is retracted with key using one of the cylinders (5761-3) or with handle (5761-1)





All narrow profile lock cases with lever handle latch and/or no lockable cylinder latch are approved for installation in doors made of timber, aluminium and steel in fire grading E/EI 15 - E/E160. (Tg. nr. 1039 99)



Hook Bolt Lock 13 787

Application

Lock case for entrance doors in shops, department stores, offices etc. with narrow profile construction.

The lock is ideal for use in patio and balcony doors without an espagnolette.

Features

- Available with backset 28 mm
- Meets the requirements of the EN 12209 security grade 3
- Guided hook bolt of hardened steel
- The hook bolt interlocks door and frame
- Available with a built-in micro switch

Function

Hook bolt is operated with key or thumb turn



Double Latch Locks 1362

Application

Lock case for entrance doors in shops, offices, apartment buildings etc. with narrow profile door construction.

Features

- Available with backset 28 mm
- With cylinder, deadlocking and lever latch
- The cylinder latch deadlocks automatically when it is extracted 14 mm and the deadlocking latch is depressed
- The cylinder latch can be locked back
- Can be combined with electric strikes

Function

- Cylinder and lever latch are retracted with key or thumb turn
- Lever latch is retracted with handle
- Cylinder latch can be locked back with a token key



Cylinder Latch Locks 1380, 1385, 13 585

Application

Lock case for entrance doors in shops, department stores, offices, apartment buildings etc. with narrow profile door construction and with a pull handle and a door closer or door automatics.

Features

- Available with backset 28 mm
- With cylinder and deadlocking latch
- The cylinder latch deadlocks automatically when it is extracted 14 mm and the deadlocking latch is depressed
- The cylinder latch can be locked back
- Can be combined with electric strikes

Function

Cylinder latch is retracted with key or thumb turn

- 1380 Without deadlocking function. Cylinder latch is locked back with a token key
- 1385 Cylinder latch can be locked back with a token key.
- 13585 Cylinder latch cannot be locked back





Latch Bolt Locks 1398

Application

Lock case for interior doors and corridor doors with narrow profile construction and when only handle function is desired.

Features

- Available with backset 28 mm
- With lever latch

Function

Lever latch is retracted with handle



Auxiliary Lock 8788

Application

Lock case for use as a complementary lock in entrance doors, gates and swing doors.

Features

- Backset 50 mm
- Meets the requirements of the EN 12209 security grade 3
- Guided deadbolt of hardened steel
- Available with a built-in micro switch
- Mortise lock that requires other door preparation than modular locks

Function

The bolt is operated with key or thumb turn



Cylinder Latch Locks 585, 2580

Application

Lock case for entrance doors and gates for retro-fitting/aftermarket where modular locks cannot be installed.

Features

- Backset 50 mm
- With cylinder and deadlocking latch
- The cylinder latch can be locked back
- Can be combined with electric strikes
- Mortise lock that requires other door preparation than modular locks
 - 585 the cylinder latch deadlocks automatically when it is extracted 14 mm and the deadlocking latch is depressed
 - 2580 without deadlocking function

Function

- Cylinder latch is retracted with key or thumb turn
- Cylinder latch is locked back with a token key





Latch Lock 576

Application

Lock case for surface mounting in doors with construction that does not allow mounting of modular locks.

Features

- With cylinder and deadlocking latch
- Reversible cylinder latch
- The cylinder latch deadlocks automatically when it is extracted 14 mm and the deadlocking latch is depressed
- The cylinder latch can be locked back

Function

- Cylinder latch is retracted with key or thumb turn
- The cylinder latch is locked back by depressing it in the lock case and is released with thumb turn or key



Deadbolt Lock 577

Application

Lock case for surface mounting in doors with construction that does not allow mounting of modular locks.

Features

- With deadbolt
- * The deadbolt is reinforced with hardened steel pins for increased protection against cutting

Function

The bolt is operated with key or thumb turn



593, 1593, 2593, 3593

Application

Lock for cabinet doors, electric cabinets etc.

Features

- Cabinet locks for construction cylinders
- Dead bolt equipped with an adjusting screw
- Dead bolt turn 90°
- Can be completed with an extension ring to suit other door thicknesses

Function

- The lock is operated with key
- The key can only be removed in locked position

Lock type	Door thickness	Extension ring, mm
593	20 - 65	
1593	0 - 45	
2593	37 - 80	
3593	0 - 7	37
3593	7 - 12	30
3593	12 - 17	25
3593	17 - 22	20
3593	22 - 27	15
3593	27 - 32	10
3593	32 - 37	5



593



1593



3593 2593

1592, 2592

Application

Locks for cabinet doors, hatches etc.

Features

- For construction cylinders
- Can be complemented with an extension ring to suit other door thicknesses

Function

- Dead bolt or latch is operated with key
- The key can be removed both in locked and unlocked position

- 1592 With latch
- 2592 With dead bolt

Lock type	Door thickness	Extension ring, mm
1592	20 - 60	
2592	20 - 60	
1592	10 - 20	10
2592	10 - 20	
1592	0 - 10	20
2592	0 - 10	



1592



2592



530



1530

Blocking Locks 530, 1530

Application

Lock for blocking electric main switches and fuse boxes. Prevents unauthorised persons from switching on the power and subsequently causing accidents.

Features

- Shackles of bright zinc steel
- For construction cylinders

Function

- The shackle is operated with key
- 530 Single secured
- 1530 Multiple secured; up to six persons can block the lock with another blocking lock or a padlock



Medicine Cabinet Lock 1596

Application

Lock for medicine cabinets, refrigerators etc.

Features

- For construction cylinders
- With latch and deadlocking latch
- Complemented with an extension ring when the door thickness is less than 22 mm
- The cylinder latch deadlocks automatically when it is extracted 10 mm and the deadlocking latch is depressed

Function

- The latch is retracted with key
- The key can be removed in locked position only



Security Striking Plates 1487-1 – 1487-5, 1487-9

Application

For perimeter protection and other important doors, where security is of essence.

Features

- Meets the requirements of the EN 12209 security grade 3
- Mounted with high security screws to resist higher break force and for maximum resistance to attack.

Function

- For protection of the lock case dead bolt from physical attack and manipulation.
- With edge rolled front for low friction between striking plate and the latch.
Ex. 1487-1 – 1487-4 have adjustable lips in the security box to get the right border pressure.



	Width	Lip	Angle	Length
1487-1	40	13,5		200
1487-2	40	16,5		200
1487-3	43,5	20		200
1487-4	45	21,5		200
1487-5	29,5	5,5	29,5	200
1487-9	25	5,5		245

Standard Striking Plates 1264-1 – 1264-8

Application

For interior doors and accommodation where standard locking is required.

Features

- For limited break force
- Rounded leading edge for low friction between the striking plate and latch bolt

Function

- Keep the door in closed position through the latch bolt/dead bolt engagement
- 1264-1 – 1264-7 with single adjusting lip for adjustment of border pressure



	Width	Lip	Angle	Length
1264-1	36	13,5		150
1264-2	36	16		150
1264-3	36	19		150
1264-4	40	23		150
1264-5	36	13		150
1264-6	36	16		150
1264-7	40	20		150
1264-8	24	5,5	22	155



1887-1

1887-5

1888-1



1888-5

1887-9

1887-1 – 1887-5, 1887-9, 1824-1 –1824-7, 1888-1, 1888-5

Application

For perimeter protection and other important doors, where security is of essence.

Features

- Meets the requirements of the EN 12209 security grade 3
- Mounted with high security screws to resist higher break force and for maximum resistance to attack.

Function

- With edge rolled front for low friction between striking plate and the latch
Ex. 1887-1 – 1887-4 have adjustable lips in the security box to get the right border pressure
- Plane security striking plates 1887-1 1887-5 for modular locks has adjustable screws to eliminate elasticity in the frame.
- Plane security striking plates 1887-1 1887-4 can be complemented with tin plate 1895 for alternative lip width.
- 1887-1 – 1887-4 can be complemented with deadlocking bar 1893 for locks with deadlocking latch.

	Width	Lip	Angle	Length
1824-1	32	5,5	8	225
1824-2	32	5,5	25	225
1824-3	32	7,5	27	225
1824-4	32	7,5	15	225
1824-5	40	14	8	225
1824-6	32	5,5	15	225
1824-7	32	5,5	20	225
1887-1	40	12,5		200
1887-2	40	15,5		200
1887-3	43,5	19		200
1887-4	45	20,5		200
1887-5	29,5	4,5	29,5	200
1888-1	30	7		150
1888-5	29	6	27	150
1887-9	25	5.5		245



2800, 2860, 2861, 2862, 2863, 2864, 2865, 2866, 2876, 2885, 2887, 2888, 2892

Application

For interior doors and accomodation where standard locking is required.

Features

- For limited break force
- Rounded leading edge for low friction between the striking plate and latch bolt

Function

- Keep the door in a closed position through the latch/dead bolt engagement
- 2864, 2865, 2860 and 2861 with single adjusting lip for adjustment of border pressure



2860-1



2861



2862-2



2863-5



2864



2865-1



2885



2887-1



2888

	Width	Lip	Angle	Length	Ri/Le
2860-1	35	15,5	-	155	X
2860-2	41,5	22	-	155	X
2860-5	24	3,5	22	155	X
2861	40	21	-	135	
2862-1	35	15	-	125	
2862-2	35	21,5	-	125	
2862-3	32,5	14,5	-	213	
2862-6					
2863-5	22	4	8	215	
2863-6	22	4	22	215	
2864-1	35	15	-	125	
2864-2	32,5	12,5	-	125	
2865-1	40	12,5	-	200	
2865-2	40	15,5	-	200	
2885	36	17,5	-	83	
2887-1	25	-	-	125	
2887-2	40	-	-	132	
2888	22	-	-	83	



2866-1



2866-2

2866-1, 2866-2, 2876-1, 2876-5, 2892-5, 2892-6

Application

For interior doors and accomodation that don't require approved locking.

Features

- For limited break force
- Rounded leading edge for low friction between the striking plate and latch bolt

Function

Keep the door in a closed position with latch or dead bolt operation



2876-1 *



2876-5 *

	Width	Lip	Angle	Length	Ri/Le
2866-1	33	14,5	-	127	X
2866-2	43	14,5	-	127	
2876-1 *	60	9	-	70	
2876-5 *	27,5	6	8	111	
2892-5	20	2	12,5	50	
2892-6	17		6	50	



2892-5



2892-6

* = For rim lock 576 and 577

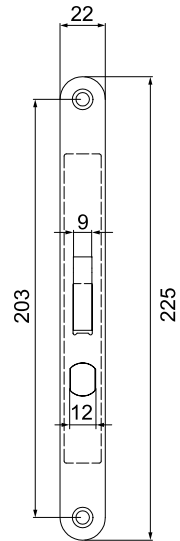
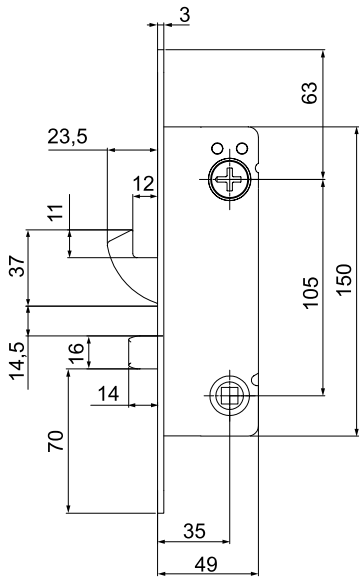
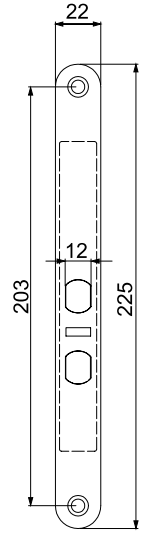
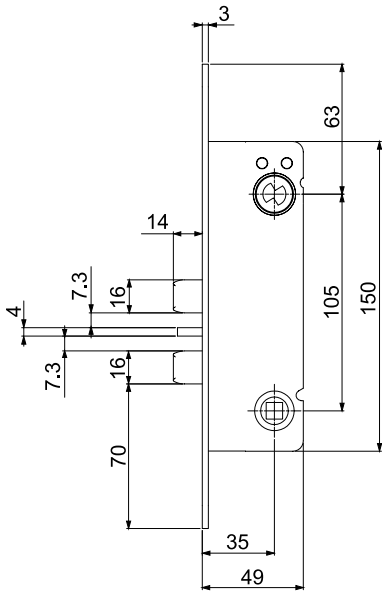

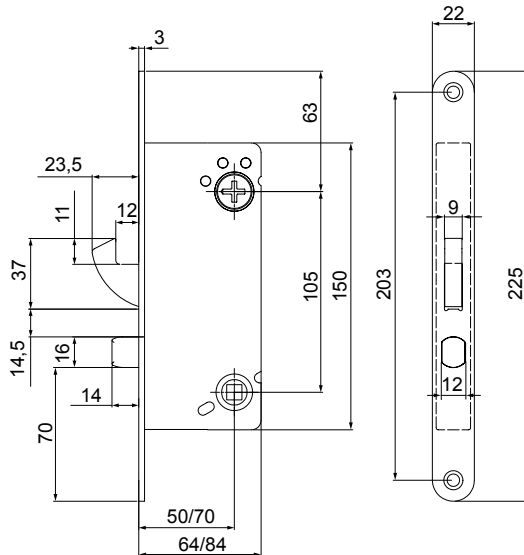
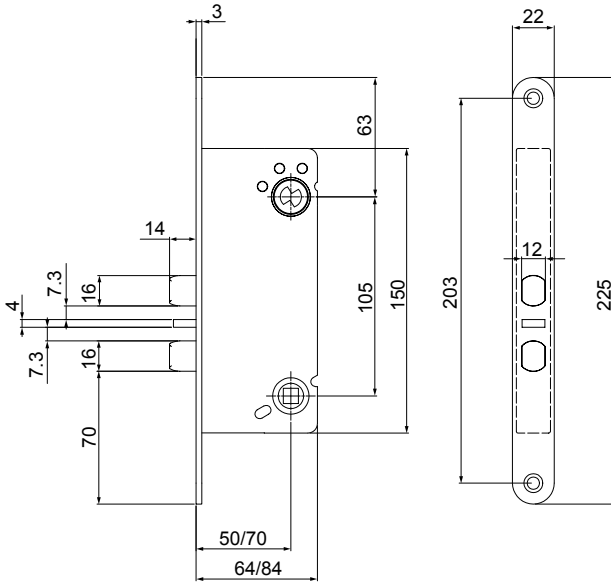

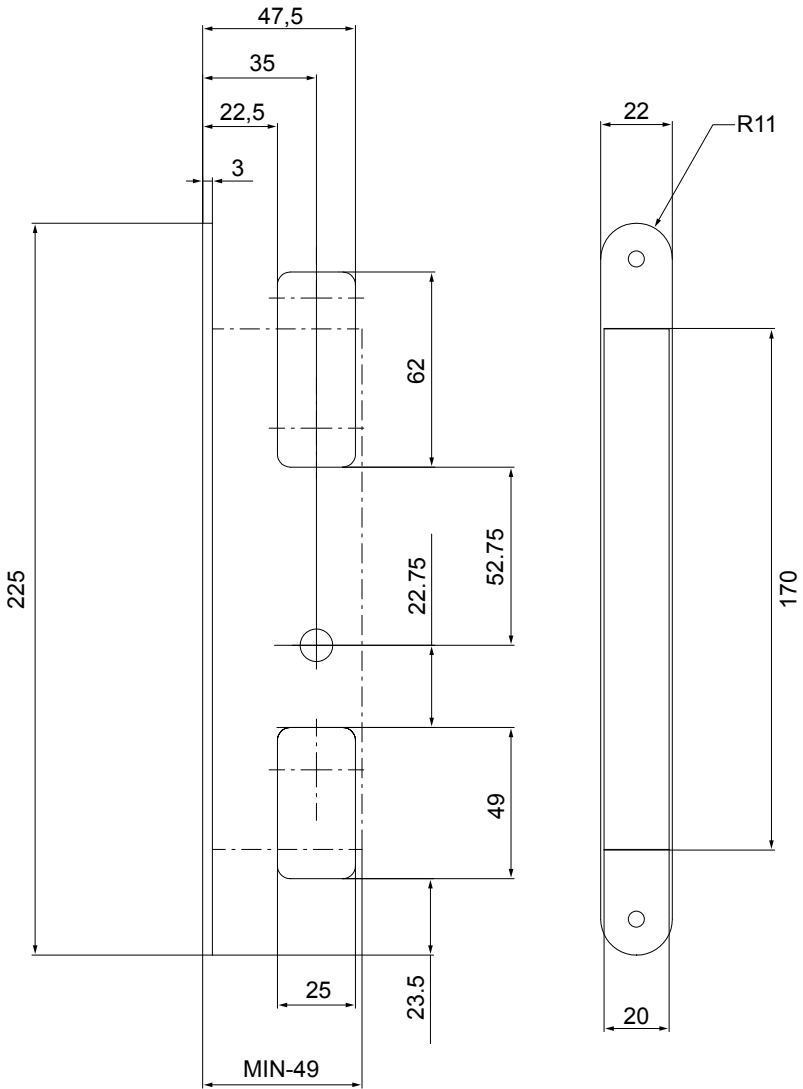

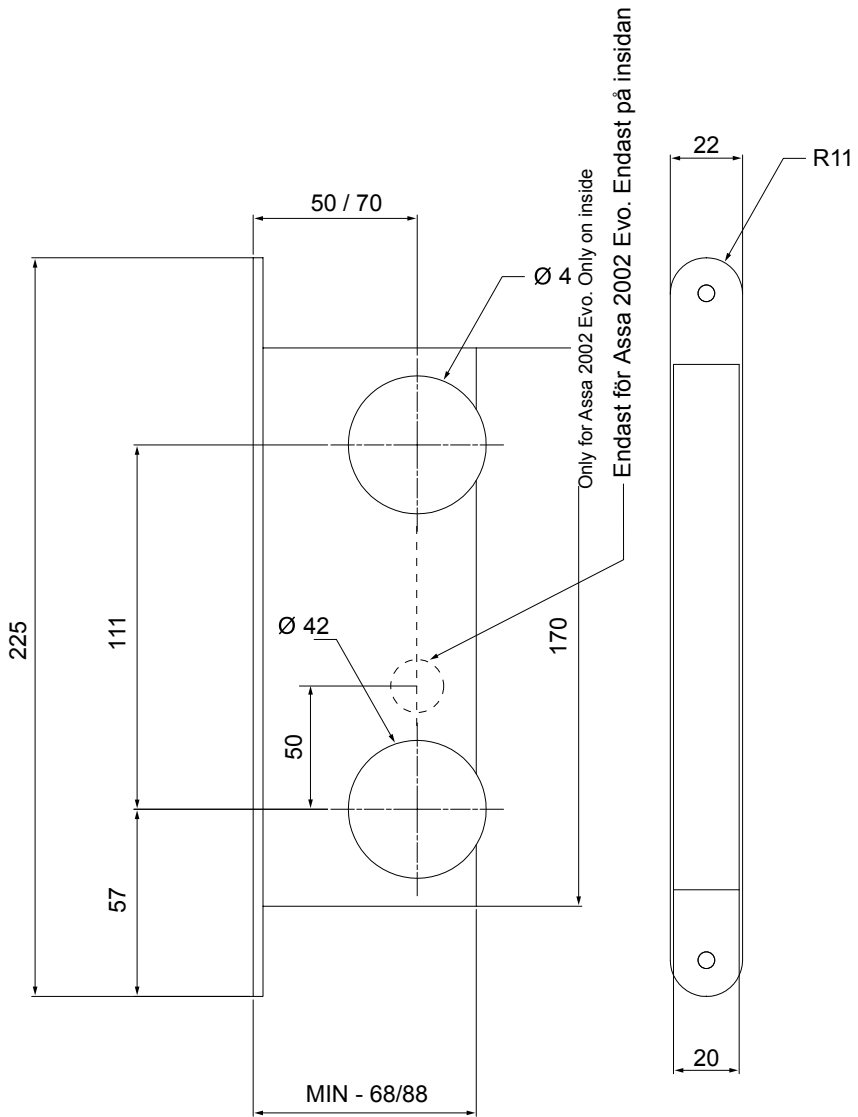

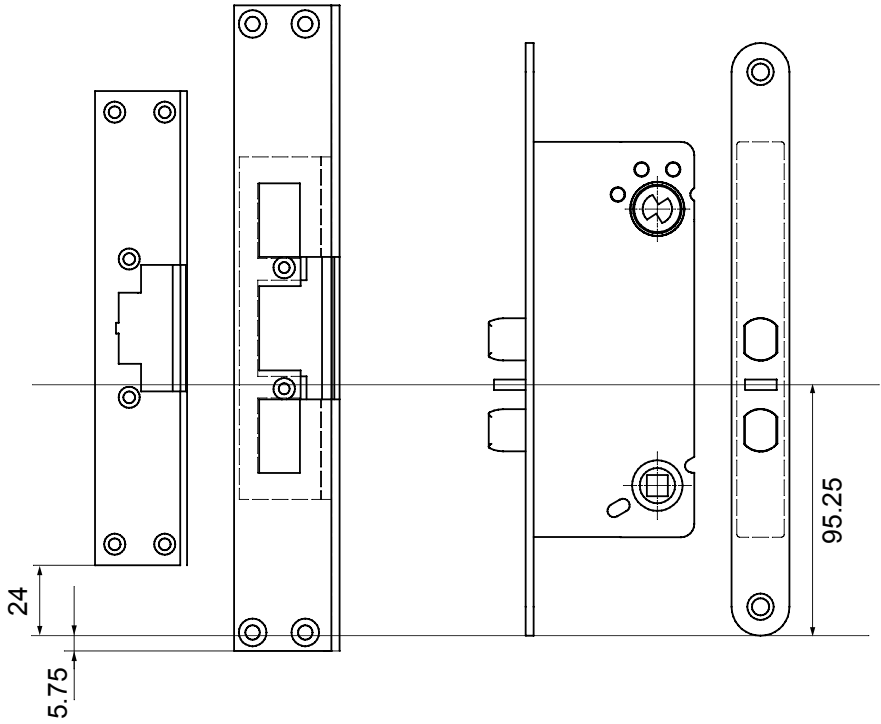

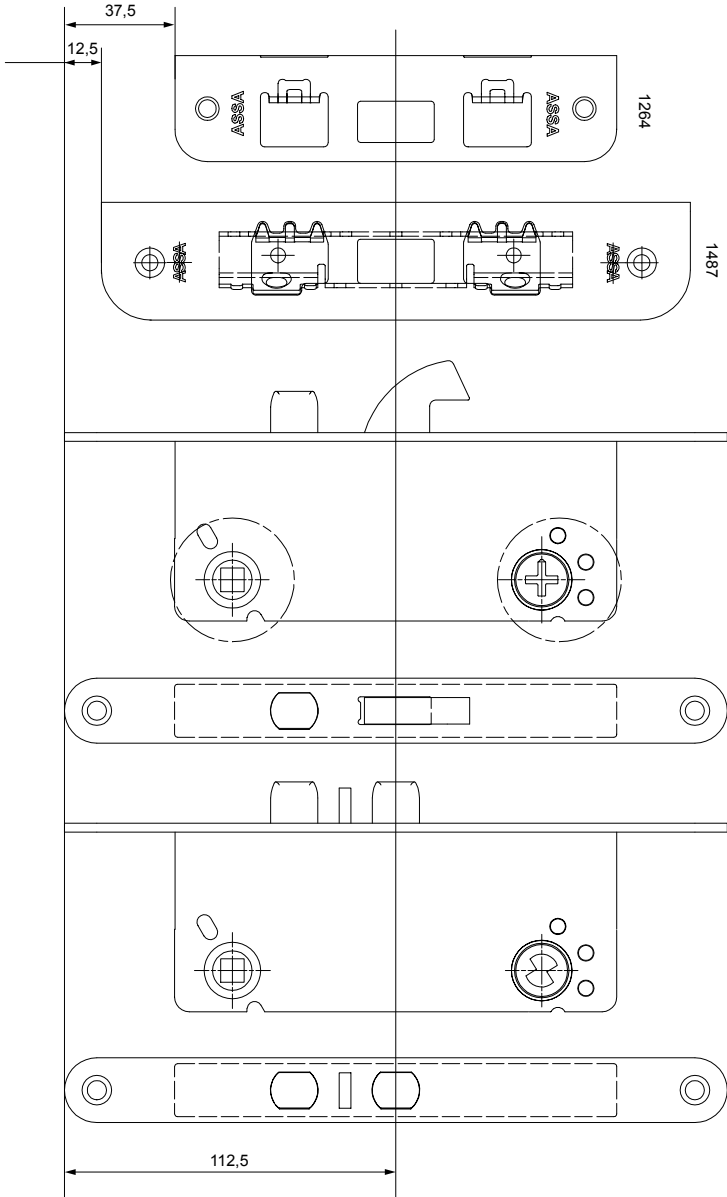

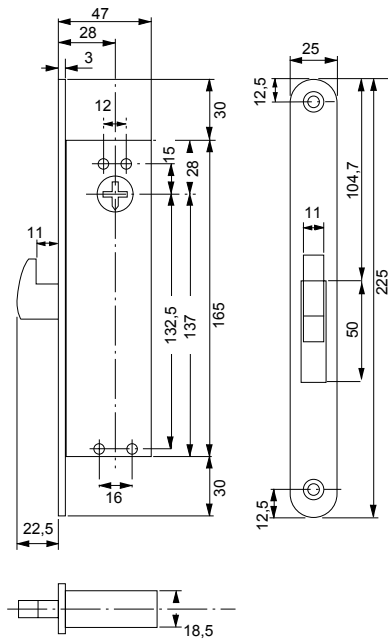
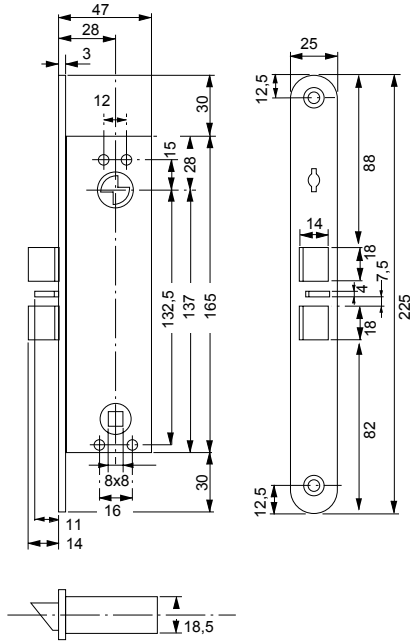

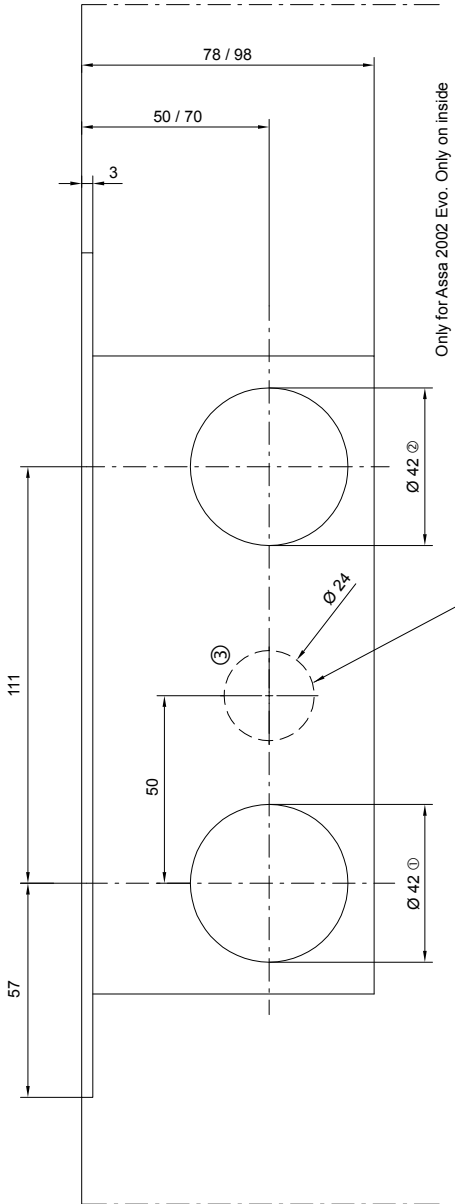

Only for Assa 2002 Evo. Only on inside

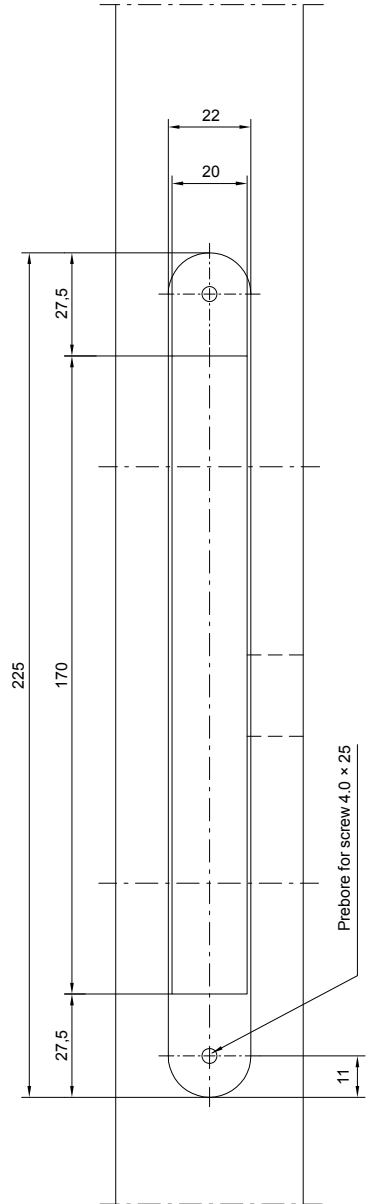

Prebore for screw 4.0 x 25

